

# Ultra Low Output Voltage Linear N-FET Controller

## Features

- 0.5V±1.5% Reference Voltage
- Adjustable Output Voltage Down to 0.5V
- MLCC and POSCAP Stable
- Enable Control
- Power Good Signal Output
- Under Voltage Short Circuit Protection
- Drive N-Channel MOSFETs
- TSOT-23-6 Package

## Applications

- Notebook or Desknote Computers
- Motherboards
- Graphic Cards
- Ultra-Low-Dropout Voltage Regulators

## General Description

The G9336 series are ultra low output voltage linear N-FET controllers designed to simplify power management for notebook computers. Both voltage adjustable (G9336-ADJ) version available for TSOT-23-6 package. The output voltage can be adjusted from 0.5V to 2.5V for G9336-ADJ.

A 0.5V reference voltage with ±1.5% accuracy providing tight regulation of the output voltage, enable control, open drain power good signal, under-voltage protection and soft start.

## Ordering Information

| ORDER NUMBER | MARKING | TEMP. RANGE   | PACKAGE (Green) |
|--------------|---------|---------------|-----------------|
| G9336ADJTP1U | 9336x   | -40°C to 85°C | TSOT-23-6       |

Note:TP:TSOT-23-6

1: Bonding Code

U : Tape & Reel

## Pin Configuration

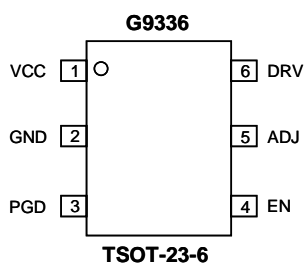

## Typical Application Circuit

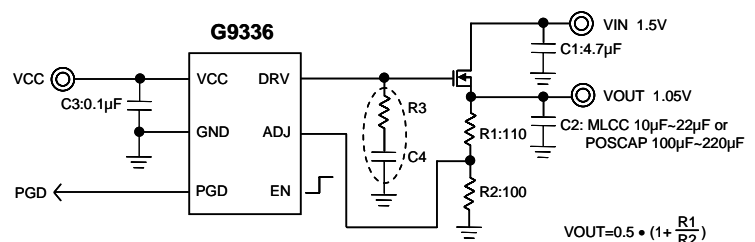

## Absolute Maximum Ratings

VCC, EN, PGD, ADJ, VOUT to GND. . . . -0.3V to +7V  
 DRV to GND . . . . . -0.3V to VCC+0.3V  
 Thermal Resistance Junction to Ambient, ( $\theta_{JA}$ )\*  
 TSOT-23-6 . . . . . 250°C/W  
 Continuous Power Dissipation ( $T_A = +25^\circ\text{C}$ )\*  
 TSOT-23-6 . . . . . 0.5W

Thermal Resistance Junction to Ambient, ( $\theta_{JC}$ )  
 TSOT-23-6 . . . . . 60°C/W  
 Operating Temperature Range . . . . . -40°C to +85°C  
 Junction Temperature. . . . . 125°C  
 Storage Temperature . . . . . -65°C to +150°C  
 Reflow Temperature (soldering, 10sec) . . . . . 260°C

\*Please refer to Minimum Footprint PCB Layout Section.

Stress beyond those listed under "Absolute Maximum Rating" may cause permanent damage to the device.

## Electrical Characteristics

$V_{CC} = V_{EN} = 5V$ ,  $T_A = 25^\circ\text{C}$ .

The device is not guaranteed to function outside its operating conditions. Parameters with MIN and/or MAX limits are 100% tested at +25°C, unless otherwise specified.

| PARAMETER                     | CONDITION   | MIN   | TYP  | MAX   | UNIT          |
|-------------------------------|---|-------|------|-------|---------------|
| Input Voltage Range           | $V_{CC}$  | 4.5   | ---  | 5.5   | V             |
| Quiescent Current             | $I_{Q(STANDBY)}$  | ---   | 350  | 500   | $\mu\text{A}$ |
| Shutdown Current              | $I_{Q(OFF)}$ , $V_{EN} = 0V$                            | -1    | ---  | +1    | $\mu\text{A}$ |
| Input Voltage UVLO Threshold  | $V_{UVLO}$ , $V_{CC}$ rising                            | ---   | 3.75 | ---   | V             |
| Input Voltage UVLO Hysteresis | $V_{HYST}$ , $V_{CC}$ falling                           | ---   | 0.25 | ---   | V             |
| EN Pin Input Voltage High     | $V_{IH}$  | 1.3   | ---  | ---   | V             |
| EN Pin Input Voltage Low      | $V_{IL}$  | ---   | ---  | 0.7   | V             |
| EN Pin Input Current          | $I_{EN}$  | -1    | ---  | +1    | $\mu\text{A}$ |
| ADJ Pin Reference Voltage     | $V_{ADJ}$   | -1.5% | 0.5  | +1.5% | V             |
| ADJ Pin Input Current         | $I_{ADJ}$ , $V_{ADJ} = 0.5V$                            | -100  | ---  | +100  | nA            |
| DRV Pin Output Current        | $I_{DRV(SS)}$ , sourcing, $V_{ADJ} = 0V$ (startup)      | 10    | 20   | 30    | $\mu\text{A}$ |
|                               | $I_{DRV(SRC)}$ , sourcing, $V_{ADJ} = 0.48V$ (normal)   | 1.3   | 1.95 | 2.6   | mA            |
|                               | $I_{DRV(SINK)}$ , sinking, $V_{ADJ} = 0.52V$            | 6     | 9.5  | 13    | mA            |
| DRV Pin Output Voltage        | $V_{DRV}$ , $V_{CC} = 5V$ , $V_{ADJ} = 0.48V$ , no load | 4.9   | ---  | 5     | V             |
| Output Voltage UVLO Threshold | $V_{TH(UV)}$ , measured at ADJ pin                      | 40    | 50   | 60    | % $V_{ADJ}$   |
| Power Good Threshold          | $V_{TH(PGD)}$ , measured at ADJ pin                     | 85    | 88   | 91    | % $V_{ADJ}$   |
| PGD Pin Output Low Voltage    | $I_{PGD} = 1mA$   | ---   | ---  | 0.4   | V             |
| PGD Pin Leakage Current       | $I_{PGD}$ , $V_{ADJ} = 0.5V$ , $V_{PGD} = 6V$           | -1    | ---  | +1    | $\mu\text{A}$ |

### Notes:

1. If  $V_{TH(UV)}$  is exceeded for longer than 50 $\mu\text{s}$  (TYP.) the protection circuitry will shut down the output.
2. During startup only,  $V_{TH(PGD)}$  is 94%(TYP.), then switches to 88% (TYP.).

## Typical Performance Characteristics

VCC=5V; VIN=1.5V; CVCC=0.1μF; CVIN=4.7μF; CVOUT=22μF; TA=25°C

### Load Transient

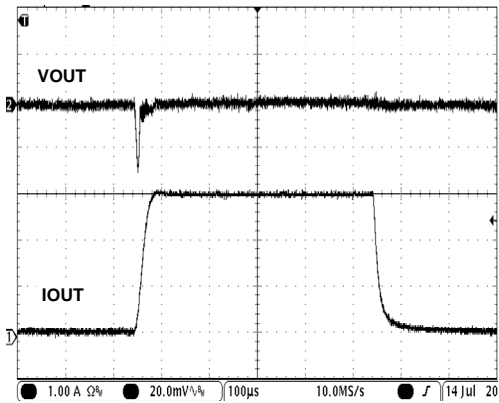

### Power On Sequencing with VCC

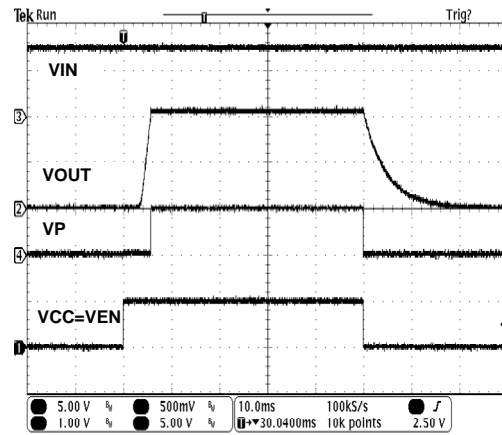

### Power On Sequencing with VIN

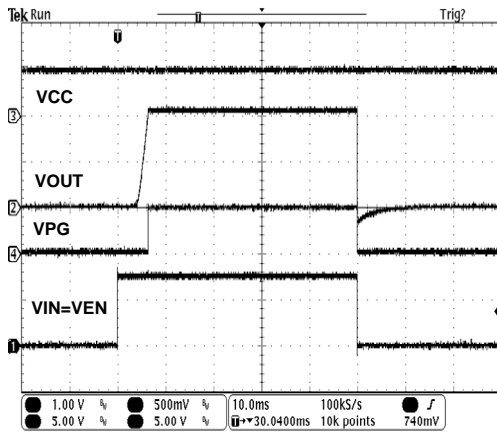

### Enable On Sequencing

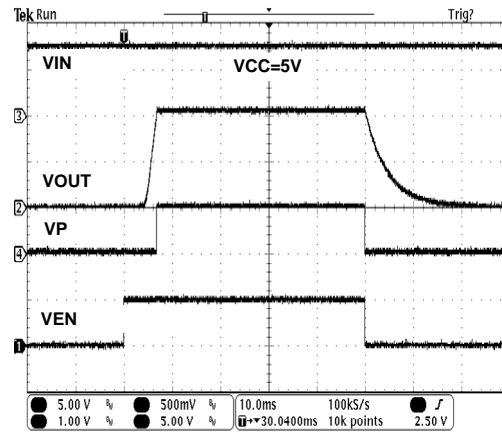

### Short Circuit Protection

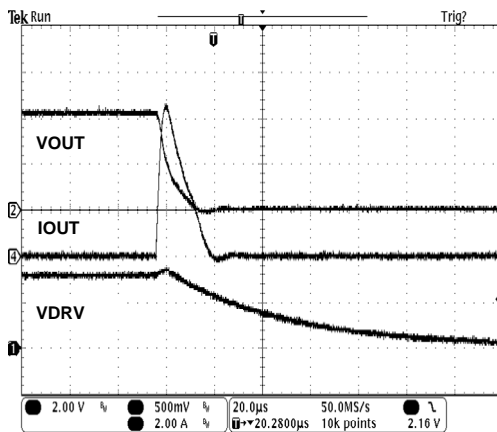

Typical Performance Characteristics (continued)

Output Voltage vs Input Voltage

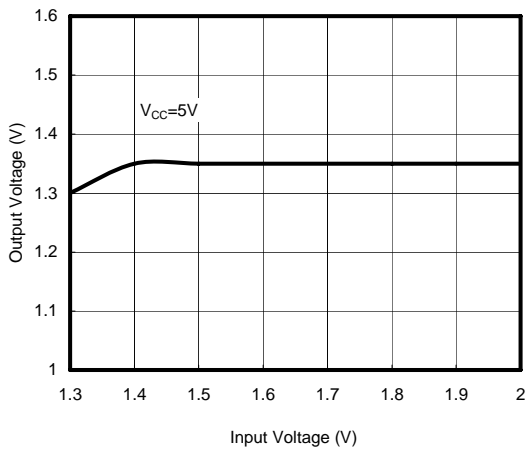

Output Voltage vs Output Current

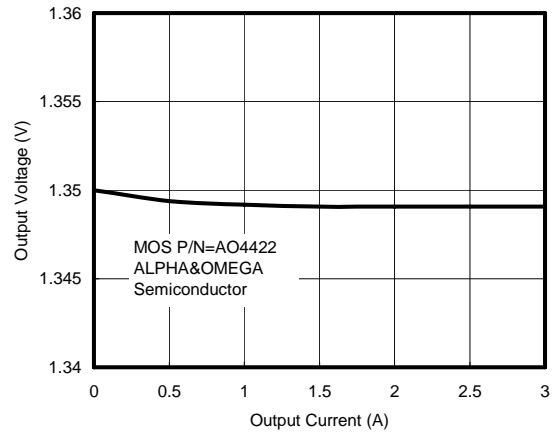

Feedback Voltage vs Temperature

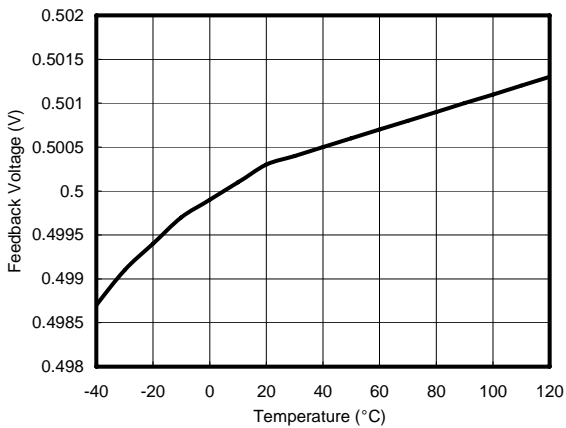

PSRR vs Frequency

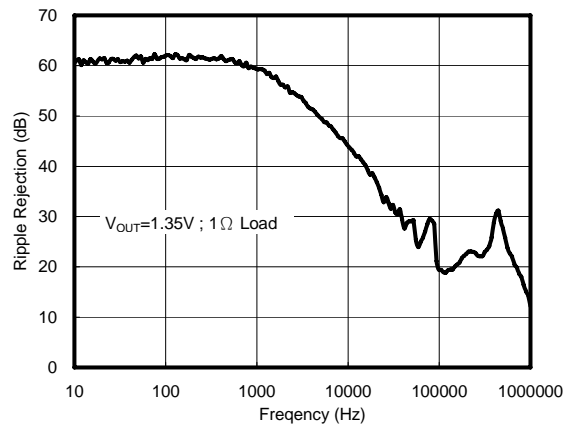

Minimum Footprint PCB Layout Section

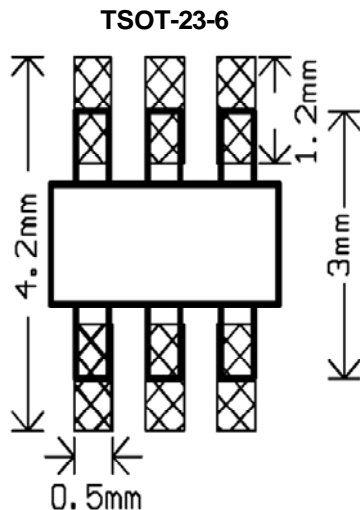

## Pin Descriptions

| PIN | NAME | FUNCTION                                    |
|-----|------|---|
| 1   | VCC  | Power supply                                |
| 2   | GND  | Ground.                                     |
| 3   | PGD  | Open drained power good signal output.      |
| 4   | EN   | Active high enable control.                 |
| 5   | ADJ  | Sense input used for adjust output voltage. |
| 6   | DRV  | Gate drive to N-FET.                        |

## Block Diagram

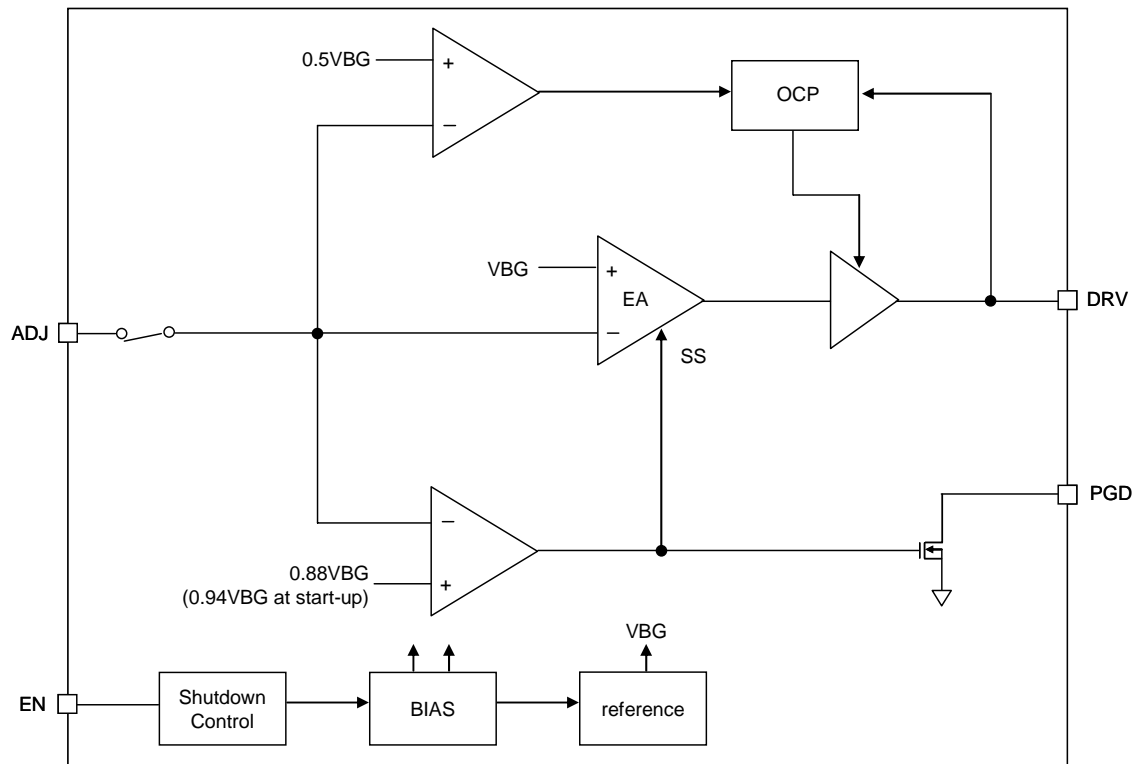

## Function Description

### Normal Operation

The G9336 controls an N-channel MOSFET to produce a tightly regulated output voltage from a higher supply voltage. It takes 5V power supply and draws typically 350µA while operating.

To set the output voltage, feedback the conjunction of a resistor voltage divider from output node to ground for the G9336-ADJ.

The feedback voltage is regulated to compare with the internal 0.5V reference voltage. Depending upon the input voltage used for the device, the DRV pin can pull up to 4.9V. Thus the device can be used to regulate a large range of output voltages by careful selection of the external MOSFETs.

An active high enable control (EN pin) is used to turn on the G9336. If this pin is pulled low, the DRV pin is pulled low, tuning off the N-channel MOSFET. If this pin is pulled higher than 1.3V, the DRV pin is enabled. The EN pin should not be allowed to float.

The G9336 contains a power good output pin (PGD pin) which is an open drain output that pulled low if the output is below the power good threshold (typically 88% of the programmed output voltage, or 94% at the start up). The power good detection is active if the device is enabled, regardless of the state of the over current latch. The power good detector is not active if the output is disabled.

Also included is an over current protection circuit that monitors the output voltage. If the output voltage drops below 50% (typical) of nominal, as would occur during over current or short condition, the device will pull the DRV pin low and latch off. The device will need to have the power supply or EN pin toggled to reset the latch condition.

### Drive Output and Stability Design

The drive output (DRV pin) is sink/source capable. The sink current is typically 9.5mA while the source current is typically 1.8mA in normal operating. At start-up, the source current is limited to 20µA (typical) until the power good threshold (94%) is reached. At this point the full drive capability is enabled.

This drive output is also used for stabilize the loop of the system using different type of output capacitor. For the use of the POSCAPs, the output pole is often designed as a dominant pole of the system. The maximum loading determines the highest frequency of this pole. To cancel the ESR zero of the POSCAPs, add a capacitor from drive output to ground. It makes a pole-zero cancellation. For the use of ceramic capacitors, 10µF~22µF is enough for most of the application. The output pole is often at the higher frequency compare to the POSCAPs. It is not suitable to be arranged as a dominant pole. A resistor-capacitor series should be added from drive pin to ground that creates a pole-zero pair. The pole created at drive pin is designed as the dominant pole of the system, and the zero is to cancel the ceramic capacitors output pole. The components listed in the table below are use for most applications.

|    | MLCC     | POSCAP |
|----|----------|--------|
| C2 | 22µF/X5R | 220µF  |
| R3 | 47Ω      | 0Ω     |
| C4 | 33nF     | 22nF   |
| R2 | 100Ω     | 10kΩ   |

The start-up source current and the loop compensation capacitor (C4) also determine the soft start time  $T_{SS}$ .

$$T_{SS} = \frac{C4 \cdot (0.94 \cdot V_{OUT} + V_{gs})}{20\mu A}, \text{ where } V_{gs} \text{ is depend on N-channel MOSFETs}$$

## OCP

The G9336 has output under voltage protection that look at its output to see if it is:

- (a) less than 50% (typical) of its nominal value and
- (b)  $V_{DRV}$  is within 1V (typical) of its maximum.

If both of these criteria are met, the output is shut down by means of the  $V_{DRV}$  pulled to ground immediately. This provides inherent immunity to under voltage shut down at start up since  $V_{DRV}$  has a very slow rate of rising.

If the 5V VCC input is coming prior to the VIN, it could accidentally meet the OCP fault protection. To avoid entering OCP latch off, using enable control (EN pin) to turn the system on whenever all the power supplies are ready. Alternatively, use a voltage divider (from VCC to VIN) controls enable input, as shown below.

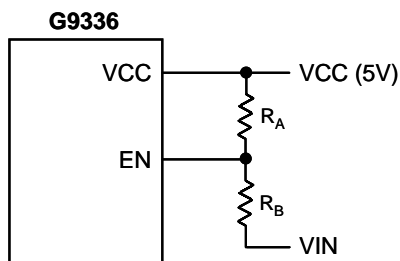

$$\frac{VCC - 0.7}{R_A} = \frac{0.7 - (VOUT / 2)}{R_B}$$
, which VOUT is the target output voltage.

For example, if VCC=5V, VIN=1.2V (later arrival) and the VOUT is to be 1.05V, the equation is reduced to

$R_A/R_B=24.6$ . By choosing correct  $R_A/R_B$  ratio, the G9336 will be turned on when VIN is greater than 50% of the target VOUT. It will avoid the OCP fault protection when starting up. If the VOUT is designed greater than 1.4V, the EN pin can be shorted to VIN that will also not meet the OCP fault protection.

## Component Selection

### Output Capacitor

Low ESR capacitors such as Sanyo POSCAPs or ceramic capacitors are recommended for bulk capacitance.

### Input Capacitor

Low ESR capacitors such as Sanyo POSCAPs or ceramic capacitors will help to hold up the power supply during fast load transients. If  $V_{DRAIN}$  is located at the bulk capacitors of the upstream voltage regulator, additional capacitance may not be required. In this case a 0.1 $\mu$ F ceramic capacitor will suffice. The input supply (VCC) to the G9336 should be bypassed with a 0.1 $\mu$ F ceramic capacitor.

### MOSFETs

Very low or low threshold N-channel MOSFETs are required. For the device to work under all operating conditions, a maximum  $R_{DS(ON)}$  must be met to ensure that the output will never go into dropout:

$$R_{DS(ON)(MAX)} = \frac{VIN_{(MIN)} - VOUT_{(MAX)}}{IOUT_{(PEAK)}}$$

Note that  $R_{DS(ON)}$  must be met at all temperatures.

Power consumptions of the N-channel MOSFETs should be taken into consideration for the selection of various package type.

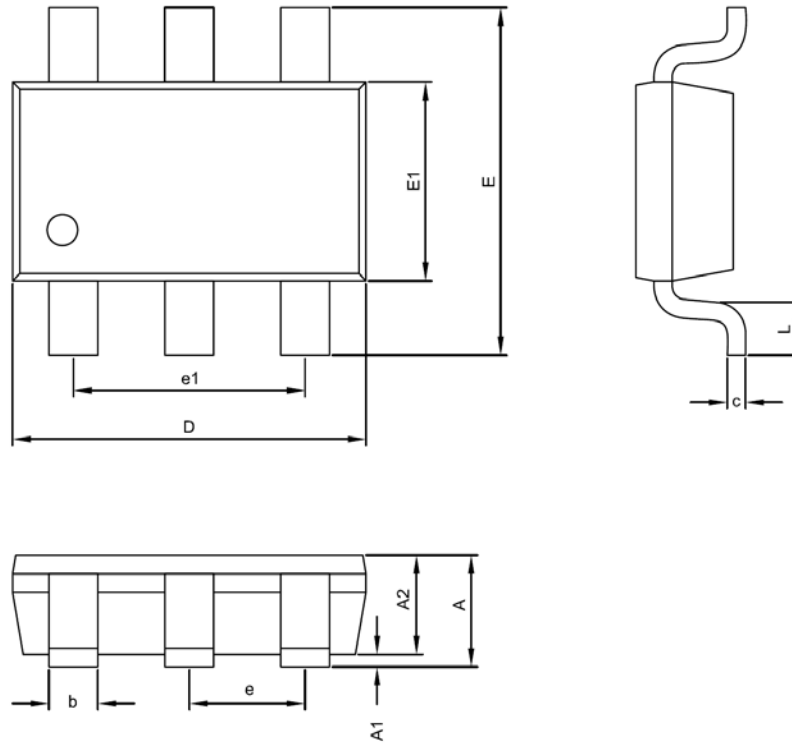
**Package Information**

**TSOT-23-6 (TP) Package**

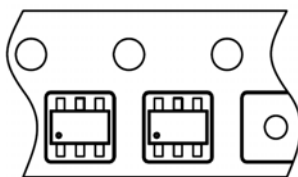
| Symble | DIMENSION IN MM |      |      | DIMENSION IN INCH |       |       |
|--------|-----------------|------|------|-------------------|-------|-------|
|        | MIN.            | NOM. | MAX. | MIN.              | NOM.  | MAX.  |
| A      | ---             | ---  | 1.00 | ---               | ---   | 0.039 |
| A1     | 0.00            | 0.05 | 0.10 | 0.000             | 0.002 | 0.004 |
| A2     | 0.70            | 0.80 | 0.90 | 0.028             | 0.031 | 0.035 |
| D      | 2.70            | 2.90 | 3.10 | 0.106             | 0.114 | 0.122 |
| E      | 2.60            | 2.80 | 3.00 | 0.102             | 0.110 | 0.118 |
| E1     | 1.50            | 1.60 | 1.70 | 0.059             | 0.063 | 0.067 |
| c      | 0.08            | 0.15 | 0.25 | 0.003             | 0.006 | 0.010 |
| b      | 0.30            | 0.40 | 0.50 | 0.012             | 0.016 | 0.020 |
| e      | 0.95 BSC        |      |      | 0.037 BSC         |       |       |
| e1     | 1.90 BSC        |      |      | 0.075 BSC         |       |       |
| L      | 0.30            | 0.45 | 0.60 | 0.012             | 0.018 | 0.024 |

**Taping Specification**

Feed Direction

| PACKAGE   | Q'TY/REEL |
|-----------|-----------|
| TSOT-23-6 | 3,000 ea  |

GMT Inc. does not assume any responsibility for use of any circuitry described, no circuit patent licenses are implied and GMT Inc. reserves the right at any time without notice to change said circuitry and specifications.