



- The author assumes no responsibility for any errors or omissions that may appear in this document nor does the author make a commitment to update the information contained herein.
- Third-party brands and names are the property of their respective owners.
- Please do not remove any labels on motherboard, this may void the warranty of this motherboard.
- Due to rapid change in technology, some of the specifications might be out of date before publication of this booklet.



**WARNING:** Never run the processor without the heatsink properly and firmly attached. PERMANENT DAMAGE WILL RESULT!

**Mise en garde:** Ne faites jamais tourner le processeur sans que le dissipateur de chaleur soit fixé correctement et fermement. UN DOMMAGE PERMANENT EN RÉSULTERA !

**Achtung:** Der Prozessor darf nur in Betrieb genommen werden, wenn der Wärmeleiter ordnungsgemäß und fest angebracht ist. DIES HAT EINEN PERMANENTEN SCHADEN ZUR FOLGE!

**Advertencia:** Nunca haga funcionar el procesador sin el dissipador de calor instalado correcta y firmemente. ¡SE PRODUCIRÁ UN DAÑO PERMANENTE!

**Aviso:** Nunca execute o processador sem o dissipador de calor estar adequado e firmemente conectado. O RESULTADO SERÁ UM DANO PERMANENTE!

**警告:** 將散熱板牢固地安裝到處理器上之前，不要運行處理器。過熱將永遠損壞處理器！

**警告:** 將散熱器牢固地安裝到處理器上之前，不要運行處理器。過熱將永遠損壞處理器！

**경고:** 히트싱크를 제대로 또 단단히 부착시키지 않은 채 프로세서를 구동시키지 마십시오. 영구적 고장이 발생합니다!

**警告:** 永久的な損傷を防ぐため、ヒートシンクを正しくしっかりと取り付けるまでは、プロセッサを動作させないようにしてください。

## Declaration of Conformity

We, Manufacturer/Importer  
(full address)

**G.B.T. Technology Trading GmbH**  
Ausschlagweg 41, 1F, 20537 Hamburg, Germany

declare that the product  
( description of the apparatus, system, installation to which it refers)

### Mother Board

GA-8S650GXM ( Rev 2.0)  
is in conformity with

(reference to the specification under which conformity is declared)  
in accordance with 89/336 EEC-EMC Directive

<input type="checkbox"/> EN 55011	Limits and methods of measurement of radio disturbance characteristics of industrial, scientific and medical (ISM) high frequency equipment	<input type="checkbox"/> EN 61000-3-2* <input checked="" type="checkbox"/> EN 60555-2	Disturbances in supply systems cause by household appliances and similar electrical equipment "Harmonics"
<input type="checkbox"/> EN 55013	Limits and methods of measurement of radio disturbance characteristics of broadcast receivers and associated equipment	<input type="checkbox"/> EN 61000-3-3* <input checked="" type="checkbox"/> EN 60555-3	Disturbances in supply systems cause by household appliances and similar electrical equipment "Voltage fluctuations"
<input type="checkbox"/> EN 55014	Limits and methods of measurement of radio disturbance characteristics of household electrical appliances, portable tools and similar electrical apparatus	<input checked="" type="checkbox"/> EN 50081-1 <input checked="" type="checkbox"/> EN 50082-1	Generic emission standard Part 1: Residual commercial and light industry  Generic immunity standard Part 1: Residual commercial and light industry
<input type="checkbox"/> EN 55015	Limits and methods of measurement of radio disturbance characteristics of fluorescent lamps and luminaries	<input type="checkbox"/> EN 55081-2	Generic emission standard Part 2: Industrial environment
<input type="checkbox"/> EN 55020	Immunity from radio interference of broadcast receivers and associated equipment	<input type="checkbox"/> EN 55082-2	Generic emission standard Part 2: Industrial environment
<input checked="" type="checkbox"/> EN 55022	Limits and methods of measurement of radio disturbance characteristics of information technology equipment	<input type="checkbox"/> ENV 55104	Immunity requirements for household appliances tools and similar apparatus
<input type="checkbox"/> DIN VDE 0855 <input type="checkbox"/> part 10 <input type="checkbox"/> part 12	Cabled distribution systems; Equipment for receiving and/or distribution from sound and television signals	<input type="checkbox"/> EN 50091-2	EMC requirements for uninterruptible power systems (UPS)
<input checked="" type="checkbox"/> CE marking			(EC conformity marking)
<b>The manufacturer also declares the conformity of above mentioned product with the actual required safety standards in accordance with LVD 73/23 EEC</b>			
<input type="checkbox"/> EN 60065	Safety requirements for mains operated electronic and related apparatus for household and similar general use	<input type="checkbox"/> EN 60950	
<input type="checkbox"/> EN 60335	Safety of household and similar electrical appliances	<input type="checkbox"/> EN 50091-1	

Manufacturer/Importer

(Stamp)

Date : October 17, 2003

Signature: Timmy Huang  
Name: Timmy Huang

## DECLARATION OF CONFORMITY

Per FCC Part 2 Section 2.1077(a)



**Responsible Party Name: G.B.T. INC. (U.S.A.)**

**Address: 17358 Railroad Street  
City of Industry, CA 91748**

**Phone/Fax No: (818) 854-9338/ (818) 854-9339**

hereby declares that the product

**Product Name: Motherboard**

**Model Number: GA-8S650GXM (Rev 2.0)**

Conforms to the following specifications:

FCC Part 15, Subpart B, Section 15.107(a) and Section 15.109(a),  
Class B Digital Device

### **Supplementary Information:**

This device complies with part 15 of the FCC Rules. Operation is subject to the following two conditions: (1) This device may not cause harmful and (2) this device must accept any interference received, including that may cause undesired operation.

Representative Person's Name: ERIC LU

Signature: Eric Lu

Date: October 17, 2003

GA-8S650GXM (-P/-P-C)  
P4 Titan Series Motherboard

# USER'S MANUAL

Pentium®4 Processor Motherboard  
Rev.2001  
12ME-8S650GXM-2001

## Table of Content

Item Checklist .....	4
Chapter 1 Introduction .....	5
Features Summary .....	5
GA-8S650GXM (-P/-P-C) Motherboard Layout .....	7
Block Diagram .....	8
Chapter 2 Hardware Installation Process .....	10
Step 1: Install the Central Processing Unit (CPU) .....	11
Step 1-1: CPU Installation .....	11
Step 1-2: CPU Cooling Fan Installation .....	12
Step 2: Install memory modules .....	13
Step 3: Install expansion cards .....	15
Step 4: Connect ribbon cables, cabinet wires, and power supply .....	16
Step 4-1: I/O Back Panel Introduction .....	16
Step 4-2: Connectors & Jumper Setting Introduction .....	18
Chapter 3 BIOS Setup .....	31
The Main Menu (For example: BIOS Ver. : F1) .....	32
Standard CMOS Features .....	34
Advanced BIOS Features .....	37
Integrated Peripherals .....	39
Power Management Setup .....	43

PnP/PCI Configurations .....	45
PC Health Status .....	46
Frequency/Voltage Control .....	48
Top Performance .....	50
Load Fail-Safe Defaults .....	51
Load Optimized Defaults .....	52
Set Supervisor/User Password .....	53
Save & Exit Setup .....	54
Exit Without Saving .....	55
Chapter 4 Technical Reference .....	57
@ BIOS™ Introduction .....	57
Easy Tune™ 4 Introduction .....	58
Flash BIOS Method Introduction .....	59
2-/4-/6-Channel Audio Function Introduction .....	74
Chapter 5 Appendix .....	81

## Item Checklist

- |   |   |
|---|---|
| <input checked="" type="checkbox"/> The GA-8S650GXM (-P/-P-C) motherboard | <input type="checkbox"/> 2 Port USB Cable x 1           |
| <input checked="" type="checkbox"/> IDE cable x 1/ Floppy cable x 1       | <input type="checkbox"/> 4 Port USB Cable x 1           |
| <input checked="" type="checkbox"/> CD for motherboard driver & utility   | <input type="checkbox"/> SPDIF-KIT x 1 (SPDIF Out KIT)  |
| <input checked="" type="checkbox"/> GA-8S650GXM (-P/-P-C) user's manual   | <input type="checkbox"/> IEEE 1394 Cable x1             |
| <input checked="" type="checkbox"/> I/O Shield <sup>(Ⓢ)</sup>             | <input type="checkbox"/> Audio Combo Kit x 1            |
| <input type="checkbox"/> Quick PC Installation Guide                      | <input type="checkbox"/> (SURROUND-Kit + SPDIF Out KIT) |
| <input type="checkbox"/> RAID Manual                                      | <input type="checkbox"/> Motherboard Settings Label     |



### CAUTION

Computer motherboards and expansion cards contain very delicate Integrated Circuit (IC) chips. To protect them against damage from static electricity, you should follow some precautions whenever you work on your computer.

1. Unplug your computer when working on the inside.
2. Use a grounded wrist strap before handling computer components. If you do not have one, touch both of your hands to a safely grounded object or to a metal object, such as the power supply case.
3. Hold components by the edges and try not to touch the IC chips, leads or connectors, or other components.
4. Place components on a grounded antistatic pad or on the bag that came with the components whenever the components are separated from the system.
5. Ensure that the ATX power supply is switched off before you plug in or remove the ATX power connector on the motherboard.

### Installing the motherboard to the chassis...

If the motherboard has mounting holes, but they don't line up with the holes on the base and there are no slots to attach the spacers, do not become alarmed you can still attach the spacers to the mounting holes. Just cut the bottom portion of the spacers (the spacer may be a little hard to cut off, so be careful of your hands). In this way you can still attach the motherboard to the base without worrying about short circuits. Sometimes you may need to use the plastic springs to isolate the screw from the motherboard PCB surface, because the circuit wire may be near by the hole. Be careful, don't let the screw contact any printed circuit wire or parts on the PCB that are near the fixing hole, otherwise it may damage the board or cause board malfunctioning.

Ⓢ For GA-8S650GXM-P only.



## Chapter 1 Introduction

### Features Summary

Form Factor	<ul style="list-style-type: none"> <li>• 24.4cm x 21.5cm Micro ATX size form factor, 4 layers PCB.</li> </ul>
CPU	<ul style="list-style-type: none"> <li>• Socket 478 for Intel® Micro FC-PGA2 Pentium® 4 processor</li> <li>• Support Intel® Pentium® 4 (Northwood, 0.13µm) processor</li> <li>• Intel Pentium® 4 400/533 MHz FSB</li> <li>• 2nd cache depends on CPU</li> </ul>
Chipset	<ul style="list-style-type: none"> <li>• SiS 650GX Host/Memory controller</li> <li>• SiS 962L MuTIOL Media IO</li> </ul>
Memory	<ul style="list-style-type: none"> <li>• 2 184-pin DDR sockets</li> <li>• Supports DDR200/DDR266/DDR333</li> <li>• Supports up to 2 un-buffer Double-sided DIMM DDR200/266 /333</li> <li>• Supports up to 2GB (Max)</li> <li>• Supports only 2.5V DDR DIMM</li> </ul>
I/O Control	<ul style="list-style-type: none"> <li>• W83697HF</li> </ul>
Slots	<ul style="list-style-type: none"> <li>• 1 Universal AGP slot (2X/4X) device support</li> <li>• 3 PCI slot supports 33MHz &amp; PCI 2.2 compliant</li> </ul>
On-Board IDE	<ul style="list-style-type: none"> <li>• 2 IDE bus master (UDMA33/ATA66/ATA100/ATA133) IDE ports for up to 4 ATAPI devices</li> <li>• Supports PIO mode 3,4 (UDMA33/ATA66/ATA100/ATA133) IDE &amp; ATAPI CD-ROM</li> </ul>
On-Board Peripherals	<ul style="list-style-type: none"> <li>• 1 Floppy port supports 2 FDD with 360K, 720K, 1.2M, 1.44M and 2.88M bytes.</li> <li>• 1 Parallel port supports Normal/EPP/ECP mode</li> <li>• 1 Serial port (COMA), 1 VGA port, COMB on board</li> <li>• 6 x USB 2.0/1.1 (2 x Rear, 4 x Front by cable)</li> <li>• 1 Front Audio Connector</li> <li>• 1 IrDA connector for IR</li> </ul>

to be continued.....

Hardware Monitor	<ul style="list-style-type: none"> <li>• CPU/System Fan Revolution detect</li> <li>• CPU/System Fan Control</li> <li>• CPU Overheat Warning</li> <li>• System Voltage Detect</li> </ul>
On-Board Sound	<ul style="list-style-type: none"> <li>• Realtek ALC655 CODEC</li> <li>• Line Out / 2 front speaker</li> <li>• Line In / 2 rear speaker (by s/w switch)</li> <li>• Mic In / center &amp; subwoofer (by s/w switch)</li> <li>• SPDIF Out / SPDIF In</li> <li>• CD_In / Game Port</li> </ul>
On-Board LAN <sup>(①)</sup>	<ul style="list-style-type: none"> <li>• Build in RTL8201 Chipset</li> </ul>
On-Board VGA	<ul style="list-style-type: none"> <li>• Build in SiS650GX Chipset</li> </ul>
PS/2 Connector	<ul style="list-style-type: none"> <li>• PS/2 Keyboard interface and PS/2 Mouse interface</li> </ul>
BIOS	<ul style="list-style-type: none"> <li>• Licensed Award BIOS</li> <li>• Supports Q-Flash</li> </ul>
Additional Features	<ul style="list-style-type: none"> <li>• PS/2 Keyboard power on by password</li> <li>• PS/2 Mouse power on</li> <li>• STR (Suspend-To-RAM)</li> <li>• AC Recovery</li> <li>• USB KB/Mouse wake up from S3</li> <li>• Supports EasyTune 4</li> <li>• Supports @BIOS</li> </ul>



Please set the CPU host frequency in accordance with your processor's specifications. We don't recommend you to set the system bus frequency over the CPU's specification because these specific bus frequencies are not the standard specifications for CPU, chipset and most of the peripherals. Whether your system can run under these specific bus frequencies properly will depend on your hardware configurations, including CPU, Chipsets, Memory, Cards....etc.

① For GA-8S650GXM-P only.

### GA-8S650GXM (-P/-P-C) Motherboard Layout

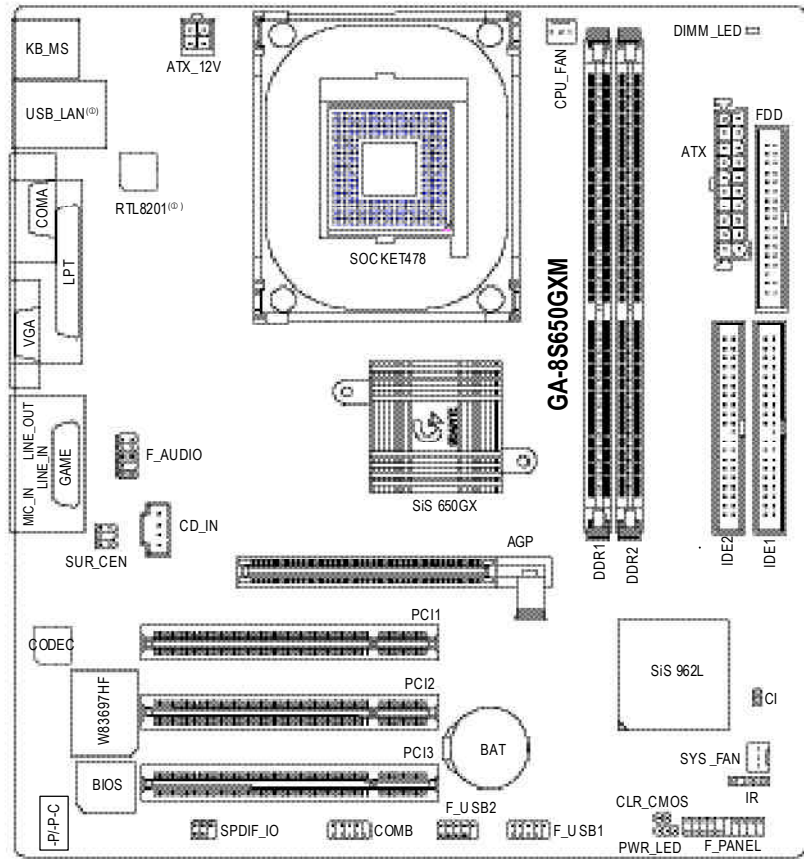

Ⓞ For GA-8S650GXM-P only.

## Block Diagram

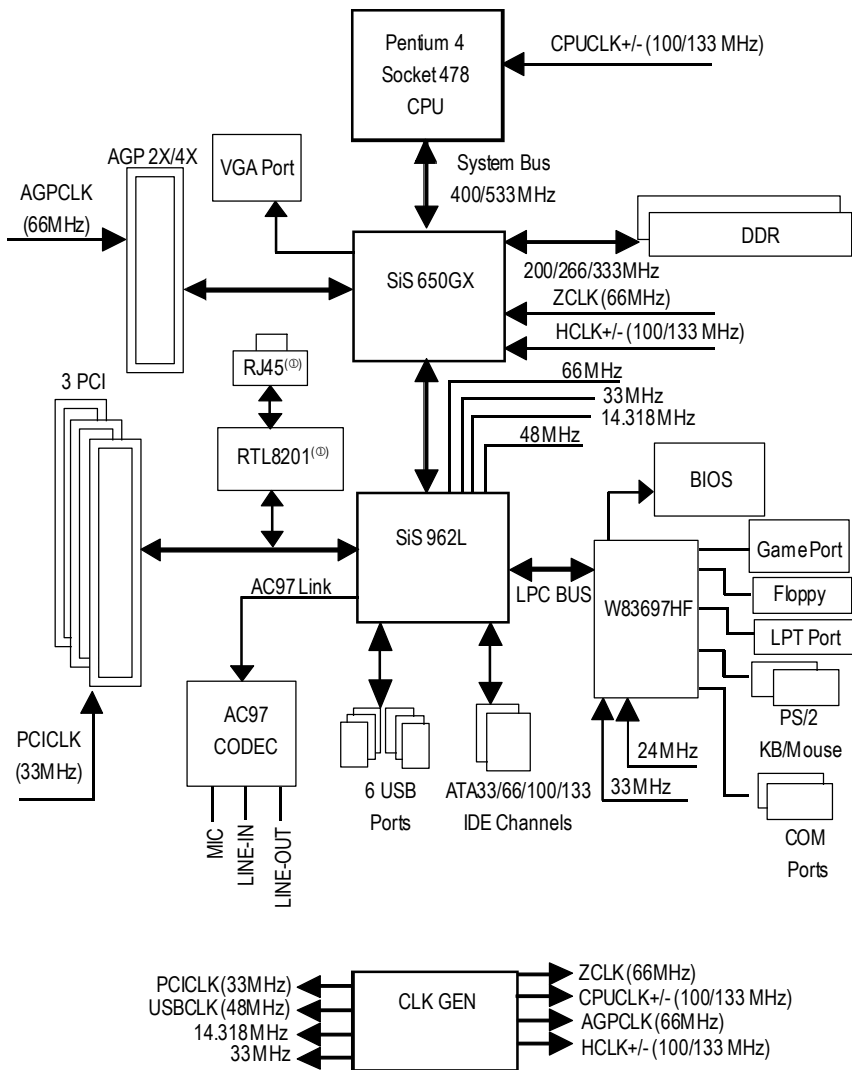

© For GA-8S650GXM-P only.



## Chapter 2 Hardware Installation Process

To set up your computer, you must complete the following steps:

- Step 1- Install the Central Processing Unit (CPU)
- Step 2- Install memory modules
- Step 3- Install expansion cards
- Step 4- Connect ribbon cables, cabinetwires, and power supply

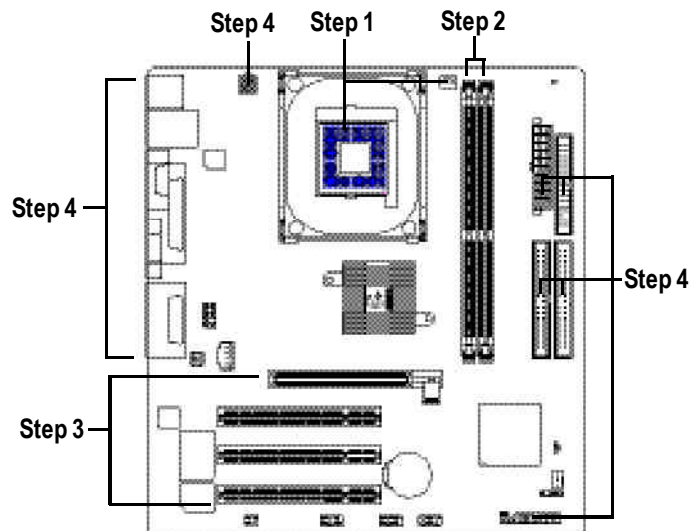

Congratulations you have accomplished the hardware installation!

Turn on the power supply or connect the power cable to the power outlet. Continue with the BIOS/ software installation.

## Step 1: Install the Central Processing Unit (CPU)

Before installing the processor, adhere to the following warning:



If you do not match the CPU socket Pin 1 and CPU cut edge well, it will cause improper installation. Please change the insert orientation.

Please make sure the CPU type is supported by the motherboard.

### Step 1-1: CPU Installation

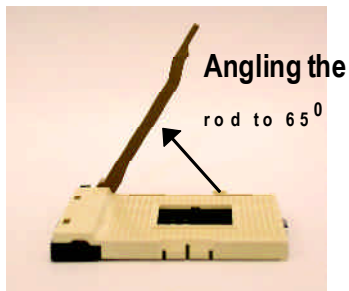

1. Angling the rod to 65-degree maybe feel a kind of tight, and then continue pull the rod to 90-degree when a noise "cough" made.

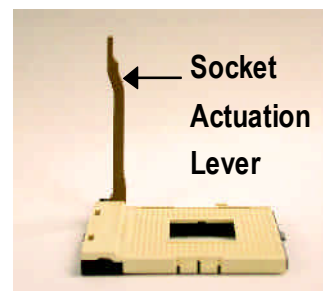

2. Pull the rod to the 90-degree directly.



3. CPU Top View

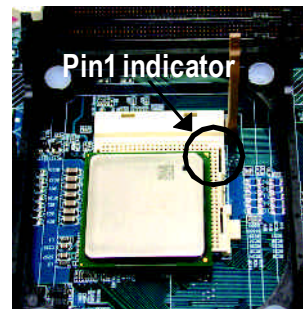

4. Locate Pin 1 in the socket and look for a (golden) cut edge on the CPU upper corner. Then insert the CPU into the socket.

## Step 1-2 : CPU Cooling Fan Installation



Before installing the CPU cool fan , adhere to the following warning:

1. Please use Intel approved cooling fan.
2. We recommend you to apply the thermal tape to provide better heat conduction between your CPU and cooling fan.  
(The CPU cooling fan might stick to the CPU due to the hardening of the thermal paste. During this condition if you try to remove the cooling fan, you might pull the processor out of the CPU socket alone with the cooling fan, and might damage the processor. To avoid this from happening, we suggest you to either use thermal tape instead of thermal paste, or remove the cooling fan with extreme caution.)
3. Make sure the CPU fan power cable is plugged in to the CPU fan connector, this completes the installation. Please refer to CPU cooling fan user's manual for more detail installation procedure.

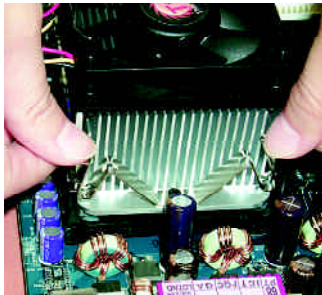

1. Fasten the cooling fan supporting-base onto the CPU socket on the motherboard.

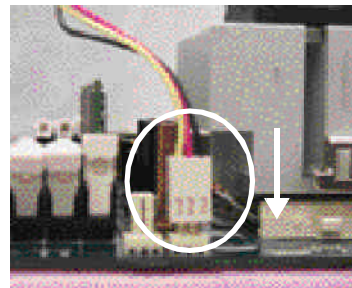

2. Make sure the CPU fan is plugged to the CPU fan connector, than install complete.



## Step 2: Install memory modules



**Before installing the processor and heatsink, adhere to the following warning:**

When DIMM\_LED is ON, do not install/remove DIMM from socket.

Please note that the DIMM module can only fit in one direction due to the one notches.

Wrong orientation will cause improper installation. Please change the insert orientation.

The motherboard has 2 dual inline memory module (DIMM) sockets. The BIOS will automatically detects memory type and size. To install the memory module, just push it vertically into the DIMM socket. The DIMM module can only fit in one direction due to the notch. Memory size can vary between sockets.

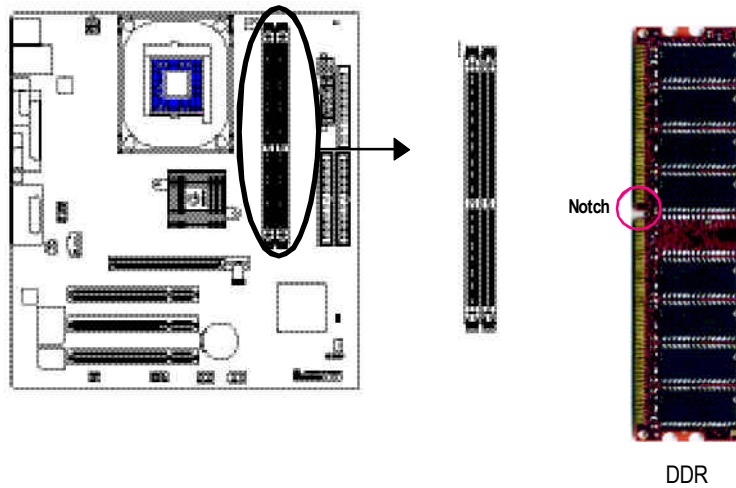

Support Unbuffered DDR DIMM Sizes type:

64 Mbit (2Mx8x4 banks)	64 Mbit (1Mx16x4 banks)	128 Mbit(4Mx8x4 banks)
128 Mbit(2Mx16x4 banks)	256 Mbit(8Mx8x4 banks)	256 Mbit(4Mx16x4 banks)
512 Mbit(16Mx8x4 banks)	512 Mbit(8Mx16x4 banks)	

1. The DIMM slot has a notch, so the DIMM memory module can only fit in one direction.



2. Insert the DIMM memory module vertically into the DIMM slot. Then push it down.



3. Close the plastic clip at both edges of the DIMM slots to lock the DIMM module. Reverse the installation steps when you wish to remove the DIMM module.



### DDR Introduction

Established on the existing SDRAM infrastructure, DDR (Double Data Rate) memory is a high performance and cost-effective solution that allows easy adoption for memory vendors, OEMs, and system integrators.

DDR memory is a great evolutionary solution for the PC industry that builds on the existing SDRAM architecture, yet make the awesome advances in solving the system performance bottleneck by doubling the memory bandwidth. Nowadays, with the highest bandwidth of 3.2GB/s of DDR400 memory and complete line of DDR400/333/266/200 memory solutions, DDR memory is the best choice for building high performance and low latency DRAM subsystem that are suitable for servers, workstations, and full range of desktop PCs.

### Step 3: Install expansion cards

1. Read the related expansion card's instruction document before install the expansion card into the computer.
2. Remove your computer's chassis cover, necessary screws and slot bracket from the computer.
3. Press the expansion card firmly into expansion slot in motherboard.
4. Be sure the metal contacts on the card are indeed seated in the slot.
5. Replace the screw to secure the slot bracket of the expansion card.
6. Replace your computer's chassis cover.
7. Power on the computer, if necessary, setup BIOS utility of expansion card from BIOS.
8. Install related driver from the operating system.

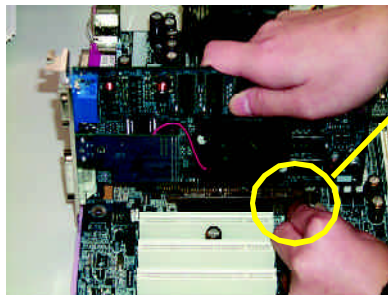

AGP Card

Please carefully pull out the small white-drawable bar at the end of the AGP slot when you try to install/ Uninstall the AGP card. Please align the AGP card to the onboard AGP slot and press firmly down on the slot. Make sure your AGP card is locked by the small white-drawable bar.

## Step 4: Connect ribbon cables, cabinet wires, and power supply

### Step 4-1: I/O Back Panel Introduction

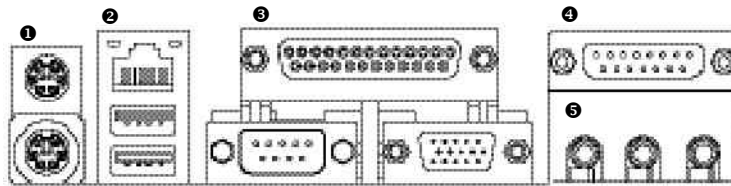

#### ❶ PS/2 Keyboard and PS/2 Mouse Connector



PS/2 Mouse Connector  
(6 pin Female)

PS/2 Keyboard Connector  
(6 pin Female)

➤ This connector supports standard PS/2 keyboard and PS/2 mouse.

#### ❷ USB & LAN Connector

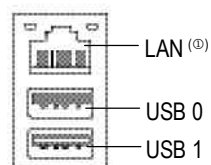

LAN <sup>①</sup>

USB 0

USB 1

➤ Before you connect your device(s) into USB connector(s), please make sure your device(s) such as USB keyboard, mouse, scanner, zip, speaker...etc. Have a standard USB interface. Also make sure your OS supports USB controller. If your OS does not support USB controller, please contact OS vendor for possible patch or driver upgrade. For more information please contact your OS or device(s) vendors.

① For GA-8S650GXM-P only.

**③ Parallel Port , Serial Port and VGA Port (LPT/COMA/VGA)**

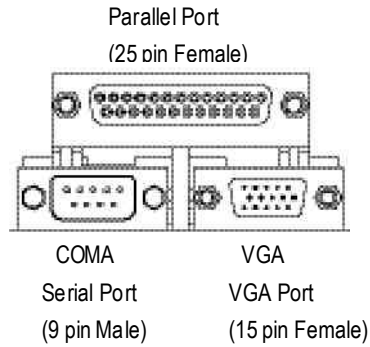

- This connector supports 1 standard COM port, 1 Parallel port and 1 VGA port. Device like printer can be connected to Parallel port; mouse and modem etc can be connected to Serial ports.

**④ Game /MIDI Ports**

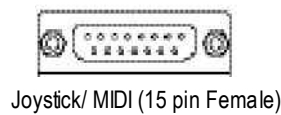

- This connector supports joystick, MIDI keyboard and other relate audio devices.

**⑤ Audio Connectors**

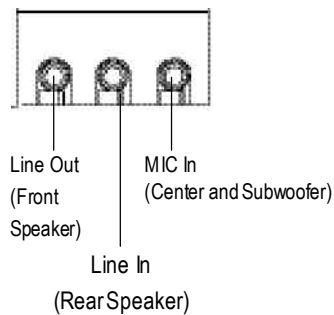

- After install onboard audio driver, you may connectspeaker to Line Outjack, micro phone to MIC In jack. Device like CD-ROM , walkman etc can be connected to Line-In jack. Please note: You are able to use 2-/4-/6- channel audio feature by S/W selection. If you want to enable 6-channel function, you have 2 choose for hardware connection.

**Method1:**

- Connect "FrontSpeaker" to "Line Out"
- Connect "Rear Speaker" to "Line In"
- Connect "Center and Subwoofer" to "MIC Out".

**Method2:**

- You can refer to page 25, and contact your nearest dealer for optional SUR\_CEN cable.



**If you want the detail information for 2-/4-/6-channel audio setup installation, please refer to page 74.**

## Step 4-2: Connectors &amp; Jumper Setting Introduction

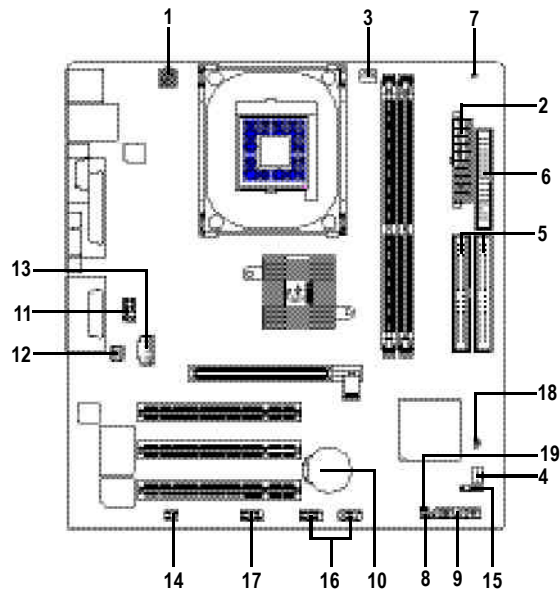

1) ATX_12V	12) SUR_CEN
2) ATX	13) CD_IN
3) CPU_FAN	14) SPDIF_IO
4) SYS_FAN	15) IR
5) IDE1/IDE2	16) F_USB1/F_USB2
6) FDD	17) COMB
7) DIMM_LED	18) CI
8) PWR_LED	19) CLR_CMOS
9) F_PANEL	
10) BAT	
11) F_AUDIO	

**1) ATX\_12V(+12V Power Connector)**

This connector (ATX\_12V) supplies the CPU operation voltage (Vcore). If this "ATX\_12V connector" is not connected, system cannot boot.

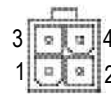
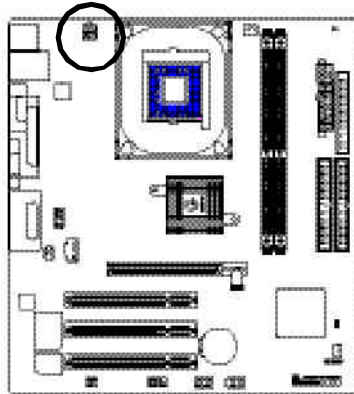

Pin No.	Definition
1	GND
2	GND
3	+12V
4	+12V

**2) ATX (ATX Power)**

AC power cord should only be connected to your power supply unit after ATX power cable and other related devices are firmly connected to the mainboard.

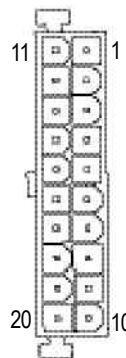
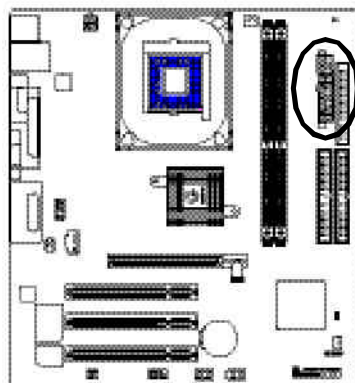

Pin No.	Definition
1	3.3V
2	3.3V
3	GND
4	VCC
5	GND
6	VCC
7	GND
8	PowerGood
9	5V SB(stand by +5V)
10	+12V
11	3.3V
12	-12V
13	GND
14	PS_ON(soft On/Off)
15	GND
16	GND
17	GND
18	-5V
19	VCC
20	VCC

### 3) CPU\_FAN (CPU FAN Connector)

Please note, a proper installation of the CPU cooler is essential to prevent the CPU from running under abnormal condition or damaged by overheating. The CPU fan connector supports Max. current up to 600 mA.

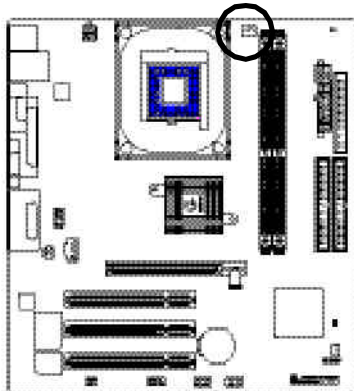

PinNo.	Definition
1	GND
2	+12V
3	Sense

### 4) SYS\_FAN (System FAN Connector)

This connector allows you to link with the cooling fan on the system case to lower the system temperature.

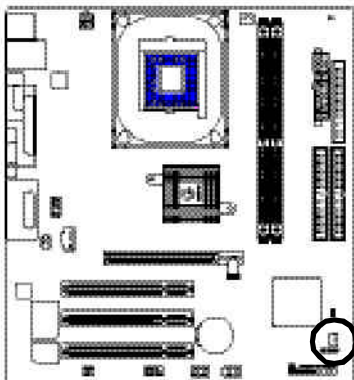

PinNo.	Definition
1	GND
2	+12V
3	Sense



5) IDE1/ IDE2(IDE1/IDE2 Connector)

Please connect first harddisk to IDE1 and connect CDROM to IDE2. The red stripe of the ribbon cable must be the same side with the Pin1.

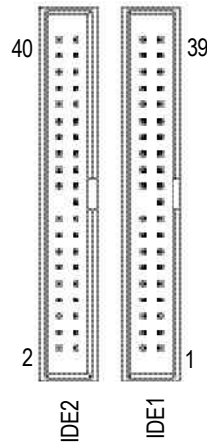
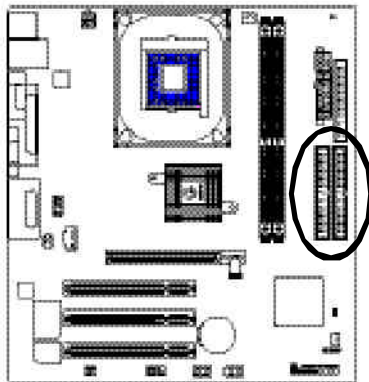

6) FDD (Floppy Connector)

Please connect the floppy drive ribbon cables to FDD. It supports 360K,720K,1.2M,1.44M and 2.88Mbytes floppy disk types. The red stripe of the ribbon cable must be the same side with the Pin1.

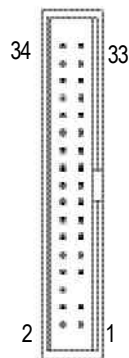
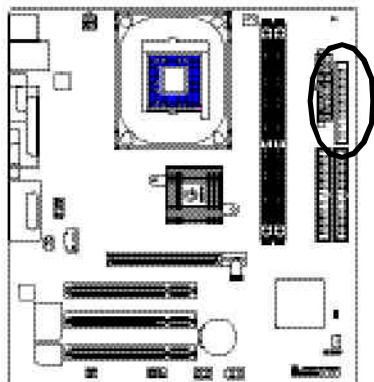

**7) DIMM\_LED**

Do not remove memory modules while DIMM LED is on. It might cause short or other unexpected damages due to the 2.5V stand by voltage. Remove memory modules only when AC Power cord is disconnected.

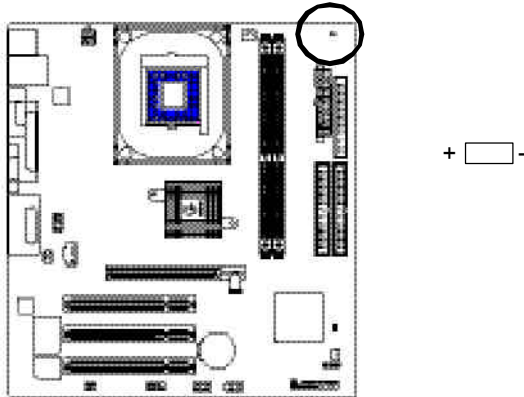

**8) PWR\_LED**

PWR\_LED is connect with the system power indicator to indicate whether the system is on/off. It will blink when the system enters suspend mode. If you use dual color LED, power LED will turn to another color.

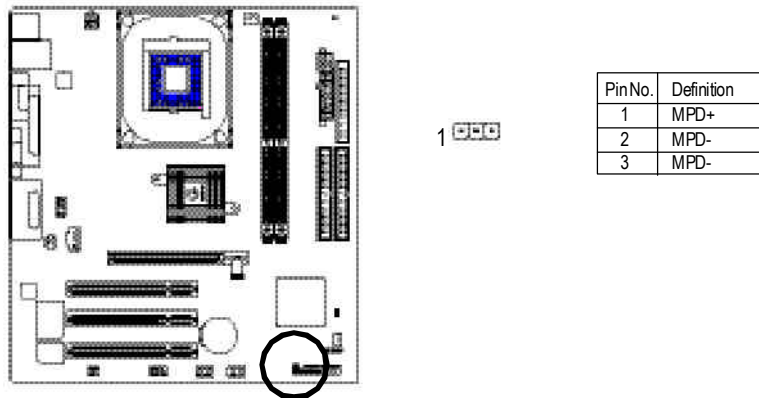

9) **F\_PANEL (2x10 pins connector)**

Please connect the power LED, PC peaker, resetswitch and power switch etc of your chassis front panel to the F\_PANEL connector according to the pin assignment above.

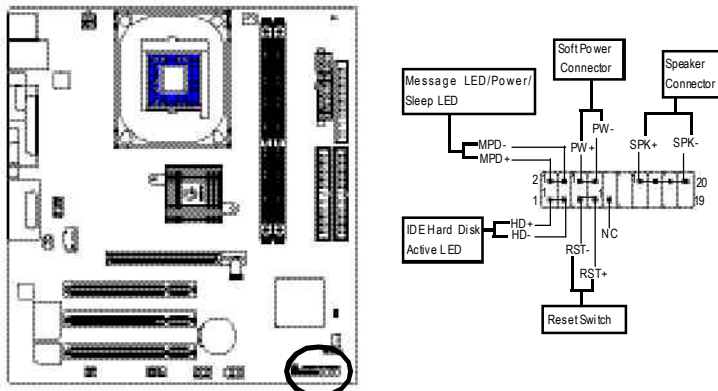

HD (IDE Hard Disk Active LED)	Pin 1: LED anode(+) Pin 2: LED cathode(-)
SPK (Speaker Connector)	Pin 1: VCC(+) Pin 2- Pin 3: NC Pin 4: Data(-)
RST (Reset Switch)	Open: Normal Operation Close: Reset Hardware System
PW (Soft Power Connector)	Open: Normal Operation Close: Power On/Off
MPD (Message LED/Power/Sleep LED)	Pin 1: LED anode(+) Pin 2: LED cathode(-)
NC	NC

### 10) BAT (Battery)

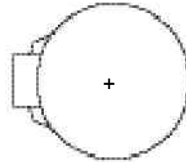
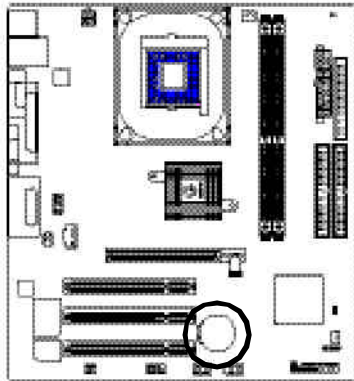

**CAUTION**

- ❖ Danger of explosion if battery is incorrectly replaced.
- ❖ Replace only with the same or equivalent type recommended by the manufacturer.
- ❖ Dispose of used batteries according to the manufacturer's instructions.

If you want to erase CMOS...

1. Turn OFF the computer and unplug the power cord.
2. Remove the battery, wait for 30 second.
3. Re-install the battery.
4. Plug the power cord and turn ON the computer.

### 11) F\_AUDIO (F\_AUDIO Connector)

If you want to use FrontAudio connector, you must remove 5-6, 9-10 Jumper. In order to utilize the front audio header, your chassis must have front audio connector. Also please make sure the pin assignment on the cable is the same as the pin assignment on the MB header. To find out if the chassis you are buying support front audio connector, please contact your dealer. Please note, you can have the alternative of using front audio connector or of using rear audio connector to play sound.

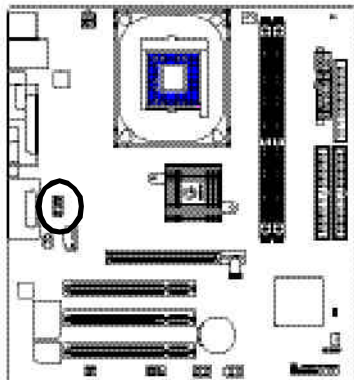

PinNo.	Definition
1	MIC
2	GND
3	REF
4	POWER
5	FrontAudio(R)
6	RearAudio(R)
7	Reserved
8	No Pin
9	FrontAudio(L)
10	RearAudio(L)

12) SUR\_CEN

Please contact your nearest dealer for optional SUR\_CEN cable.

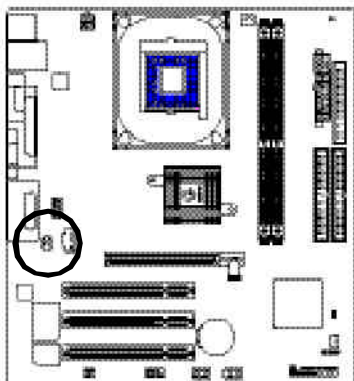

PinNo.	Definition
1	SUROUTL
2	SUROUTR
3	GND
4	No Pin
5	CENTER_OUT
6	BASS_OUT

13) CD\_IN (CD IN, Black)

Connect CD-ROM or DVD-ROM audio out to the connector.

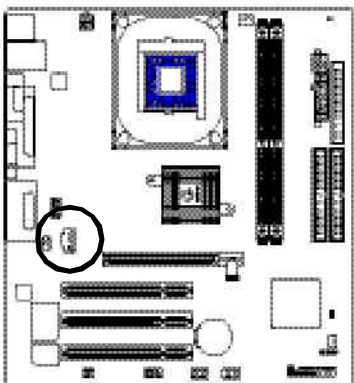

PinNo.	Definition
1	CD-L
2	GND
3	GND
4	CD_R

#### 14) SPDIF\_IO (SPDIF In/Out)

The SPDIF output is capable of providing digital audio to external speakers or compressed AC3 data to an external Dolby Digital Decoder. Use this feature only when your stereo system has digital input function. Use SPDIF IN feature only when your device has digital output function.

Be careful with the polarity of the SPDIF\_IO connector. Check the pin assignment carefully while you connect the SPDIF\_IO cable, incorrect connection between the cable and connector will make the device unable to work or even damage it. For optional SPDIF\_IO cable, please contact your local dealer.

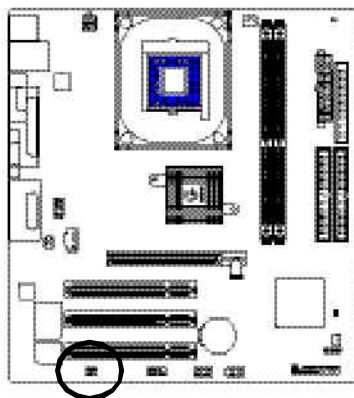

PinNo.	Definition
1	VCC
2	NoPin
3	SPDIF
4	SPDIF I
5	GND
6	GND

#### 15) IR

Make sure the pin 1 on the IR device is along with pin one the connector. To enable the IR function on the board, you are required to purchase an option IR module. Be careful with the polarity of the IR connector. For optional IR cable, please contact your local dealer.

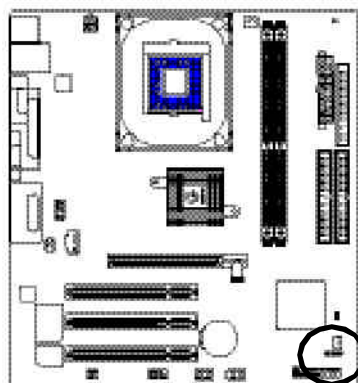

PinNo.	Definition
1	VCC
2	NoPin
3	IR Data Input
4	GND
5	IR Data Output

**16) F\_ USB1 / F\_ USB2 (Front USB Connector, Yellow)**

Be careful with the polarity of the F\_USB connector. Check the pin assignment carefully while you connect the F\_USB cable, incorrect connection between the cable and connector will make the device unable to work or even damage it. For optional F\_USB cable, please contact your local dealer.

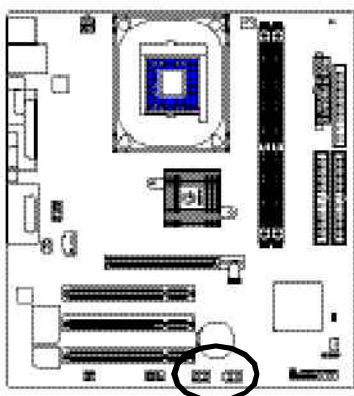

PinNo.	Definition
1	Power
2	Power
3	USB DX-
4	USB Dy-
5	USB DX+
6	USB Dy+
7	GND
8	GND
9	No Pin
10	NC

**17) COMB (COM B Connector)(White)**

Be careful with the polarity of the COMB connector. Check the pin assignment while you connect the COMB cable. Please contact your nearest dealer for optional COMB cable.

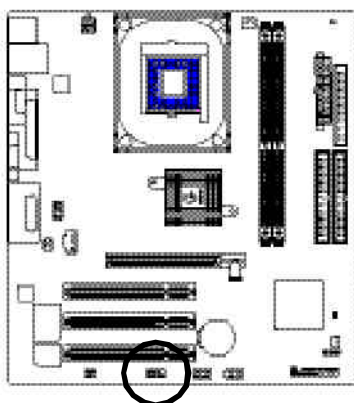

PinNo.	Definition
1	NDCDB-
2	NSINB
3	NSOUTB
4	NDTRB-
5	GND
6	NDSRB-
7	NRTSB-
8	NCTSB-
9	NRIB-
10	No Pin

**18) CI (CASE OPEN)**

This 2 pin connector allows your system to enable or disable the "case open" item in BIOS if the system case begin remove.

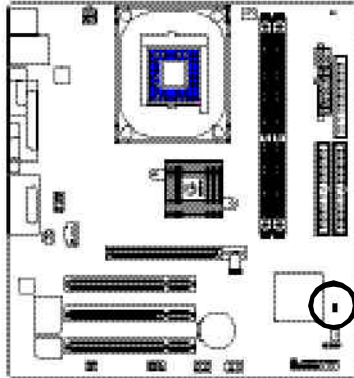



PinNo.	Definition
1	Signal
2	GND

**19) CLR\_CMOS (Clear CMOS)**

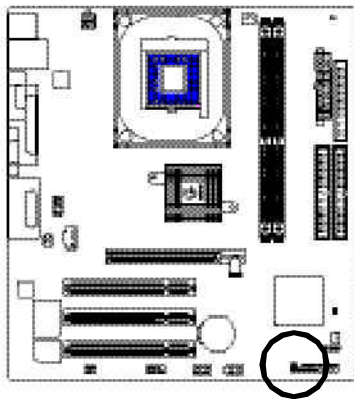
You may clear the CMOS data to its default values by this jumper. To clear CMOS, temporarily shor 1-2 pin. Default doesn't include the "Shunter" to prevent from improper use this jumper.



1  Open: Normal

1  Close: Clear CMOS







## Chapter 3 BIOS Setup

BIOS Setup is an overview of the BIOS Setup Program. The program that allows users to modify the basic system configuration. This type of information is stored in battery-backed CMOS RAM so that it retains the Setup information when the power is turned off.

### ENTERING SETUP

Powering ON the computer and pressing <Del> immediately will allow you to enter Setup. If you require more advanced BIOS settings, please go to "Advanced BIOS" setting menu. To enter Advanced BIOS setting menu, press "Ctrl+F1" key on the BIOS screen.

### CONTROL KEYS

<↑>	Move to previous item
<↓>	Move to next item
<←>	Move to the item in the left hand
<→>	Move to the item in the right hand
Enter	Select item
<Esc>	Main Menu - Quit and not save changes into CMOS Status Page Setup Menu and Option Page Setup Menu - Exit current page and return to Main Menu
<+/PgUp>	Increase the numeric value or make changes
<-/PgDn>	Decrease the numeric value or make changes
<F1>	General help, only for Status Page Setup Menu and Option Page Setup Menu
<F2>	Item Help
<F3>	Reserved
<F4>	Reserved
<F5>	Restore the previous CMOS value from CMOS, only for Option Page Setup Menu
<F6>	Load the file-safe default CMOS value from BIOS default table
<F7>	Load the Optimized Defaults
<F8>	Q-Flash function
<F9>	System Information
<F10>	Save all the CMOS changes, only for Main Menu

## GETTING HELP

### Main Menu

The on-line description of the highlighted setup function is displayed at the bottom of the screen.

### Status Page Setup Menu / Option Page Setup Menu

Press F1 to pop up a small help window that describes the appropriate keys to use and the possible selections for the highlighted item. To exit the Help Window press <Esc>.

## The Main Menu (For example: BIOS Ver. : F1)

Once you enter Award BIOS CMOS Setup Utility, the Main Menu (Figure 1) will appear on the screen. The Main Menu allows you to select from eight setup functions and two exit choices. Use arrow keys to select among the items and press <Enter> to accept or enter the sub-menu.

CMOS Setup Utility - Copyright (C) 1984-2003 Award Software

▶Standard CMOS Features	Top Performance
▶Advanced BIOS Features	Load Fail-Safe Defaults
▶Integrated Peripherals	Load Optimized Defaults
▶Power Management Setup	Set Supervisor Password
▶PnP/PCI Configurations	Set User Password
▶PC Health Status	Save & Exit Setup
▶Frequency/Voltage Control	Exit Without Saving
ESC:Quit	↑↓→←:Select Item
F8: Q-Flash	F10:Save & Exit Setup
Time, Date, Hard Disk Type...	

Figure 1: Main Menu



**If you can't find the setting you want, please press "Ctrl+F1" to search the advanced option widden.**

- **Standard CMOS Features**  
This setup page includes all the items in standard compatible BIOS.
- **Advanced BIOS Features**  
This setup page includes all the items of Award special enhanced features.

- **Integrated Peripherals**  
This setup page includes all onboard peripherals.
- **Power Management Setup**  
This setup page includes all the items of Green function features.
- **PnP/PCI Configurations**  
This setup page includes all the configurations of PCI & PnP ISA resources.
- **PC Health Status**  
This setup page is the System auto detect Temperature, voltage, fan, speed.
- **Frequency/Voltage Control**  
This setup page is control CPU's clock and frequency ratio.
- **Top Performance**  
If you wish to maximize the performance of your system, set "Top Performance" as "Enabled".
- **Load Fail-Safe Defaults**  
Fail-Safe Defaults indicates the value of the system parameters which the system would be in safe configuration.
- **Load Optimized Defaults**  
Optimized Defaults indicates the value of the system parameters which the system would be in best performance configuration.
- **Set Supervisor password**  
Change, set, or disable password. It allows you to limit access to the system and Setup, or just to Setup.
- **Set User password**  
Change, set, or disable password. It allows you to limit access to the system.
- **Save & Exit Setup**  
Save CMOS value settings to CMOS and exit setup.
- **Exit Without Saving**  
Abandon all CMOS value changes and exit setup.

## Standard CMOS Features

CMOS Setup Utility - Copyright (C) 1984-2003 Award Software

### Standard CMOS Features

Date (mm:dd:yy)	Fri, May 3 2002	Item Help
Time (hh:mm:ss)	17:56:23	⏪ ⏩ ⏴ ⏵
▶ IDE Primary Master	None	Change the day, month, year
▶ IDE Primary Slave	None	
▶ IDE Secondary Master	None	<Week>
▶ IDE Secondary Slave	None	Sun. to Sat.
Drive A	1.44M, 3.5 in.	<Month>
Drive B	None	Jan. to Dec.
Floppy 3 Mode Support	Disabled	
Halt On	All, But Keyboard	<Day>
		1 to 31 (or maximum allowed in the month)
Base Memory	640K	
Extended Memory	130048K	<Year>
Total Memory	131072K	1999 to 2098
↑↓→←: Move Enter:Select +/-/PU/PD:Value F10:Save ESC:Exit F1:General Help F5:Previous Values F6:Fail-Safe Defaults F7:Optimized Defaults		

Figure 2: Standard CMOS Features

### Date

The date format is <week>, <month>, <day>, <year>.

- ▶▶ Week The week, from Sun to Sat, determined by the BIOS and is display only
- ▶▶ Month The month, Jan. Through Dec.
- ▶▶ Day The day, from 1 to 31 (or the maximum allowed in the month)
- ▶▶ Year The year, from 1999 through 2098

### Time

The times format in <hour> <minute> <second>. The time is calculated base on the 24-hour military-time clock. For example, 1 p.m. is 13:00:00.

### IDE Primary Master, Slave / IDE Secondary Master, Slave

The category identifies the types of hard disk from drive C to F that has been installed in the computer. There are two types: auto type, and manual type. Manual type is user-definable; Auto type which will automatically detect HDD type.

Note that the specifications of your drive must match with the drive table. The hard disk will not work properly if you enter improper information for this category.

If you select User Type, related information will be asked to enter to the following items. Enter the information directly from the keyboard and press <Enter>. Such information should be provided in the documentation form your hard disk vendor or the system manufacturer.

- ▶▶ CYLS.                    Number of cylinders
- ▶▶ HEADS                    Number of heads
- ▶▶ PRECOMP                Write precomp
- ▶▶ LANDZONE                Landing zone
- ▶▶ SECTORS                Number of sectors

If a hard disk has not been installed select NONE and press <Enter>.

### Drive A/ Drive B

The category identifies the types of floppy disk drive A or drive B that has been installed in the computer.

- ▶▶ None                    No floppy drive installed
- ▶▶ 360K, 5.25 in.            5.25 inch PC-type standard drive; 360K byte capacity .
- ▶▶ 1.2M, 5.25 in.            5.25 inch AT-type high-density drive; 1.2M byte capacity  
(3.5 inch when 3 Mode is Enabled).
- ▶▶ 720K, 3.5 in.            3.5 inch double-sided drive; 720K byte capacity
- ▶▶ 1.44M, 3.5 in.            3.5 inch double-sided drive; 1.44M byte capacity .
- ▶▶ 2.88M, 3.5 in.            3.5 inch double-sided drive; 2.88M byte capacity .

### ❶ Floppy 3 Mode Support (for Japan Area)

- ▶▶ Disabled Normal Floppy Drive. (Default value)
- ▶▶ Drive A Drive A is 3 mode Floppy Drive.
- ▶▶ Drive B Drive B is 3 mode Floppy Drive.
- ▶▶ Both Drive A & B are 3 mode Floppy Drives.

### ❷ Halt on

The category determines whether the computer will stop if an error is detected during power up.

- ▶▶ NO Errors The system boot will not stop for any error that may be detected and you will be prompted.
- ▶▶ All Errors Whenever the BIOS detects a non-fatal error the system will be stopped.
- ▶▶ All, But Keyboard The system boot will not stop for a keyboard error; it will stop for all other errors. (Default value)
- ▶▶ All, But Diskette The system boot will not stop for a disk error; it will stop for all other errors.
- ▶▶ All, But Disk/Key The system boot will not stop for a keyboard or disk error; it will stop for all other errors.

### ❸ Memory

The category is display-only which is determined by POST (PowerOn Self Test) of the BIOS.

#### Base Memory

The POST of the BIOS will determine the amount of base (or conventional) memory installed in the system.

The value of the base memory is typically 512 K for systems with 512 K memory installed on the motherboard, or 640 K for systems with 640 K or more memory installed on the motherboard.

#### Extended Memory

The BIOS determines how much extended memory is present during the POST.

This is the amount of memory located above 1 MB in the CPU's memory address map.



## Advanced BIOS Features

CMOS Setup Utility - Copyright (C) 1984-2003 Award Software

Advanced BIOS Features		
First Boot Device	[Floppy]	Item Help
Second Boot Device	[HDD-0]	↵ → ← →
Third Boot Device	[CDROM]	Select Boot Device
Boot Up Floppy Seek	[Disabled]	priority
Password Check	[Setup]	
		[Floppy] Boot from floppy
		[LS120] Boot from LS120
		[HDD-0] Boot from First HDD
		[HDD-1] Boot from second HDD
↑↓ → ←: Move    Enter: Select    +/-/PU/PD: Value    F10: Save    ESC: Exit    F1: General Help F5: Previous Values    F6: Fail-Safe Defaults    F7: Optimized Defaults		

Figure 3: Advanced BIOS Features

### First / Second / Third Boot Device

- ▶ Floppy                      Select your boot device priority by Floppy .
- ▶ LS120                      Select your boot device priority by LS120.
- ▶ HDD-0~3                  Select your boot device priority by HDD-0~3.
- ▶ SCSI                        Select your boot device priority by SCSI.
- ▶ CDROM                     Select your boot device priority by CDROM.
- ▶ ZIP                         Select your boot device priority by ZIP.
- ▶ USB-FDD                  Select your boot device priority by USB-FDD.
- ▶ USB-ZIP                    Select your boot device priority by USB-ZIP.
- ▶ USB-CDROM                Select your boot device priority by USB-CDROM.
- ▶ USB-HDD                  Select your boot device priority by USB-HDD.

- ▶▶ LAN Select your boot device priority by LAN.
- ▶▶ Disabled Select your boot device priority by Disabled.

#### ▶▶ **Boot Up Floppy Seek**

During POST, BIOS will determine the floppy disk drive installed is 40 or 80 tracks. 360 K type is 40 tracks 720 K, 1.2 M and 1.44 M are all 80 tracks.

- ▶▶ Enabled BIOS searches for floppy disk drive to determine it is 40 or 80 tracks. Note that BIOS can not tell from 720 K, 1.2 M or 1.44 M drive type as they are all 80tracks.
- ▶▶ Disabled BIOS will not search for the type of floppy disk drive by track number. Note that there will not be any warning message if the drive installed is 360 K. (Default value)

#### ▶▶ **Password Check**

- ▶▶ System The system will not boot and will not access to Setup page if the correct password is not entered at the prompt.
- ▶▶ Setup The system will boot but will not access to Setup page if the correct password is not entered at the prompt. (Default value)

## Integrated Peripherals

CMOS Setup Utility - Copyright (C) 1984-2003 Award Software

### Integrated Peripherals

		Item Help
IDE1 Conductor Cable	[Auto]	
IDE2 Conductor Cable	[Auto]	↵ → ← →
On-Chip Primary PCI IDE	[Enabled]	[Auto]
On-Chip Secondary PCI IDE	[Enabled]	Auto-detect IDE
AC97 Audio	[Enabled]	cable type
Onboard LAN Device <sup>(1)</sup>	[Enabled]	
System Share Memory Size	[32MB]	[ATA66/100/133]
USB Controller	[Enabled]	Set Conductor cable
USB Legacy Support	[Disabled]	to ATA66/100/133(80-pins)
Init Display First	[AGP]	
Onboard Serial Port A	[3F8/IRQ4]	[ATA33]
Onboard Serial Port B	[2F8/IRQ3]	Set Conductor cable
Serial Port B Mode	[Normal]	to ATA33(40-pins)
Onboard Parallel Port	[378/IRQ7]	
Parallel Port Mode	[ECP]	
x EPP Mode Select	EPP1.7	
ECP Mode Use DMA	[3]	
Game Port Address	[201]	
Midi Port Address	[330]	
Midi Port IRQ	[10]	
↑↓→←: Move    Enter:Select    +/-/PU/PD:Value    F10:Save    ESC:Exit    F1:General Help F5:Previous Values    F6:Fail-Safe Defaults    F7:Optimized Defaults		

Figure 4: Integrated Peripherals

#### IDE1 Conductor Cable

- ▶▶ Auto Will be automatically detected by BIOS. (Default Value)
- ▶▶ ATA66/100/133 Set IDE1 Conductor Cable to ATA66/100/133 (Please make sure your IDE device and cable is compatible with ATA66/100/133).
- ▶▶ ATA33 Set IDE1 Conductor Cable to ATA33 (Please make sure your IDE device and cable is compatible with ATA33).

<sup>1</sup> For GA-8S650GXM-P only.

### ☛ IDE2 Conductor Cable

- ☛ Auto Will be automatically detected by BIOS. (Default Value)
- ☛ ATA66/100/133 Set IDE2 Conductor Cable to ATA66/100/133 (Please make sure your IDE device and cable is compatible with ATA66/100/133).
- ☛ ATA33 Set IDE2 Conductor Cable to ATA33 (Please make sure your IDE device and cable is compatible with ATA33).

### ☛ On-Chip Primary PCI IDE

- ☛ Enabled Enable onboard 1st channel IDE port. (Default value)
- ☛ Disabled Disable onboard 1st channel IDE port.

### ☛ On-Chip Secondary PCI IDE

- ☛ Enabled Enable onboard 2nd channel IDE port. (Default value)
- ☛ Disabled Disable onboard 2nd channel IDE port.

### ☛ AC97 Audio

- ☛ Enabled Enable onboard AC'97 audio function. (Default value)
- ☛ Disabled Disable this function.

### ☛ Onboard LAN Device <sup>④</sup>

- ☛ Enabled Enable onboard LAN device. (Default value)
- ☛ Disabled Disable onboard LAN device.

### ☛ System Share Memory Size

- ☛ 4MB/8MB/16MB/32MB/64MB Set onchip VGA shared memory size.(Default Value:32MB)

### ☛ USB Controller

- ☛ Enabled Enable USB Controller. (Default value)
- ☛ Disabled Disable USB Controller.

### ☛ USB Legacy Support

- ☛ Enabled Enable USB Legacy Support.
- ☛ Disabled Disable USB Legacy Support. (Default value)

④ For GA-8S650GXM-P only.

**Init Display First**

- ▶▶ AGP Set Init Display First to AGP. (Default value)
- ▶▶ PCI Set Init Display First to PCI.

**Onboard Serial Port A**

- ▶▶ Auto BIOS will automatically setup the port A address.
- ▶▶ 3F8/IRQ4 Enable onboard Serial port A and address is 3F8. (Default value)
- ▶▶ 2F8/IRQ3 Enable onboard Serial port A and address is 2F8.
- ▶▶ 3E8/IRQ4 Enable onboard Serial port A and address is 3E8.
- ▶▶ 2E8/IRQ3 Enable onboard Serial port A and address is 2E8.
- ▶▶ Disabled Disable onboard Serial port A.

**Onboard Serial Port B**

- ▶▶ Auto BIOS will automatically setup the port B address.
- ▶▶ 3F8/IRQ4 Enable onboard Serial port B and address is 3F8.
- ▶▶ 2F8/IRQ3 Enable onboard Serial port B and address is 2F8. (Default value)
- ▶▶ 3E8/IRQ4 Enable onboard Serial port B and address is 3E8.
- ▶▶ 2E8/IRQ3 Enable onboard Serial port B and address is 2E8.
- ▶▶ Disabled Disable onboard Serial port B.

**Serial Port B Mode**

(This item allows you to determine which Infra Red(IR) function of Onboard I/O chip)

- ▶▶ ASKIR Set onboard I/O chip UART to ASKIR Mode.
- ▶▶ IrDA Set onboard I/O chip UART to IrDA Mode.
- ▶▶ Normal Set onboard I/O chip UART to Normal Mode. (Default Value)

**Onboard Parallel port**

- ▶▶ 378/IRQ7 Enable onboard LPT port and address is 378/IRQ7. (Default Value)
- ▶▶ 278/IRQ5 Enable onboard LPT port and address is 278/IRQ5.
- ▶▶ Disabled Disable onboard LPT port.
- ▶▶ 3BC/IRQ7 Enable onboard LPT port and address is 3BC/IRQ7.

**Parallel Port Mode**

- ▶▶ SPP Using Parallel port as Standard Parallel Port.
- ▶▶ EPP Using Parallel port as Enhanced Parallel Port.
- ▶▶ ECP Using Parallel port as Extended Capabilities Port. (Default Value)
- ▶▶ ECP+EPP Using Parallel port as ECP & EPP mode.

**EPP Mode Select**

- ▶▶ EPP 1.9 Compliant with EPP 1.9 version.
- ▶▶ EPP 1.7 Compliant with EPP 1.7 version.(Default Value)

**ECP Mode Use DMA**

- ▶▶ 3 Set ECP Mode Use DMA to 3. (Default Value)
- ▶▶ 1 Set ECP Mode Use DMA to 1.

**Game Port Address**

- ▶▶ 201 Set Game Port Address to 201. (Default Value)
- ▶▶ 209 Set Game Port Address to 209.
- ▶▶ Disabled Disable this function.

**Midi Port Address**

- ▶▶ 290 Set Midi Port Address to 290.
- ▶▶ 300 Set Midi Port Address to 300.
- ▶▶ 330 Set Midi Port Address to 330.(Default Value)
- ▶▶ Disabled Disable this function.

**Midi Port IRQ**

- ▶▶ 5 Set Midi Port IRQ to 5.
- ▶▶ 10 Set Midi Port IRQ to 10. (Default Value)

## Power Management Setup

CMOS Setup Utility - Copyright (C) 1984-200 Award Software

Power Management Setup		
ACPI Suspend Type	[S1(POS)]	Item Help
Soft-Off by PWR_BTTN	[Off]	⤵⤴⤶⤷⤸⤹
System After AC Back	[Off]	[S1]
IRQ [3-7, 9-15], NMI	[Enabled]	Set suspend type to
ModemRingOn	[Enabled]	Power On Suspend under
PME Event Wake Up	[Enabled]	ACPI OS
Power On by Keyboard	[Disabled]	
Power On by Mouse	[Disabled]	[S3]
Resume by Alarm	[Disabled]	Set suspend type to
x Month Alarm	NA	Suspend to RAM under
x Day (of Month)	0	ACPI OS
x Time (hh:mm:ss)	0 0 0	
Power LED in S1 state	[Blinking]	
↑↓→←: Move Enter:Select +/-/PU/PD:Value F10:Save ESC:Exit F1:General Help F5:Previous Values F6:Fail-Safe Defaults F7:Optimized Defaults		

Figure 5: Power Management Setup

### ACPI Suspend Type

- ▶▶ S1(POS) Set ACPI suspend type to S1. (Default Value)
- ▶▶ S3(STR) Set ACPI suspend type to S3.

### Soft-off by PWR\_BTTN

- ▶▶ Off The user press the power button once, he can turn off the system. (Default Value)
- ▶▶ Suspend The user press the power button once, then the system will can enter suspend mode.

### System after AC Back

- ▶▶ LastState When AC-power back to the system, the system will return to the Last state before AC-power off.
- ▶▶ Off When AC-power back to the system, the system will be in "Off" state. (Default Value)
- ▶▶ On When AC-power back to the system, the system will be in "On" state.

☞ **IRQ [3-7, 9-15], NMI**

- ☞ Disabled            Disable this function.
- ☞ Enabled            Enable this function. (Default value)

☞ **ModemRingOn**

- ☞ Disabled            Disable Modem Ring on function.
- ☞ Enabled            Enable Modem Ring on function. (Default Value)

☞ **PME Event Wake Up**

- ☞ Disabled            Disable this function.
- ☞ Enabled            Enable PME Event Wake up. (Default Value)

☞ **Power On by Keyboard**

- ☞ Password            Input password (from 1 to 8 characters) and press Enter to set the Keyboard Power On Password.
- ☞ Any Key            Set Keyboard power on by any key.
- ☞ Disabled            Disable this function. (Default Value)

☞ **Power On by Mouse**

- ☞ Enabled            Enable Power On by Mouse function.
- ☞ Disabled            Disable this function. (Default Value)

☞ **Resume by Alarm**

You can set "Resume by Alarm" item to enabled and key in Data/time to power on system.

- ☞ Disabled            Disable this function. (Default Value)
- ☞ Enabled            Enable alarm function to POWER ON system.

If RTC Alarm Lead To Power On is Enabled.

Month Alarm :                    NA, 1~12

Day (of Month) :                1~31

Time ( hh: mm: ss) :            (0~23) : (0~59) : (0~59)

☞ **Power LED in S1 state**

- ☞ Blinking            In standby mode(S1), power LED will blink. (Default Value)
- ☞ Dual/OFF            In standby mode(S1):
  - a. If use single color LED, power LED will turn off.
  - b. If use dual color LED, power LED will turn to another color.



## PnP/PCI Configurations

CMOS Setup Utility - Copyright (C) 1984-2003 Award Software

PnP/PCI Configurations		Item Help
PCI 1 IRQ Assignment	[Auto]	
PCI 2 IRQ Assignment	[Auto]	↶ ↷ ↸ ↹ ↺ ↻
PCI 3 IRQ Assignment	[Auto]	
↑↓→←: Move    Enter:Select    +/-/PU/PD:Value    F10:Save    ESC:Exit    F1:General Help F5:Previous Values    F6:Fail-Safe Defaults    F7:Optimized Defaults		

Figure 6: PnP/PCI Configurations

### ❶ PCI 1 IRQ Assignment

- ▶▶ Auto                      Auto assign IRQ to PCI 1. (Default value)
- ▶▶ 3,4,5,7,9,10,11,12,14,15    Set IRQ 3,4,5,7,9,10,11,12,14,15 to PCI 1.

### ❷ PCI 2 IRQ Assignment

- ▶▶ Auto                      Auto assign IRQ to PCI 2. (Default value)
- ▶▶ 3,4,5,7,9,10,11,12,14,15    Set IRQ 3,4,5,7,9,10,11,12,14,15 to PCI 2.

### ❸ PCI 3 IRQ Assignment

- ▶▶ Auto                      Auto assign IRQ to PCI 3. (Default value)
- ▶▶ 3,4,5,7,9,10,11,12,14,15    Set IRQ 3,4,5,7,9,10,11,12,14,15 to PCI 3.

## PC Health Status

CMOS Setup Utility-Copyright (C) 1984-2003 Award Software

### PC Health Status

Reset Case Open Status	[Disabled]	Item Help
Case Opened	No	↶→↷↸↹↺
<b>VCORE</b>	<b>1.71V</b>	
<b>+3.3V</b>	<b>3.29V</b>	
<b>+5V</b>	<b>4.99V</b>	
<b>+12V</b>	<b>11.73V</b>	
<b>Current System Temperature</b>	<b>33°C/ 91°F</b>	
<b>Current CPU Temperature</b>	<b>27°C/ 80°F</b>	
<b>Current CPU FAN Speed</b>	<b>4821 RPM</b>	
<b>Current SYSTEM FAN Speed</b>	<b>0 RPM</b>	
CPU Warning Temperature	[Disabled]	
CPU FAN Fail Warning	[Disabled]	
SYSTEM FAN Fail Warning	[Disabled]	
↑↓→←: Move Enter:Select +/-/PU/PD:Value F10:Save ESC:Exit F1:General Help F5:Previous Values F6:Fail-Safe Defaults F7:Optimized Defaults		

Figure 7: PC Health Status

#### ☛ **Reset Case Open Status**

##### ☛ **Case Opened**

If the case is closed, "Case Opened" will show "No".

If the case have been opened, "Case Opened" will show "Yes".

If you want to reset "Case Opened" value, set "Reset Case Open Status" to "Enabled" and save CMOS, your computer will restart.

#### ☛ **Current Voltage (V) VCORE / +3.3V / +5V / +12V**

▶▶ Detect system's voltage status automatically.

#### ☛ **Current System/CPU Temperature**

▶▶ Detect System/CPU Temp. automatically.

#### ☛ **Current CPU/SYSTEM FAN Speed (RPM)**

▶▶ Detect CPU/SYSTEM Fan speed status automatically.

**☛ CPU Warning Temperature**

- ▶▶ 60°C / 140°F Monitor CPU Temp. at 60°C / 140°F.
- ▶▶ 70°C / 158°F Monitor CPU Temp. at 70°C / 158°F.
- ▶▶ 80°C / 176°F Monitor CPU Temp. at 80°C / 176°F.
- ▶▶ 90°C / 194°F Monitor CPU Temp. at 90°C / 194°F.
- ▶▶ Disabled Disable this function.(Default value)

**☛ CPU FAN Fail Warning**

- ▶▶ Disabled Fan Warning Function Disable. (Default value)
- ▶▶ Enabled Fan Warning Function Enable.

**☛ SYSTEM FAN Fail Warning**

- ▶▶ Disabled Fan Warning Function Disable. (Default value)
- ▶▶ Enabled Fan Warning Function Enable.

## Frequency/Voltage Control

CMOS Setup Utility-Copyright (C) 1984-2003 Award Software

### Frequency/Voltage Control

CPU Clock Ratio	[10X]	Item Help
Linear Frequency Control	[Disabled]	←→↔↔↔
x CPU Clock (MHz)	100	
x DRAM Clock (MHz)	AUTO	
x AGP Clock (MHz)	AUTO	
x PCI Clock (MHz)	AUTO	
↑↓→←: Move    Enter:Select    +/-/PU/PD:Value    F10:Save    ESC:Exit    F1:General Help F5:Previous Values    F6:Fail-Safe Defaults    F7:Optimized Defaults		

Figure 8: Frequency/Voltage Control

#### ☛ CPU Clock Ratio

This setup option will automatically assign by CPU detection.

**For Willamette CPU:**

8X~23X default: 14X

**For C-Stepping P4:**

8X,10X~24X default: 15X

**For Northwood CPU:**

12X~24X default: 16X

The option will display "Locked" and read only if the CPU ratio is not changeable.

#### ☛ Linear Frequency Control

▶ Disabled            Disable this function. (Default value)

▶ Enabled            Enable this function.

#### ☛ CPU Clock

▶ 100~355            Select CPU Clock to 100MHz~355MHz.

Incorrect using it may cause your system broken. For power End-User use only!

**▶▶ DRAM Clock (MHz)**

▶▶ Please set DRAM Clock according to your requirement.

If you use DDR200 DRAM module, please set "DRAM Clock(MHz)" to 200. If you use DDR333 DRAM module, please set "DRAM Clock(MHz)" to 333.

Incorrect using it may cause your system broken. For power End-User use only!

**▶▶ AGP Clock (MHz)**

▶▶ Please set AGP Clock according to your requirement.

Incorrect using it may cause your system broken. For power End-User use only!

**▶▶ PCI Clock (MHz)**

▶▶ Please set PCI Clock according to your requirement.

Incorrect using it may cause your system broken. For power End-User use only!

## Top Performance

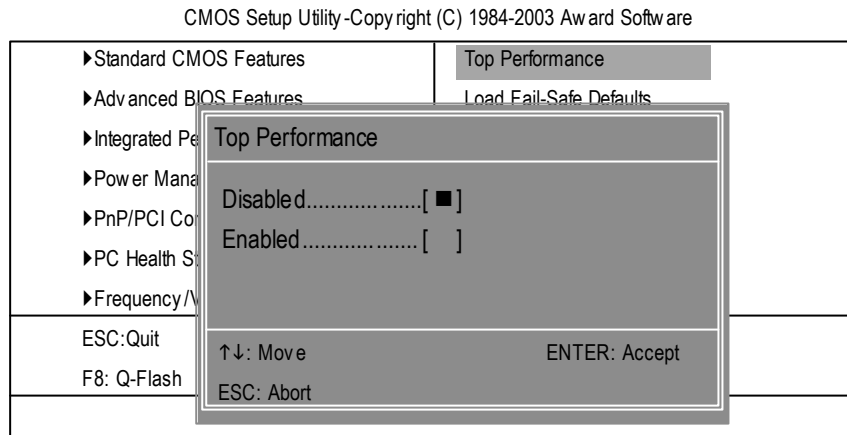

Figure 9: Top Performance

### Top Performance

If you wish to maximize the performance of your system, set "Top Performance" as "Enabled".

- ▶ Disabled    Disable this function. (Default Value)
- ▶ Enabled    Enable Top Performance function.



**You must check whether your RAM, CPU support over clock when you set "Top Performance" to "Enabled".**

## Load Fail-Safe Defaults

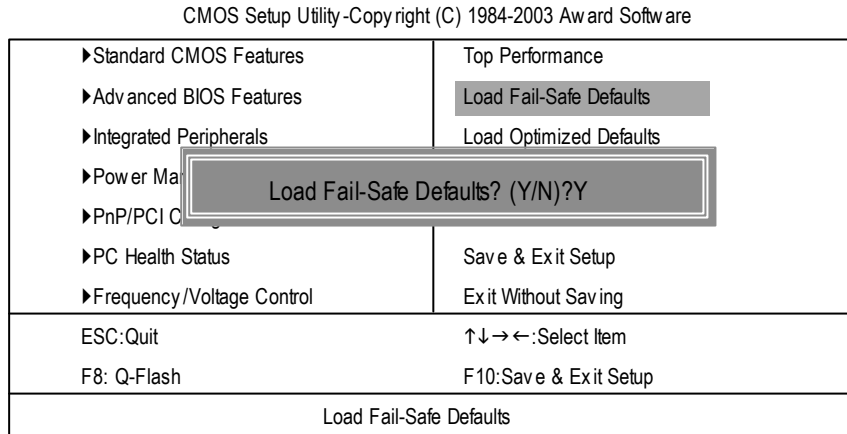

Figure 10: Load Fail-Safe Defaults

### Load Fail-Safe Defaults

Fail-Safe defaults contain the most appropriate values of the system parameters that allow minimum system performance.

## Load Optimized Defaults

CMOS Setup Utility - Copy right (C) 1984-2003 Award Software

▶Standard CMOS Features	Top Performance
▶Advanced BIOS Features	Load Fail-Safe Defaults
▶Integrated Peripherals	Load Optimized Defaults
▶Power M	Load Optimized Defaults? (Y/N)?Y
▶PnP/PCI	Save & Exit Setup
▶PC Health Status	Exit Without Saving
▶Frequency/Voltage Control	
ESC:Quit	↑↓→←:Select Item
F8: Q-Flash	F10:Save & Exit Setup
Load Optimized Defaults	

Figure 11: Load Optimized Defaults

### Load Optimized Defaults

Selecting this field loads the factory defaults for BIOS and Chipset Features which the system automatically detects.



## Set Supervisor/User Password

CMOS Setup Utility - Copy right (C) 1984-2003 Award Software

▶Standard CMOS Features	Top Performance
▶Advanced BIOS Features	Load Fail-Safe Defaults
▶Integrated Peripherals	Load Optimized Defaults
▶Power Management	
▶PnP/PCI Configurations	
▶PC Health Status	Save & Exit Setup
▶Frequency/Voltage Control	Exit Without Saving
Enter Password:	
ESC: Quit	↑↓→←: Select Item
F8: Q-Flash	F10: Save & Exit Setup
Change/Set/Disable Password	

Figure 12: Password Setting

When you select this function, the following message will appear at the center of the screen to assist you in creating a password.

Type the password, up to eight characters, and press <Enter>. You will be asked to confirm the password. Type the password again and press <Enter>. You may also press <Esc> to abort the selection and not enter a password.

To disable password, just press <Enter> when you are prompted to enter password. A message "PASSWORD DISABLED" will appear to confirm the password being disabled. Once the password is disabled, the system will boot and you can enter Setup freely.

The BIOS Setup program allows you to specify two separate passwords:

SUPERVISOR PASSWORD and a USER PASSWORD. When disabled, anyone may access all BIOS Setup program function. When enabled, the Supervisor password is required for entering the BIOS Setup program and having full configuration fields, the User password is required to access only basic items.

If you select "System" at "Password Check" in Advance BIOS Features Menu, you will be prompted for the password every time the system is rebooted or any time you try to enter Setup Menu.

If you select "Setup" at "Password Check" in Advance BIOS Features Menu, you will be prompted only when you try to enter Setup.

### Save & Exit Setup

CMOS Setup Utility - Copyright (C) 1984-2003 Award Software

▶ Standard CMOS Features	Top Performance
▶ Advanced BIOS Features	Load Fail-Safe Defaults
▶ Integrated Peripherals	Load Optimized Defaults
▶ Power Management Setup	Set Supervisor Password
▶ PnP/PCI Configurations	
▶ PC Health Status	
▶ Frequency/Voltage Control	Exit Without Saving
ESC: Quit	↑↓→←: Select Item
F8: Q-Flash	F10: Save & Exit Setup
Save Data to CMOS	

Figure 13: Save & Exit Setup

Type "Y" will quit the Setup Utility and save the user setup value to RTC CMOS.  
Type "N" will return to Setup Utility.

## Exit Without Saving

CMOS Setup Utility - Copyright (C) 1984-2003 Award Software

▶ Standard CMOS Features	Top Performance
▶ Advanced BIOS Features	Load Fail-Safe Defaults
▶ Integrated Peripherals	Load Optimized Defaults
▶ Power Management Setup	Set Supervisor Password
▶ PnP/PCI Co	Quit Without Saving (Y/N)? N
▶ PC Health S	Exit Without Saving
▶ Frequency/Voltage Control	
ESC: Quit	↑↓→←: Select Item
F8: Q-Flash	F10: Save & Exit Setup
Abandon all Data	

Figure 14: Exit Without Saving

Type "Y" will quit the Setup Utility without saving to RTC CMOS.

Type "N" will return to Setup Utility.



## Chapter 4 Technical Reference

### @ BIOS™ Introduction

#### Gigabyte announces @ BIOS Windows BIOS live update utility



Have you ever updated BIOS by yourself? Or like many other people, you just know what BIOS is, but always hesitate to update it? Because you think updating newest BIOS is unnecessary and actually you don't know how to update it.

Maybe not like others, you are very experienced in BIOS updating and spend quite a lot of time to do it. But of course you don't like to do it too much. First, download different BIOS from website and then switch the operating system to DOS mode. Secondly, use different flash utility to update BIOS. The above process is not a interesting job. Besides, always be carefully to store the BIOS source code correctly in your disks as if you update the wrong BIOS, it will be a nightmare.

Certainly, you wonder why motherboard vendors could not just do something right to save your time and effort and save you from the lousy BIOS updating work? Here it comes! Now Gigabyte announces @BIOS—the first Windows BIOS live update utility. This is a smart BIOS update software. It could help you to download the BIOS from internet and update it. Not like the other BIOS update software, it's a Windows utility. With the help of "@BIOS", BIOS updating is no more than a click.

Besides, no matter which mainboard you are using, if it's a Gigabyte's product\*, @BIOS help you to maintain the BIOS. This utility could detect your correct mainboard model and help you to choose the BIOS accordingly. It then downloads the BIOS from the nearest Gigabyte ftp site automatically. There are several different choices; you could use "Internet Update" to download and update your BIOS directly. Or you may want to keep a backup for your current BIOS, just choose "Save Current BIOS" to save it first. You make a wise choice to use Gigabyte, and @BIOS update your BIOS smartly. You are now worry free from updating wrong BIOS, and capable to maintain and manage your BIOS easily. Again, Gigabyte's innovative product erects a milestone in mainboard industries.

For such a wonderful software, how much it costs? Impossible! It's free! Now, if you buy a Gigabyte's motherboard, you could find this amazing software in the attached driver CD. But please remember, connected to internet at first, then you could have a internet BIOS update from your Gigabyte @BIOS.

## Easy Tune™ 4 Introduction

### Gigabyte announces *EasyTune™ 4*

#### Windows based Overclocking utility

EasyTune 4 carries on the heritage so as to pave the way for future generations.



"Overclock" might be one of the most common issues in computer field. But have many users ever tried it? The answer is probably "no". Because "Overclock" is thought to be very difficult and includes a lot of technical know-how, sometimes "Overclock" is even considered as special skills found only in some enthusiasts. But as to the experts in "Overclock", what's the truth? They may spend quite a lot of time and money to study, try and use many different hard-

ware or BIOS tools to do "Overclock". And even with these technologies, they still learn that it's quite a risk because the safety and stability of an "Overclock" system is unknown. Now everything is different because of a Windows based overclocking utility "EasyTune 4" --announced by Gigabyte. This windows based utility has totally changed the gaming rule of "Overclock". This is the first windows based overclocking utility is suitable for both normal and power users. Users can choose either "Easy Mode" or "Advanced Mode" for overclocking at their convenience. For users who choose "Easy Mode", they just need to click "Auto Optimize" to have autoed and immediate CPU overclocking. This software will then overdrive CPU speed automatically with the result being shown in the control panel. If users prefer "Overclock" by them, there is also another choice. Click "Advanced Mode" to enjoy "sport drive" class Overclocking user interface. "Advanced Mode", allows users to change the system bus / AGP / Memory working frequency in small increments to get ultimate system performance. It operates in coordination with Gigabyte motherboards. Besides, it is different from other traditional over-clocking methods, EasyTune 4 doesn't require users to change neither BIOS nor hardware switch/jumper setting; on the other hand, they can do "Overclock" at easy step. Therefore, this is a safer way for "Overclock" as nothing is changed on software or hardware. If user runs EasyTune 4 over system's limitation, the biggest loss is only to restart the computer again and the side effect is then well controlled. Moreover, if one well-performed system speed has been tested in EasyTune 4, user can "Save" this setting and "Load" it in next time. Obviously, Gigabyte EasyTune 4 has already turned the "Overclock" technology toward to a newer generation. This wonderful software is now free bundled in Gigabyte motherboard attached in driver CD. Users may make a test drive of "EasyTune 4" to find out more amazing features by themselves.

\*Some Gigabyte products are not fully supported by EasyTune 4. Please find the products supported list in the web site.

\*Any "Overclocking action" is at user's risk, Gigabyte Technology will not be responsible for any damage or instability to your processor, motherboard, or any other components.

## Flash BIOS Method Introduction

Method 1 : Q-Flash



### Flash BIOS Method Introduction

Q-Flash™ is a BIOS flash utility embedded in Flash ROM. With this utility, users only have to stay in the BIOS menu when they want to update BIOS. Q-Flash™ allows users to flash BIOS without any utility in DOS or Windows. Using Q-Flash™ indicating no more fooling around with any complicated instructions and operating system since it is in the BIOS menu.



Please note that because updating BIOS has potential risk, please do it with caution!! We are sorry that Gigabyte Technology Co., Ltd is not responsible for damages of system because of incorrect manipulation of updating BIOS to avoid any claims from end-users.

### Before You Begin:

Before you start updating BIOS with the Q-Flash™ utility, please follow the steps below first.

1. Download the latest BIOS for your motherboard from Gigabyte's website.
2. Extract the BIOS file downloaded and save the BIOS file (the one with model name.Fxx. For example, 7VRXP.F12) to a floppy disk.
3. Reboot your PC and press **Del** to enter BIOS menu.

The BIOS upgrading guides below are separated into two parts.

If your motherboard has dual BIOS, please refer to Part One.

If your motherboard has single BIOS, please refer to Part Two.

**Part One:  
Updating BIOS with Q-Flash™ Utility on Dual BIOS Motherboards.**

Some of Gigabyte motherboards are equipped with dual BIOS. In the BIOS menu of the motherboards supporting Q-Flash™ and Dual BIOS, the Q-Flash™ utility and Dual BIOS utility are combined in the same screen. This section only deals with how to use Q-Flash™ utility. In the following sections, we take GA-7VRXP as the example to guide you how to flash BIOS from an older version to the latest version. For example, from F10 to F12.



**Entering the Q-Flash™ utility:**

Step1: To use Q-Flash™ utility, you must press **Del** in the bootscreen to enter BIOS menu.

AMBIOS SIMPLE SETUP UTILITY - VERSION 2.00 (C) 2001 American Megatrends, Inc. All Rights Reserved	
STANDARD CMOS SETUP	INTEGRATED PERIPHERALS
BIOS FEATURES SETUP	HARDWARE MONITOR & MISC SETUP
CHIPSET FEATURES SETUP	SUPERVISOR PASSWORD
POWER MANAGEMENT SETUP	USER PASSWORD
PNP / PCI CONFIGURATION	IDE HDD AUTO DETECTION
LOAD FAIL-SAFE DEFAULTS	SAVE & EXIT SETUP
LOAD OPTIMIZED DEFAULTS	EXIT WITHOUT SAVING
ESC: Quit      ↑↓←→: Select Item      F5: Old Values    F6: Fail-Safe Values	
F7: Optimized Values	F8: Dual BIOS/Q-Flash
F10: Save & Exit	
Load Fail-Safe Defaults	



Step 2: Press **F8** button on your keyboard and then **Y** button to enter the Q-Flash™ utility.

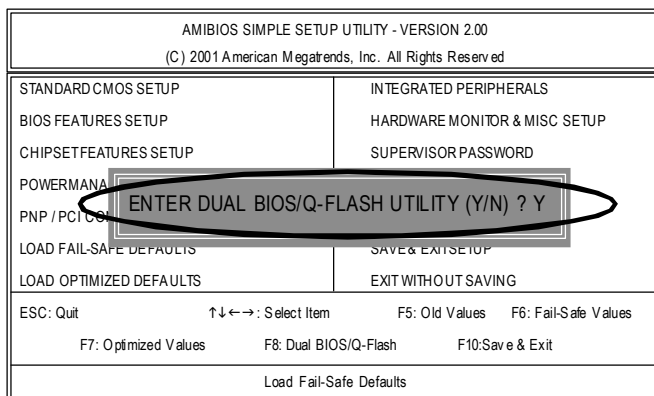

### Exploring the Q-Flash™/Dual BIOS utility screen

The Q-Flash™/Dual BIOS utility screen consists of the following key components.

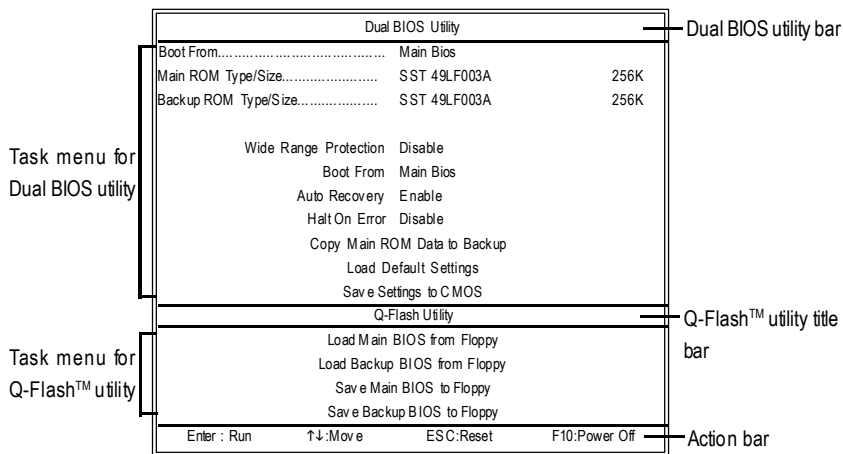

**Task menu for Dual BIOS utility:**

Contains the names of eight tasks and two items showing information about the BIOS ROM type. Blocking a task and pressing **Enter** key on your keyboard to enable execution of the task.

**Task menu for Q-Flash™ utility:**

Contains the names of four tasks. Blocking a task and pressing **Enter** key on your keyboard to enable execution of the task.

**Action bar:**

Contains the names of four actions needed to operate the Q-Flash™/Dual BIOS utility. Pressing the buttons mentioned on your keyboards to perform these actions.

**Using the Q-Flash™ utility:**

This section tells you how to update BIOS using the Q-Flash™ utility. As described in the "Before you begin" section above, you must prepare a floppy disk having the BIOS file for your motherboard and insert it to your computer. If you have already put the floppy disk into your system and have entered the Q-Flash™ utility, please follow the steps below to flash BIOS.

**Steps:**

1. Press arrow buttons on your keyboard to move the light bar to "Load Main BIOS from Floppy" item in the Q-Flash™ menu and press **Enter** button.



If you want to save the current BIOS for backup purpose, you can begin Step 1 with "Save Main BIOS to Floppy" item.

Dual BIOS Utility			
Boot From.....	Main Bios		
Main ROM Type/Size.....	SST 49LF003A	256K	
Backup ROM Type/Size.....	SST 49LF003A	256K	
Wide Range Protection Disable			
Boot From Main Bios			
Auto Recovery Enable			
Halt On Error Disable			
Copy Main ROM Data to Backup			
Load Default Settings			
Save Settings to CMOS			
Q-Flash Utility			
Load Main BIOS from Floppy			
Load Backup BIOS from Floppy			
Save Main BIOS to Floppy			
Save Backup BIOS to Floppy			
Enter : Run	↑↓:Move	ESC:Reset	F10:Power Off

Later, you will see a box pop up showing the BIOS files you previously downloaded to the floppy disk.

2. Move to the BIOS file you want to flash and press Enter.

In this example, we only download one BIOS file to the floppy disk so only one BIOS file, 7VRXP.F12, is listed.



Please confirm again you have the correct BIOS file for your motherboard.

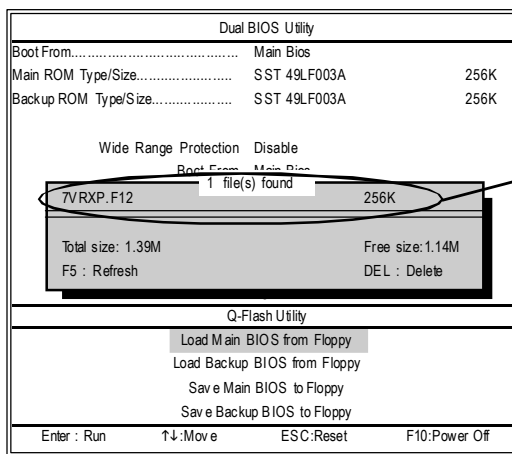

BIOS file in the floppy disk.

After pressing **Enter**, you'll then see the progress of reading the BIOS file from the floppy disk.

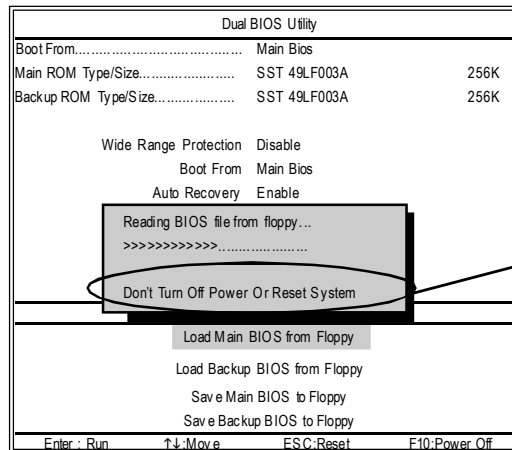

Do not turning off power or reset your system at this stage!!



Please do not take out the floppy disk when it begins flashing BIOS.

After BIOS file is read, you'll see a confirmation dialog box asking you "Are you sure to update BIOS?"

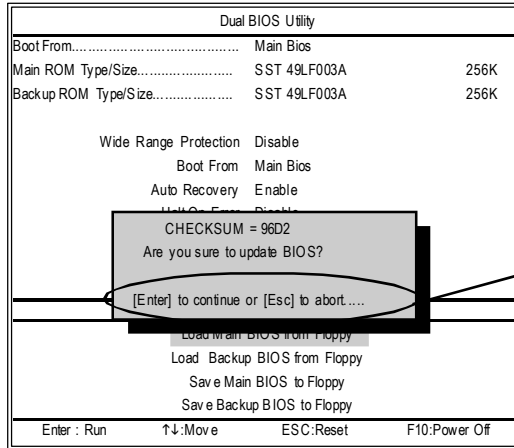

You can press "Enter" to continue updating BIOS or "ESC" to abort.

3. Press Y button on your keyboard after you are sure to update BIOS. Then it will begin to update BIOS. The progress of updating BIOS will be displayed.

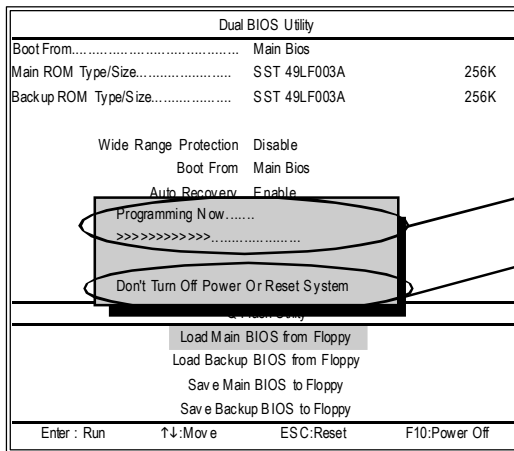

The progress of updating BIOS.





Do not turning off power or reset your system at this stage to avoid damaging your BIOS rom!!

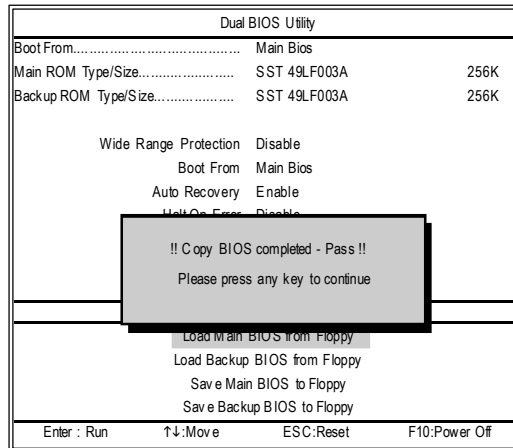

Please do not take out the floppy disk when it begins flashing BIOS.

4. Press any keys to return to the Q-Flash™ menu when the BIOS updating procedure is completed.



 You can repeat Step 1 to 4 to flash the backup BIOS, too.

5. Press **Esc** and then **Y** button to exit the Q-Flash™ utility. The computer will restart automatically after you exit Q-Flash™.

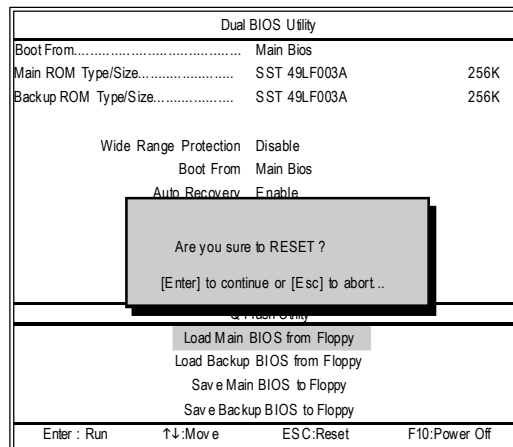

After system reboots, you may find the BIOS version on your bootscreen becomes the one you flashed.

The BIOS file becomes F12 after updating



 The following is an AMI BIOS menu screen. However, you can also find similar option in AWARD BIOS menu.

6. Press **Del** to enter BIOS menu after system reboots. When you are in BIOS menu, move to **Load Fail-Safe Defaults** item and press **Enter** to load BIOS Fail-Safe Defaults. Normally the system redetects all devices after BIOS has been upgraded. Therefore, we highly recommend reloading the BIOS defaults after BIOS has been upgraded.

Press Enter on your keyboard

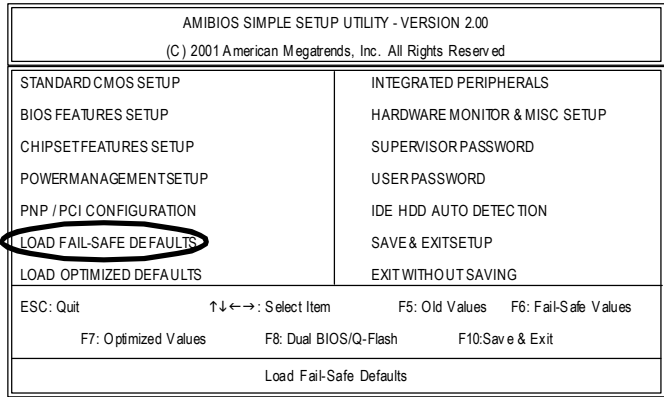

Press Y on your keyboard to load defaults.

AMIBIOS SIMPLE SETUP UTILITY - VERSION 2.00 (C) 2001 American Megatrends, Inc. All Rights Reserved	
STANDARD CMOS SETUP	INTEGRATED PERIPHERALS
BIOS FEATURES SETUP	HARDWARE MONITOR & MISC SETUP
CHIPSET FEATURES SETUP	SUPERVISOR PASSWORD
POWERMANAGE	<b>Load Fail-Safe Defaults (Y/N)? Y</b>
PNP / PCI CONF	LOAD FAIL-SAFE DEFAULTS
LOAD FAIL-SAFE DEFAULTS	SAVE & EXIT SETUP
LOAD OPTIMIZED DEFAULTS	EXIT WITHOUT SAVING
ESC: Quit                      ↑↓←→: Select Item                      F5: Old Values                      F6: Fail-Safe Values F7: Optimized Values                      F8: Dual BIOS/Q-Flash                      F10: Save & Exit	
Load Fail-Safe Defaults	

7. Select **Save & Exit Setup** item to save the settings to CMOS and exit the BIOS menu. System will reboot after you exit the BIOS menu. The procedure is completed.

Press Y on your keyboard to save and exit.

AMIBIOS SIMPLE SETUP UTILITY - VERSION 2.00 (C) 2001 American Megatrends, Inc. All Rights Reserved	
STANDARD CMOS SETUP	INTEGRATED PERIPHERALS
BIOS FEATURES SETUP	HARDWARE MONITOR & MISC SETUP
CHIPSET FEATURES SETUP	SUPERVISOR PASSWORD
POWERMANAGE	<b>SAVE to CMOS and EXIT (Y/N) ? Y</b>
PNP / PCI CONF	LOAD FAIL-SAFE DEFAULTS
LOAD FAIL-SAFE DEFAULTS	SAVE & EXIT SETUP
LOAD OPTIMIZED DEFAULTS	EXIT WITHOUT SAVING
ESC: Quit                      ↑↓←→: Select Item                      F5: Old Values                      F6: Fail-Safe Values F7: Optimized Values                      F8: Dual BIOS/Q-Flash                      F10: Save & Exit	
Load Fail-Safe Defaults	





### Exploring the Q-Flash™ utility screen

The Q-Flash™ BIOS utility screen consists of the following key components.

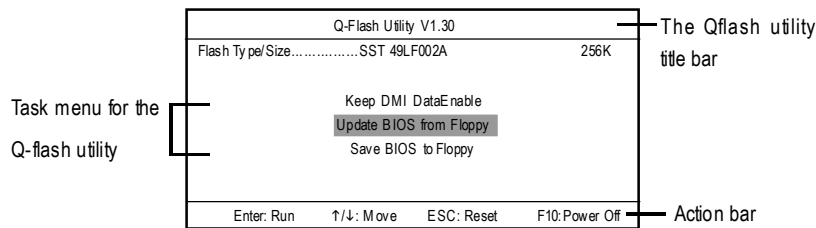

**Task menu for the Q-Flash™ utility:** Contains the names of three tasks. Blocking a task and pressing **Enter** key on your keyboard to enable execution of the task.

**Action bar:** Contains the names of four actions needed to operate the Q-Flash™ utility. Pressing the buttons mentioned on your keyboard to perform these actions.

#### Using the Q-Flash™ utility:

This section tells you how to update BIOS using the Q-Flash™ utility. As described in the "Before you begin" section above, you must prepare a floppy disk having the BIOS file for your motherboard and insert it to your computer. If you have already put the floppy disk into your system and have entered the Q-Flash™ utility, please follow the steps below to flash BIOS.

#### Steps:

1. Press arrow buttons on your keyboard to move the light bar to "Load Main BIOS from Floppy" item in the Q-Flash™ menu and press **Enter** button.



If you want to save the current BIOS for backup purpose, you can begin Step 1 with **Save Main BIOS to Floppy** item.

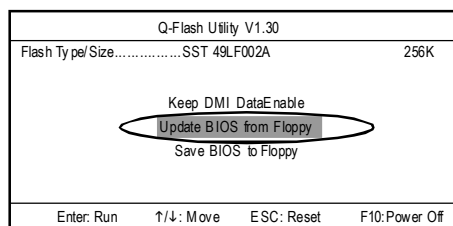

Later, you will see a box showing the BIOS files you downloaded to the floppy disk. In this example, we only download one BIOS for this board, 8GE800.F4 so only one BIOS file is listed.

2. Highlight the BIOS file you want to flash and press **Enter** button on your keyboard to enable reading from the BIOS file from the floppy.

 Please confirm again you have the correct BIOS file for your motherboard.

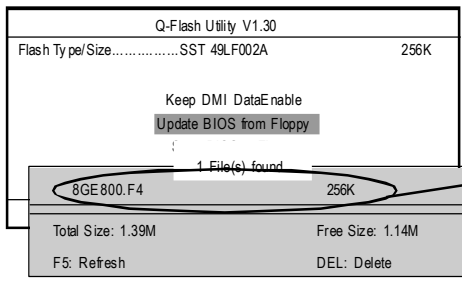

BIOS file in the floppy.

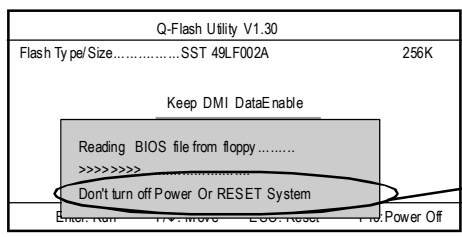

 Do not turning power or reset your system at this stage!

After BIOS file is read, you'll see a confirmation dialog box asking you "Are you sure to update BIOS?"

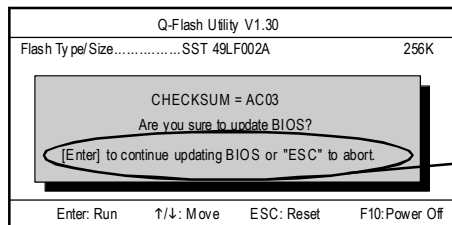

You can press "Enter" to continue updating BIOS or "ESC" to abort.

3. Press **Y** button if you make sure to update BIOS.

Then it will begin to update BIOS. The progress of updating will be shown at the same time.

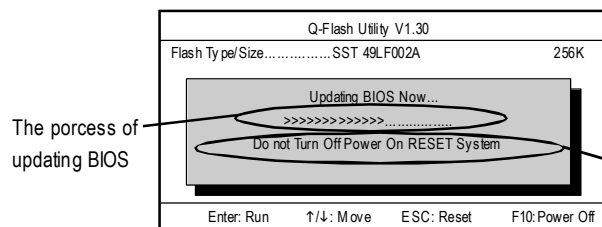

Do not turning off power or reset your system at this stage!!

4. Press any keys to return to the Q-Flash™ menu when the BIOS updating procedure is completed.

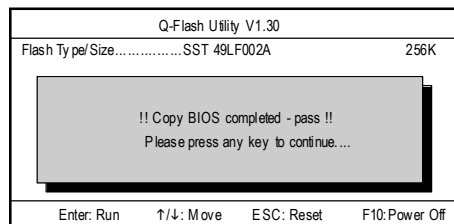

5. Press **Esc** and then **Enter** to exit the Q-Flash™ utility. System will restart.

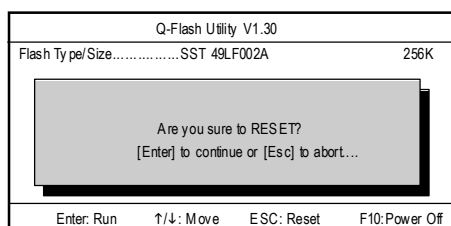

6. Press **Del** to enter BIOS menu after system reboots and load BIOS Fail-Safe Defaults. See how to load BIOS Fail-Safe Defaults, please kindly refer to Step 6 to 7 in Part One.

**Congratulation!! You have updated BIOS successfully!!**

**Method 2: @ BIOS Utility**

If you don't have DOS boot disk, we recommend that you used Gigabyte @BIOS™ program to flash BIOS.



(1)

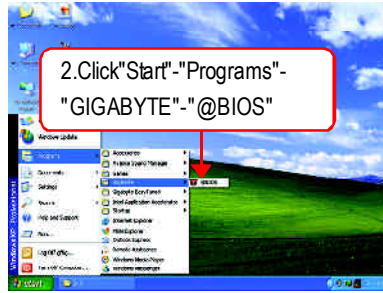

(2)

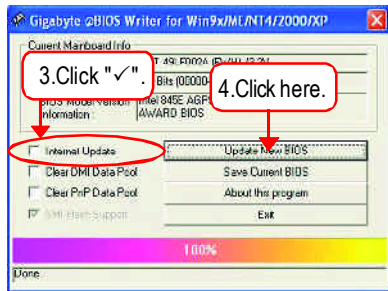

(3)

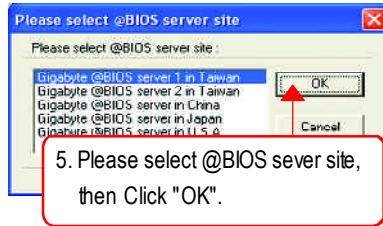

(4)

**Methods and steps:**

- I. Update BIOS through Internet
  - a. Click "Internet Update" icon
  - b. Click "Update New BIOS" icon
  - c. Select @BIOS™ sever
  - d. Select the exact model name on your motherboard
  - e. System will automatically download and update the BIOS.

## II. Update BIOS NOT through Internet

- a. Do not click "Internet Update" icon
- b. Click "Update New BIOS"
- c. Please select "All Files" in dialog box while opening the old file.
- d. Please search for BIOS unzip file, downloading from internet or any other methods (such as: 8S650GXM-P.F1).
- e. Complete update process following the instruction.

## III. Save BIOS

In the very beginning, there is "Save Current BIOS" icon shown in dialog box. It means to save the current BIOS version.

## IV. Check out supported motherboard and Flash ROM:

In the very beginning, there is "About this program" icon shown in dialog box. It can help you check out which kind of motherboard and which brand of Flash ROM are supported.

### Note:

- a. In method I, if it shows two or more motherboard's model names to be selected, please make sure your motherboard's model name again. Selecting wrong model name will cause the system unbooted.
- b. In method II, be sure that motherboard's model name in BIOS unzip file are the same as your motherboard's. Otherwise, your system won't boot.
- c. In method I, if the BIOS file you need cannot be found in @BIOS™ server, please go onto Gigabyte's web site for downloading and updating it according to method II.
- d. Please note that any interruption during updating will cause system unbooted.

## 2-/4-/6-Channel Audio Function Introduction

The installation of windows 98SE/2K/ME/XP is very simple. Please follow next step to install the function!

### Stereo Speakers Connection and Settings:

We recommend that you use the speaker with amplifier to acquire the best sound effect if the stereo output is applied.

#### STEP 1:

Connect the stereo speakers or earphone to "Line Out".

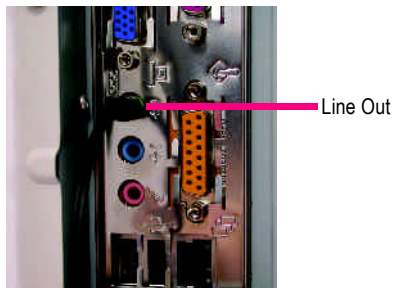

#### STEP 2 :

After installation of the audio driver, you'll find an  icon on the taskbar's status area. Click the audio icon "Sound Effect" from the windows tray at the bottom of the screen.

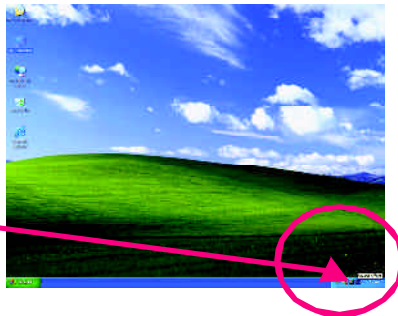

#### STEP 3:

Select "Speaker Configuration", and choose the "2 channels for stereo speakers out put".



### 4 Channel Analog Audio Output Mode

STEP 1 :

Connect the front channels to "Line Out",  
the rear channels to "Line In".

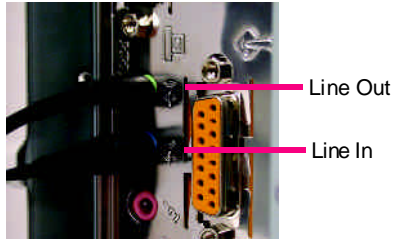

STEP 2 :

After installation of the audio driver, you'll find an  icon on the taskbar's status area. Click the audio icon "Sound Effect" from the windows tray at the bottom of the screen.



STEP 3 :

Select "Speaker Configuration", and choose the "4 channels for 4 speakers out put".  
Disable "Only SURROUND-KIT",  
and press "OK".

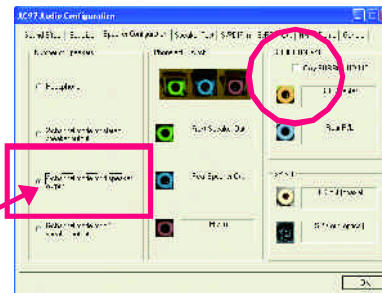
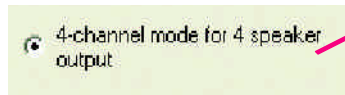

When the "Environment settings" is "None", the sound would be performed as stereo mode (2 channels output). Please select the other settings for 4 channels output.

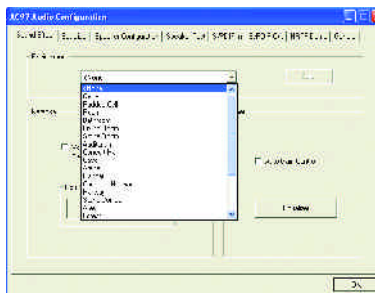

### Basic 6 Channel Analog Audio Output Mode

Use the back audio panel to connect the audio output without any additional module.

STEP 1 :

Connect the front channels to "Line Out", the rear channels to "Line In", and the Center/Subwoofer channels to "MIC In".

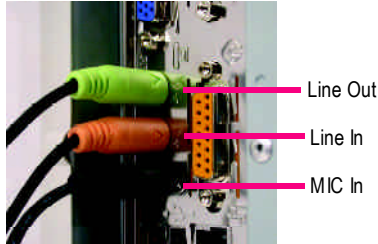

STEP 2 :

After installation of the audio driver, you'll find an  icon on the taskbar's status area. Click the audio icon "Sound Effect" from the windows tray at the bottom of the screen.

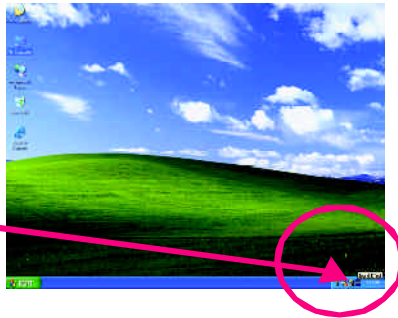

STEP 3 :

Select "Speaker Configuration", and choose the "6 channels for 5.1 speakers output". Disable "Only SURROUND-KIT" and press "OK".

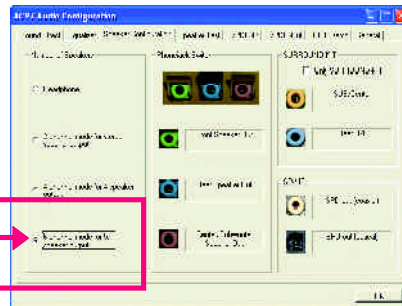
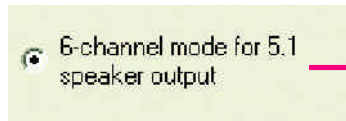



**Advanced 6 Channel Analog Audio Output Mode (using Audio Combo Kit,Optional Device):**

(Audio Combo Kit provides SPDIF output port : optical & coaxial and SURROUND-KIT : Rear R/L & CEN /Subwoofer)

SURROUND-KIT access analog output to rear channels and Center/Subwoofer channels. It is the best solution if you need 6 channel output, Line In and MIC at the same time. "SURROUND-KIT" is included in the GIGABYTE unique "Audio Combo Kit" as picture.



**STEP 1 :**

Insert the "SURROUND-KIT" in the back of the case ,and fix it with the screw.



**STEP 2 :**

Connect the "SURROUND-KIT" to SUR\_CEN on the M/B.

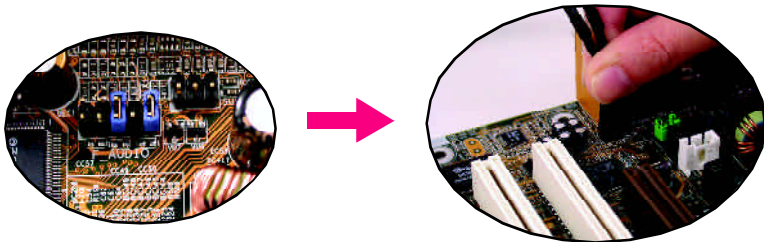

**STEP 3 :**

Connect the front channels to back audio panel's "Line Out", the rear channels to SURROUND-KIT's REAR R/L, and the Center/Subwoofer channels to SURROUND-KIT's SUB CENTER.

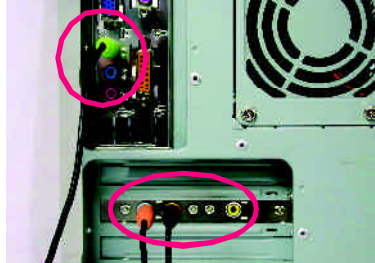

**STEP 4 :**

Click the audio icon "Sound Effect" from the windows tray at the bottom of the screen.

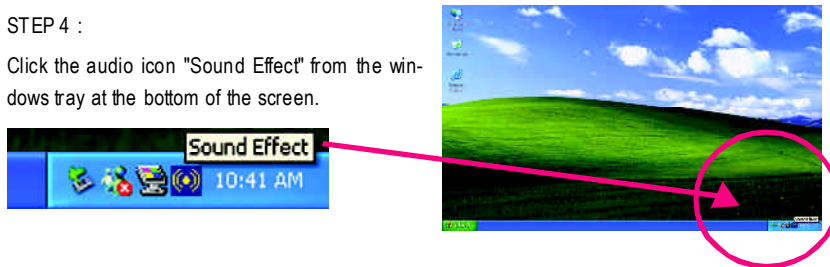

**STEP 5 :**

Select "Speaker Configuration", and choose the "6 channels for 5.1 speakers output". Enable "Only SURROUND-KIT" and press "OK".

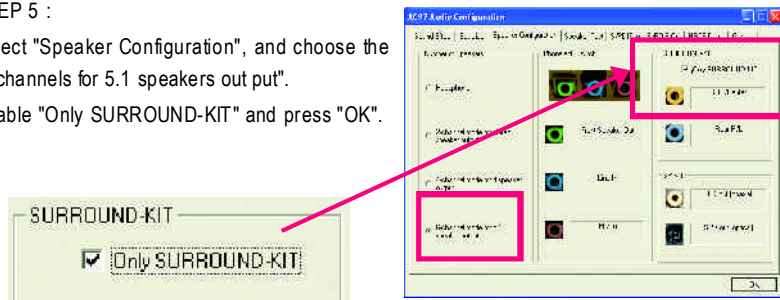

**Basic & Advanced 6 Channel Analog Audio Output Mode Notes:**

When the "Environment settings" is "None", the sound would be performed as stereo mode (2 channels output). Please select the other settings for 6 channels output.

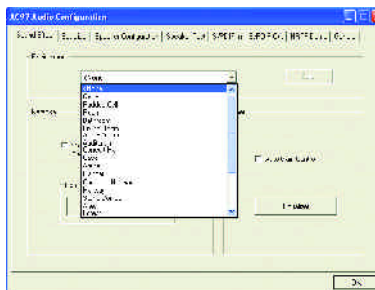

### **SPDIF Output Device (Optional Device)**

A "SPDIF output" device is available on the motherboard. Cable with rear bracket is provided and could link to the "SPDIF output" connector (As picture.) For the further linkage to decoder, rear bracket provides coaxial cable and Fiber connecting port



1. Connect the SPDIF output device to the rear bracket of PC, and fix it with screw.



2. Connect SPDIF device to the motherboard.

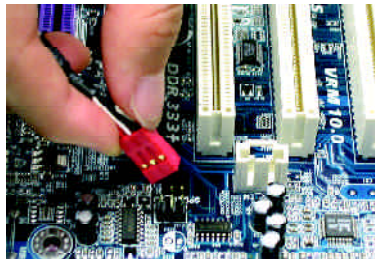

3. Connect SPDIF to the SPDIF decoder.





## Chapter 5 Appendix

### Install Drivers



#### Pictures below are shown in Windows XP (CD ver. 2.4)

Insert the driver CD-title that came with your motherboard into your CD-ROM drive, the driver CD-title will auto start and show the installation guide. If not, please double click the CD-ROM device icon in "My computer", and execute the setup.exe.

### INSTALL CHIPSET DRIVER

This page shows the drivers that need to be installed for the system. Click each item to install the driver manually or switch to the  to install the drivers automatically.

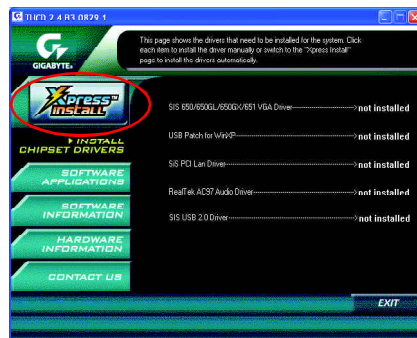

Message: Some device drivers will restart your system automatically. After restarting your system the "Xpress Install" will continue to install other drivers.

The "Xpress Install" uses the "Click and Forget" technology to install the drivers automatically. Just select the drivers you want then click the "GO" button. The  will execute the installation for you by itself.

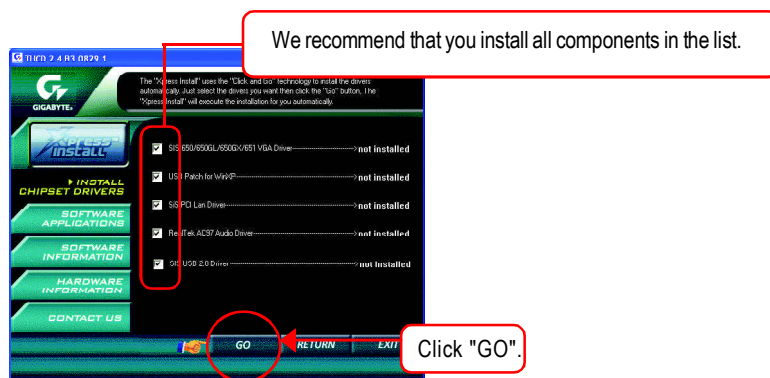



Driver install finished!! you have to reboot system!!

### Item Description

- SiS 650/650GL/650GX/651 VGA Driver  
VGA driver for VGA integrated SiS 650/650GL/650GX/651 chipset.
- USB Patch for WinXP  
This patch driver can help you to resolve the USB device wake up S3 hang up issue in XP.
- SiS PCI Lan Driver <sup>(①)</sup>  
SiS 962L/963L LAN driver.
- RealTek AC97 Audio Driver  
Install RealTek AC97 audio driver.
- SiS USB 2.0 Driver  
It is recommended that you use the Microsoft Windows update for the most updated driver for XP/2K.



If your CD doesn't have SiS® USB2.0 driver, please download the USB2.0 driver from Microsoft® website ([www.microsoft.com](http://www.microsoft.com)) for USB2.0 devices support. Please also note that Microsoft® USB2.0 driver is currently supported by Windows XP and Windows 2000 only. Once we get the latest SiS® USB2.0 driver for Windows 98 and Windows ME, we will put the driver on GIGABYTE website asap. (<http://www.gigabyte.com.tw>).



For USB2.0 driver support under Windows XP operating system, please use Windows Service Pack. After install Windows Service Pack, it will show a question mark "?" in "Universal Serial Bus controller" under "Device Manager". Please remove the question mark and restart the system (System will auto-detect the right USB2.0 driver).

① For GA-8S650GXM-P only.

## SOFTWARE APPLICATION

This page reveals the value-added software developed by Gigabyte and its worldwide partners.



- Gigabyte Windows Utilities Manager(GWUM)  
This utility can integrate the Gigabyte's applications in the system tray.
- Gigabyte Management Tool(GMT)  
A useful tool which can manage the computer via the network.
- EasyTune4  
Powerful utility that integrates the overclocking and hardware monitoring functions.
- DMI Viewer  
Windows based utility which is used to browse the DMI/SMBIOS information of the system.
- Face-Wizard  
New utility for adding BIOS logo.
- @BIOS  
Gigabyte windows flash BIOS utility.
- Acrobat e-Book  
Useful utility from Adobe.
- Acrobat Reader  
Popular utility from Adobe for reading .PDF file format documents.
- Norton Internet Security(NIS)  
Integrated utility which includes anti-virus, ad control, etc
- DirectX 9.0  
Install Microsoft DirectX 9 to enable 3D hardware acceleration that support for operating system to achieve better 3D performance.

## SOFTWARE INFORMATION

This page list the contents of softwares and drivers in this CD title.

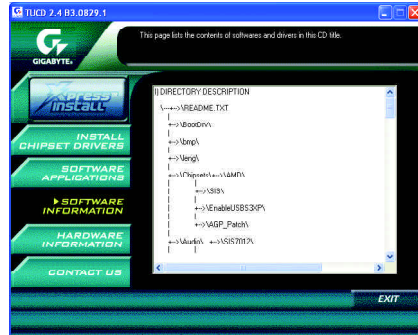

## HARDWARE INFORMATION

This page lists all device you have for this motherboard.

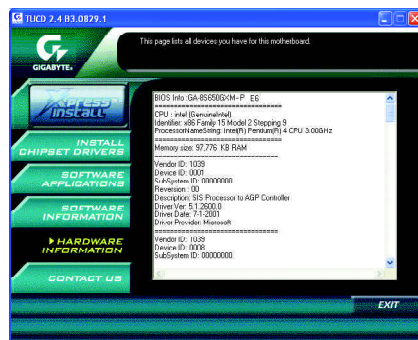

## CONTACT US

Please see the last page for details.





## FAQ

Below is a collection of general asked questions. To check general asked questions based on a specific motherboard model, please log on to <http://tw.giga-byte.com/faq/faq.htm>

**Question 1:** I cannot see some options that were included in previous BIOS after updating BIOS. Why?

**Answer:** Some advanced options are hidden in new BIOS version. Please press Ctrl and F1 keys after entering BIOS menu and you will be able to see these options.

**Questions 2:** Why is the light of my keyboard/optical mouse still on after computer shuts down?

**Answer:** In some boards, a small amount of electricity is kept on standby after computer shuts down and that's why the light is still on.

**Question 3:** Why cannot I use all functions in EasyTune™ 4?

**Answer:** The availability of the listed functions in EasyTune™ 4 depends on the MB chipset. If the chipset doesn't support certain functions in EasyTune™ 4, these functions will be locked automatically and you will not be able to use them.

**Question 4:** Why do I fail to install RAID and ATA drivers under Win 2000 and XP on boards that support RAID function after I connect the boot HDD to IDE3 or IDE4 ?

**Answer:** First of all, you need to save some files in the CD-ROM to a floppy disk before installing drivers. You also need to go through some rather different steps in the installation process. Therefore, we suggest that you refer to the installation steps in the RAID manual at our website.

(Please download it at [http://tw.giga-byte.com/support/user\\_pdf/raid\\_manual.pdf](http://tw.giga-byte.com/support/user_pdf/raid_manual.pdf))

**Question 5:** How do I clear CMOS?

**Answer:** If your board has a Clear CMOS jumper, please refer to the Clear CMOS steps in the manual. If your board doesn't have such jumper, you can take off the on-board battery to leak voltage to clear CMOS. Please refer to the steps below:

Steps:

1. Turn off power.
2. Disconnect the power cord from MB.
3. Take out the battery gently and put it aside for about 10 minutes (Or you can use a metal object to connect the positive and negative pins in the battery holder to make them short for one minute).
4. Re-insert the battery to the battery holder.
5. Connect power cord to MB again and turn on power.
6. Press Del to enter BIOS and load Fail-Safe Defaults.
7. Save changes and reboot the system.

**Question 6:** Why does system seem unstable after updating BIOS?

**Answer:** Please remember to load Fail-Safe Defaults (Or Load BIOS Defaults) after flashing BIOS. However, if the system instability still remains, please clear CMOS to solve the problem.

**Question 7:** Why do I still get a weak sound after turning up the speaker to the maximum volume?

**Answer:** Please make sure the speaker you are using is equipped with an internal amplifier. If not, please change another speaker with power/amplifier and try again later.

**Question 8:** How do I disable onboard VGA card in order to add an external VGA card?

**Answer:** Gigabyte motherboards will auto-detect the external VGA card after it is plugged in, so you don't need to change any setting manually to disable the onboard VGA.

**Question 9:** Why cannot I use the IDE 2?

**Answer:** Please refer to the user manual and check whether you have connected any cable that is not provided with the motherboard package to the USB Over Current pin in the Front USB Panel. If the cable is your own cable, please remove it from this pin and do not connect any of your own cables to it.

**Question 10:** Sometimes I hear different continuous beeps from computer after system boots up. What do these beeps usually stand for?

**Answer:** The beep codes below may help you identify the possible computer problems. However, they are only for reference purposes. The situations might differ from case to case.

→ AMI BIOS Beep Codes

\*Computer gives 1 short beep when system boots successfully.

\*Except for beep code 8, these codes are always fatal.

- 1 beep Refresh failure
- 2 beeps Parity error
- 3 beeps Base 64K memory failure
- 4 beeps Timer not operational
- 5 beeps Processor error
- 6 beeps 8042 - gate A20 failure
- 7 beeps Processor exception interrupt error
- 8 beeps Display memory read/write failure
- 9 beeps ROM checksum error
- 10 beeps CMOS shutdown register read/write error
- 11 beeps Cache memory bad

→ AWARD BIOS Beep Codes

- 1 short: System boots successfully
- 2 short: CMOS setting error
- 1 long 1 short: DRAM or M/B error
- 1 long 2 short: Monitor or display card error
- 1 long 3 short: Keyboard error
- 1 long 9 short: BIOS ROM error
- Continuous long beeps: DRAM error
- Continuous short beeps: Power error

**Question 11:** How to set in the BIOS in order to bootup from SATA HDDs by either RAID or ATA mode?

**Answer:** Please set in the BIOS as follow:

1. Advanced BIOS features--> SATA/RAID/SCSI boot order: "SATA"
2. Advanced BIOS features--> First boot device: "SCSI"
3. Integrated Peripherals--> Onboard H/W Serial ATA: "enable"

Then it depends on the SATA mode that you need to set "RAID" to RAID mode or "BASE" to normal ATA mode in the item named Serial ATA function.

**Question 12:**For the M/B which have RAID function, how to set in the BIOS in order to bootup from IDE3, 4 by either RAID or ATA mode?

**Answer:**Please set in the BIOS as follow:

1. Advanced BIOS features-->(SATA)/RAID/SCSI boot order: "SATA"
2. Advanced BIOS features--> First boot device: "SCSI"
3. Integrated Peripherals--> Onboard H/W ATA/RAID: "enable"

Then it depends on the RAID mode that you need to set "RAID" to RAID mode or "ATA" to normal ATA mode in the item named RAID controller function.

**Question 13:**How to set in the BIOS to bootup from the IDE/ SCSI/ RAID card ?

**Answer:**Please set in the BIOS as follow:

1. Advanced BIOS features-->(SATA)/RAID/SCSI boot order: "SCSI"
2. Advanced BIOS features--> First boot device: "SCSI"

Then it depends on the mode(RAID or ATA) that you need to set in RAID/ SCSI BIOS.

## Troubleshooting



If you encounter any trouble during boot up, please follow the troubleshooting procedures.

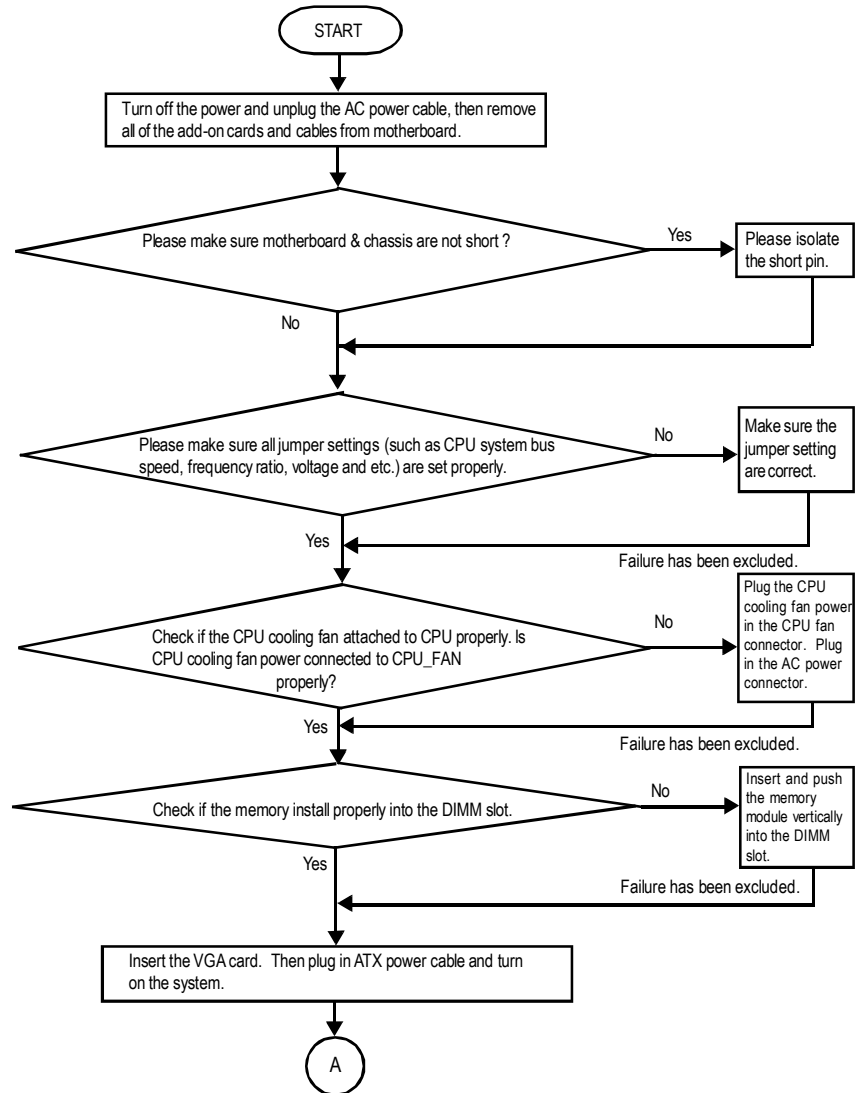

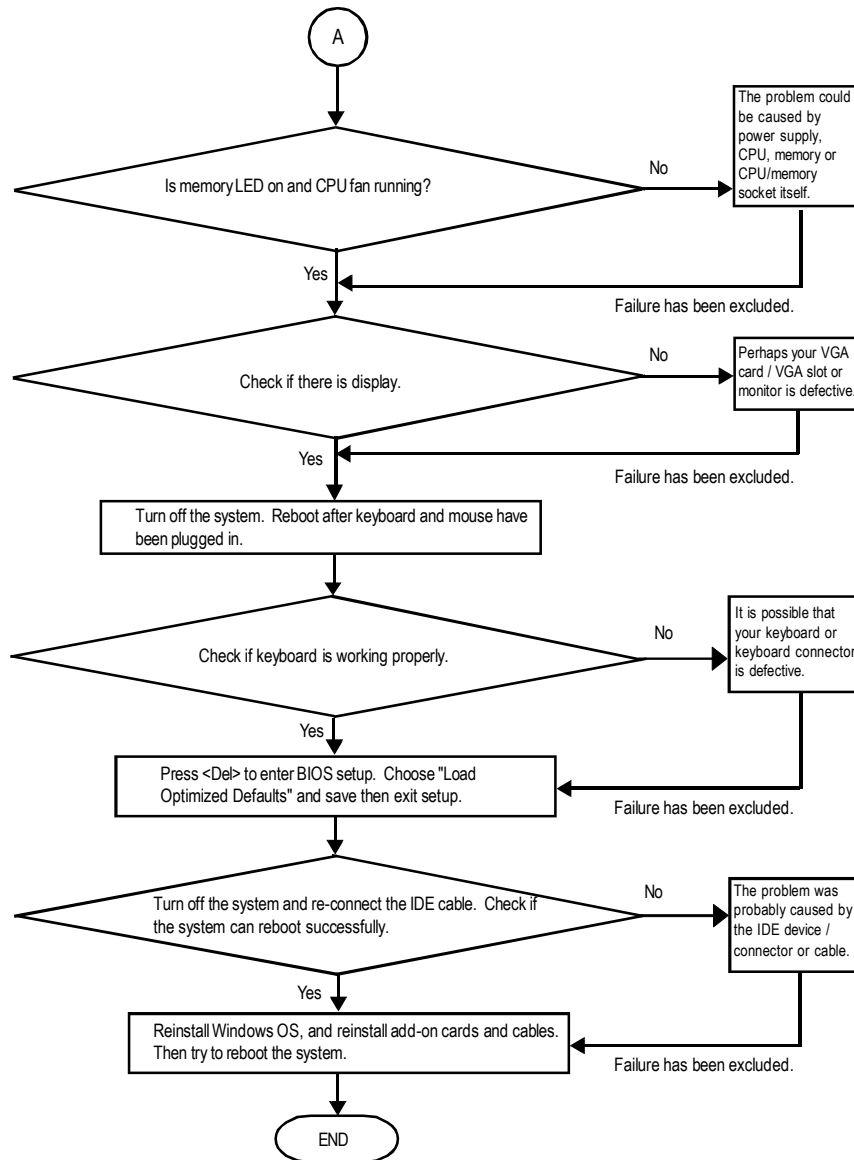

If the above procedure unable to solve your problem, please contact with your local retailer or national distributor for help. Or, you could submit your question to the service mail via Gigabyte website technical support zone (<http://www.gigabyte.com.tw>). The appropriate response will be provided ASAP.

## Technical Support/RMA Sheet

Customer/Country:	Company:	Phone No.:
Contact Person:	E-mail Add. :	

Model name/Lot Number:	PCB revision:
BIOS version:	O.S./A.S.:

Hardware Configuration	Mfs.	Model name	Size:	Driver/Utility:
CPU				
Memory				
Brand				
Video Card				
Audio Card				
HDD				
CD-ROM / DVD-ROM				
Modem				
Network				
AMR / CNR				
Keyboard				
Mouse				
Power supply				
Other Device				

Problem Description:

\_\_\_\_\_

\_\_\_\_\_

## Acronyms

Acronyms	Meaning
ACPI	Advanced Configuration and Power Interface
APM	Advanced Power Management
AGP	Accelerated Graphics Port
AMR	Audio Modem Riser
ACR	Advanced Communications Riser
BIOS	Basic Input / Output System
CPU	Central Processing Unit
CMOS	Complementary Metal Oxide Semiconductor
CRIMM	Continuity RIMM
CNR	Communication and Networking Riser
DMA	Direct Memory Access
DMI	Desktop Management Interface
DIMM	Dual Inline Memory Module
DRM	Dual Retention Mechanism
DRAM	Dynamic Random Access Memory
DDR	Double Data Rate
ECP	Extended Capabilities Port
ESCD	Extended System Configuration Data
ECC	Error Checking and Correcting
EMC	Electromagnetic Compatibility
EPP	Enhanced Parallel Port
ESD	Electrostatic Discharge
FDD	Floppy Disk Device
FSB	Front Side Bus
HDD	Hard Disk Device
IDE	Integrated Dual Channel Enhanced
IRQ	Interrupt Request

to be continued.....



Acronyms	Meaning
IOAPIC	Input Output Advanced Programmable Input Controller
ISA	Industry Standard Architecture
LAN	Local Area Network
I/O	Input / Output
LBA	Logical Block Addressing
LED	Light Emitting Diode
MHz	Megahertz
MIDI	Musical Instrument Digital Interface
MTH	Memory Translator Hub
MPT	Memory Protocol Translator
NIC	Network Interface Card
OS	Operating System
OEM	Original Equipment Manufacturer
PAC	PCI A.G.P. Controller
POST	Power-On Self Test
PCI	Peripheral Component Interconnect
RIMM	Rambus in-line Memory Module
SCI	Special Circumstance Instructions
SECC	Single Edge Contact Cartridge
SRAM	Static Random Access Memory









---

---

---

---

---

---

---

---

---

---

---

---

---

---

---

---

---

---

---

---

---

---

---

---

---

---

---

---

---



## CONTACT US

Contact us via the information in this page all over the world.

- Taiwan

Gigabyte Technology Co., Ltd.

Address: No.6, Bau Chiang Road, Hsin-Tien, Taipei Hsien, Taiwan, R.O.C.

TEL: 886 (2) 8912-4888

FAX: 886 (2) 8912-4004

E-mail:

We have been constantly striving hard to provide you with faster and more efficient mail replying service.

If you have any inquiry please classify it into the following topics.

The respective department will attend to the inquiry as soon as possible. Thank you for your cooperation!

WEB Address: <http://tw.giga-byte.com>

- USA

G.B.T. INC.

Address: 17358 Railroad St, City of Industry, CA 91748.

Tel: 1 (626) 854-9338

Fax: 1 (626) 854-9339

E-mail: [sales@giga-byte.com](mailto:sales@giga-byte.com)

[support@giga-byte.com](mailto:support@giga-byte.com)

WEB Address: <http://us.giga-byte.com>

- Germany

G.B.T. Technology Trading GmbH

Tel: 49-40-2533040

49-01803-428468 (Tech.)

Fax: 49-40-25492343 (Sales)

49-01803-428329 (Tech.)

E-mail: [support@gigabyte.de](mailto:support@gigabyte.de)

WEB Address: <http://de.giga-byte.com>

- Japan

Nippon Giga-Byte Corporation

WEB Address: <http://www.gigabyte.co.jp>

- U.K

G.B.T. TECH. CO. LTD.

Tel: 44-1908-362700

Fax: 44-1908-362709

E-mail: [support@gbt-tech.co.uk](mailto:support@gbt-tech.co.uk)

WEB Address: <http://uk.giga-byte.com>

- The Netherlands

Giga-Byte Technology B.V.

Address: Verdunplein 8 5627 SZ, Eindhoven, The Netherlands

Tel: +31 40 290 2088

NL Tech.Support : 0900-GIGABYTE (0900-44422983, €0.2/M)

BE Tech.Support : 0900-84034 (€0.4/M)

Fax: +31 40 290 2089

E-mail: [info@giga-byte.nl](mailto:info@giga-byte.nl)

Tech. Support E-mail: [support@giga-byte.nl](mailto:support@giga-byte.nl)

WEB Address: <http://nl.giga-byte.com>

- China

Shanghai Office

Tel: 86-21-64737410

Fax: 86-21-64453227

WEB Address: <http://cn.giga-byte.com>

GuangZhou Office

Tel: 86-20-87586273

Fax: 86-20-87544306

WEB Address: <http://cn.giga-byte.com>

Beijing Office

Tel: 86-10-82856054

86-10-82856064

86-10-82856094

Fax: 86-10-82856575

E-mail: [bjsupport@gigabyte.com.cn](mailto:bjsupport@gigabyte.com.cn)

WEB Address: <http://cn.giga-byte.com>

Chengdu Office

Tel: 86-28-85236930

Fax: 86-28-85256822

WEB Address: <http://cn.giga-byte.com>