

GA200NS61U

High Side Switch Chopper Module
 Ultra-Fast™ Speed IGBT

Features

- Generation 4 IGBT technology
- UltraFast: Optimized for high operating frequencies 8-40 kHz in hard switching, >200 kHz in resonant mode
- Very low conduction and switching losses
- HEXFRED™ antiparallel diodes with ultra- soft recovery
- Industry standard package
- UL approved

Benefits

- Increased operating efficiency
- Direct mounting to heatsink
- Performance optimized for power conversion: UPS, SMPS, Welding
- Lower EMI, requires less snubbing

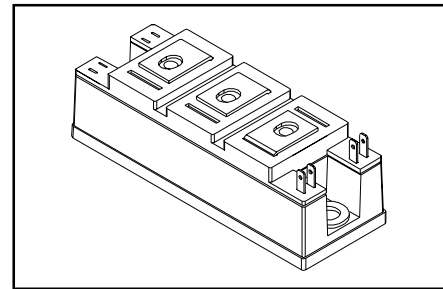
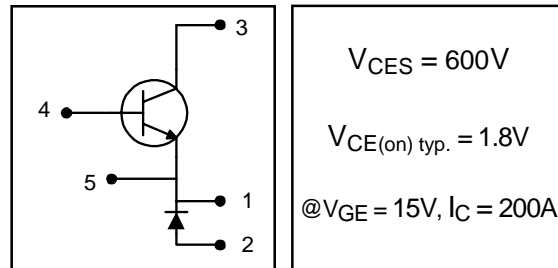

Absolute Maximum Ratings

	Parameter	Max.	Units
V_{CES}	Collector-to-Emitter Voltage	600	V
$I_C @ T_C = 25^\circ C$	Continuous Collector Current	200	A
I_{CM}	Pulsed Collector Current [Ⓞ]	400	
I_{LM}	Peak Switching Current [Ⓞ]	400	
I_{FM}	Peak Diode Forward Current	400	
V_{GE}	Gate-to-Emitter Voltage	±20	V
V_{ISOL}	RMS Isolation Voltage, Any Terminal To Case, t = 1 min	2500	
$P_D @ T_C = 25^\circ C$	Maximum Power Dissipation	625	W
$P_D @ T_C = 85^\circ C$	Maximum Power Dissipation	325	
T_J	Operating Junction Temperature Range	-40 to +150	°C
T_{STG}	Storage Temperature Range	-40 to +125	

Thermal / Mechanical Characteristics

	Parameter	Typ.	Max.	Units
$R_{\theta JC}$	Thermal Resistance, Junction-to-Case - IGBT	—	0.20	°C/W
$R_{\theta JC}$	Thermal Resistance, Junction-to-Case - Diode	—	0.35	
$R_{\theta CS}$	Thermal Resistance, Case-to-Sink - Module	0.1	—	N·m
	Mounting Torque, Case-to-Heatsink	—	4.0	
	Mounting Torque, Case-to-Terminal 1, 2 & 3 [Ⓞ]	—	3.0	
	Weight of Module	200	—	g

Electrical Characteristics @ $T_J = 25^\circ\text{C}$ (unless otherwise specified)

	Parameter	Min.	Typ.	Max.	Units	Conditions
$V_{(BR)CES}$	Collector-to-Emitter Breakdown Voltage	600	—	—	V	$V_{GE} = 0V, I_C = 1mA$
$V_{CE(on)}$	Collector-to-Emitter Voltage	—	1.8	2.2		$V_{GE} = 15V, I_C = 200A$
		—	1.9	—		$V_{GE} = 15V, I_C = 200A, T_J = 125^\circ\text{C}$
$V_{GE(th)}$	Gate Threshold Voltage	3.0	—	6.0		$I_C = 1.25mA$
$\Delta V_{GE(th)}/\Delta T_J$	Temperature Coeff. of Threshold Voltage	—	-11	—	mV/°C	$V_{CE} = V_{GE}, I_C = 1.25mA$
g_{fe}	Forward Transconductance \oplus	—	175	—	S	$V_{CE} = 25V, I_C = 200A$
I_{CES}	Collector-to-Emitter Leaking Current	—	—	1.0	mA	$V_{GE} = 0V, V_{CE} = 600V$
		—	—	10		$V_{GE} = 0V, V_{CE} = 600V, T_J = 125^\circ\text{C}$
V_{FM}	Diode Forward Voltage - Maximum	—	1.6	2.2	V	$I_F = 200A, V_{GE} = 0V$
		—	1.7	—		$I_F = 200A, V_{GE} = 0V, T_J = 125^\circ\text{C}$
I_{GES}	Gate-to-Emitter Leakage Current	—	—	250	nA	$V_{GE} = \pm 20V$

Dynamic Characteristics - $T_J = 125^\circ\text{C}$ (unless otherwise specified)

	Parameter	Min.	Typ.	Max.	Units	Conditions
Q_g	Total Gate Charge (turn-on)	—	903	1355	nC	$V_{CC} = 400V, V_{GE} = 15V$
Q_{ge}	Gate - Emitter Charge (turn-on)	—	125	188		$I_C = 135A$
Q_{gc}	Gate - Collector Charge (turn-on)	—	306	459		$T_J = 25^\circ\text{C}$
$t_{d(on)}$	Turn-On Delay Time	—	342	—	ns	$R_{G1} = 27\Omega, R_{G2} = 0\Omega,$
t_r	Rise Time	—	194	—		$I_C = 200A$
$t_{d(off)}$	Turn-Off Delay Time	—	366	—		$V_{CC} = 360V$
t_f	Fall Time	—	213	—		$V_{GE} = \pm 15V$
E_{on}	Turn-On Switching Energy	—	12	—	mJ	Inductive load
$E_{off(1)}$	Turn-Off Switching Energy	—	16	—		
$E_{ts(1)}$	Total Switching Energy	—	28	39		
C_{ies}	Input Capacitance	—	20068	—	pF	$V_{GE} = 0V$
C_{oes}	Output Capacitance	—	1254	—		$V_{CC} = 30V$
C_{res}	Reverse Transfer Capacitance	—	261	—		$f = 1\text{ MHz}$
t_{rr}	Diode Reverse Recovery Time	—	137	—	ns	$I_C = 200A$
I_{rr}	Diode Peak Reverse Current	—	96	—		$R_{G1} = 27\Omega$
Q_{rr}	Diode Recovery Charge	—	6731	—	μC	$R_{G2} = 0\Omega$
$di_{(rec)M}/dt$	Diode Peak Rate of Fall of Recovery During t_b	—	5705	—	A/ μs	$V_{CC} = 360V$ $di/dt = 1227A/\mu\text{s}$

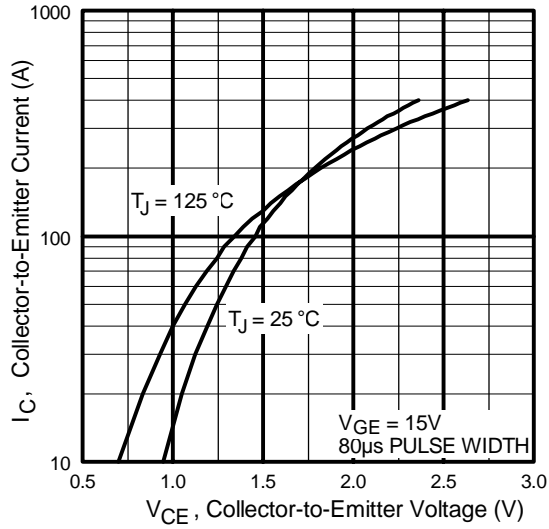

Fig. 1 - Typical Output Characteristics

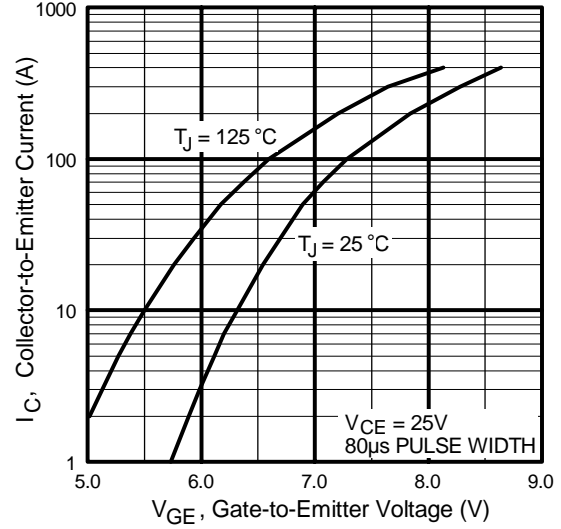

Fig. 2 - Typical Transfer Characteristics

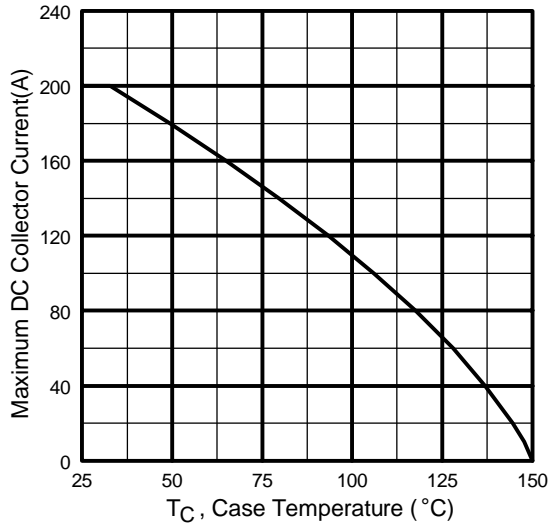

Fig. 3 - Maximum Collector Current vs. Case Temperature

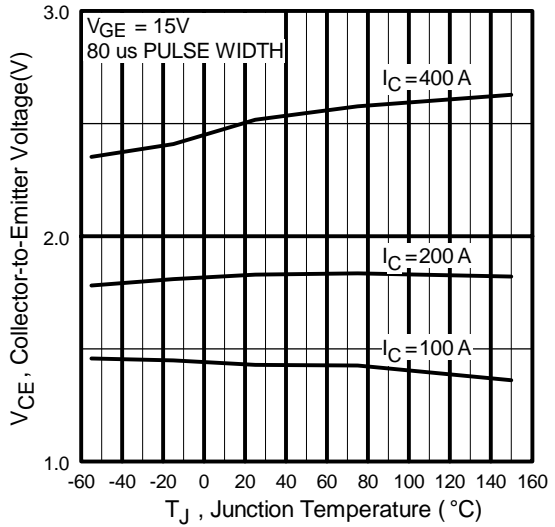

Fig. 4 - Typical Collector-to-Emitter Voltage vs. Junction Temperature

GA200NS61U

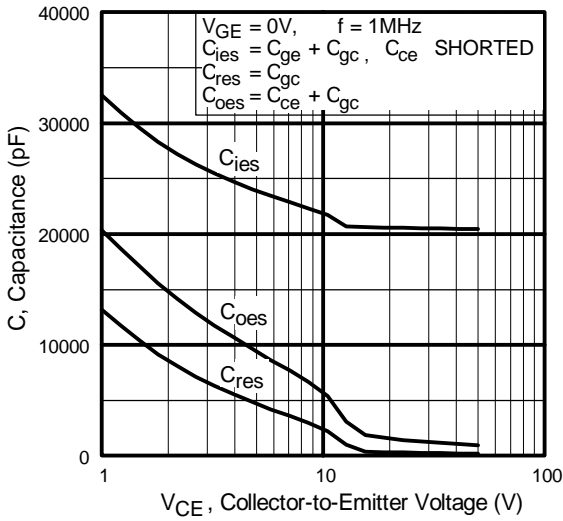

Fig. 5 - Typical Capacitance vs. Collector-to-Emitter Voltage

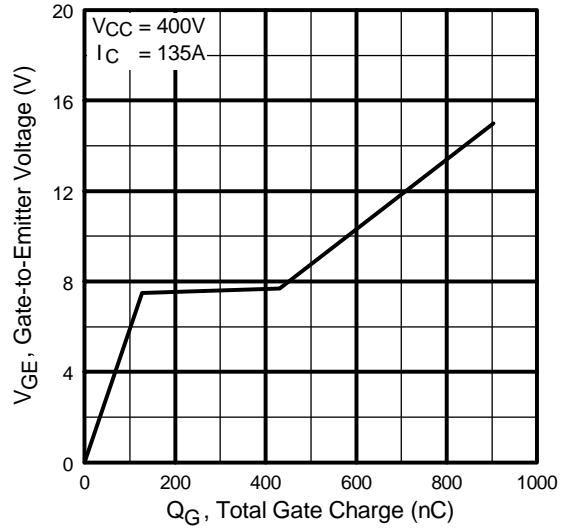

Fig. 6 - Typical Gate Charge vs. Gate-to-Emitter Voltage

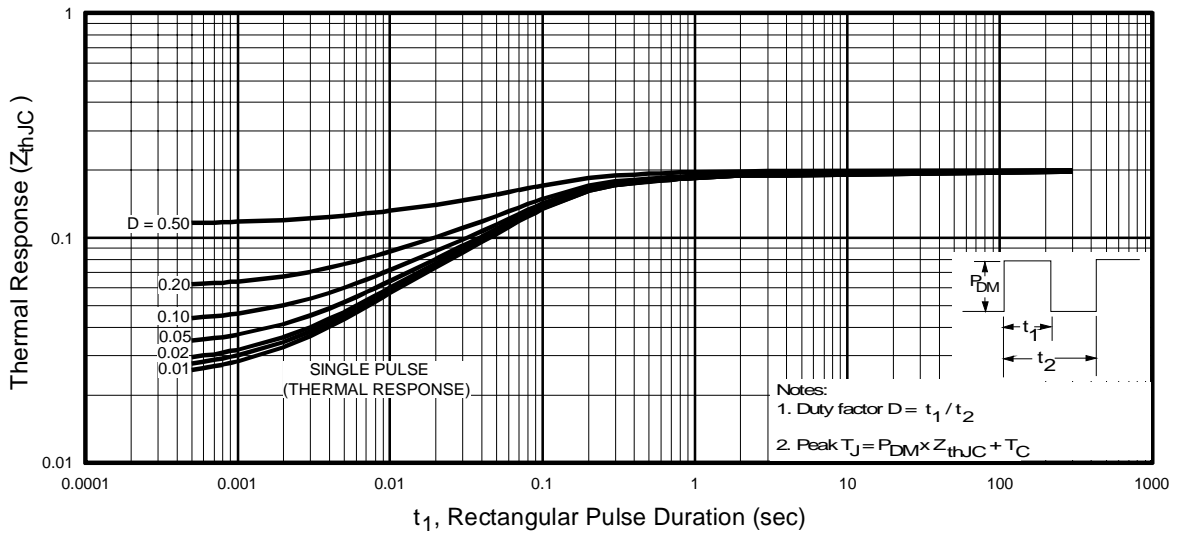

Fig. 7 - Maximum Effective Transient Thermal Impedance, Junction-to-Case

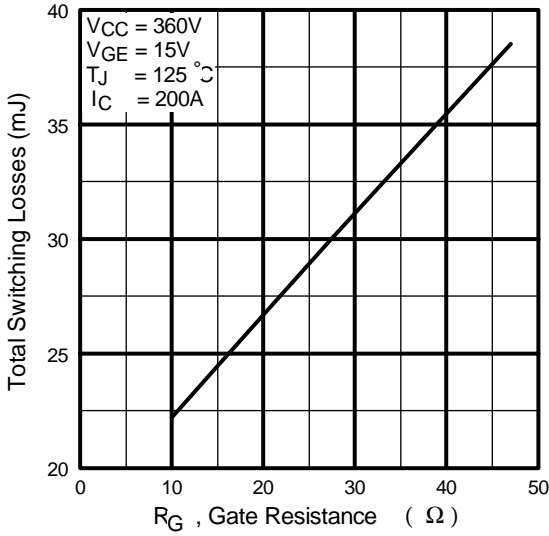

Fig. 8 - Typical Switching Losses vs. Gate Resistance

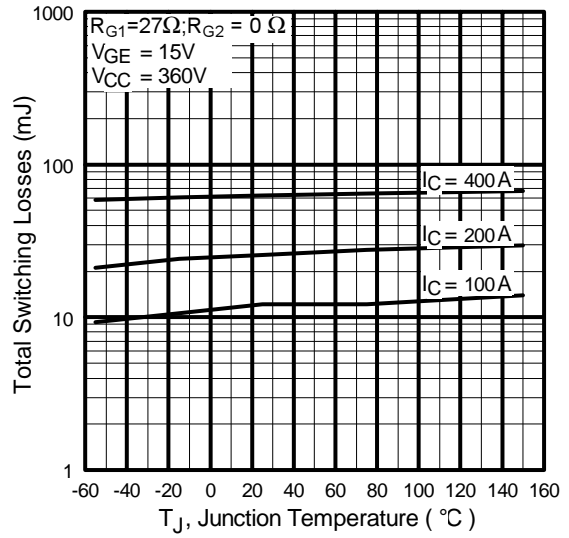

Fig. 9 - Typical Switching Losses vs. Junction Temperature

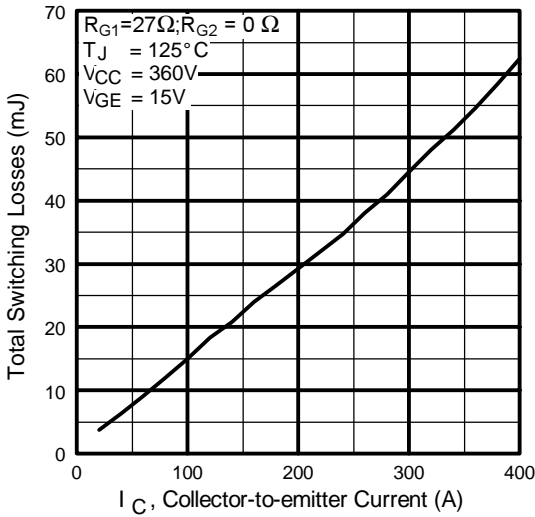

Fig. 10 - Typical Switching Losses vs. Collector-to-Emitter Current

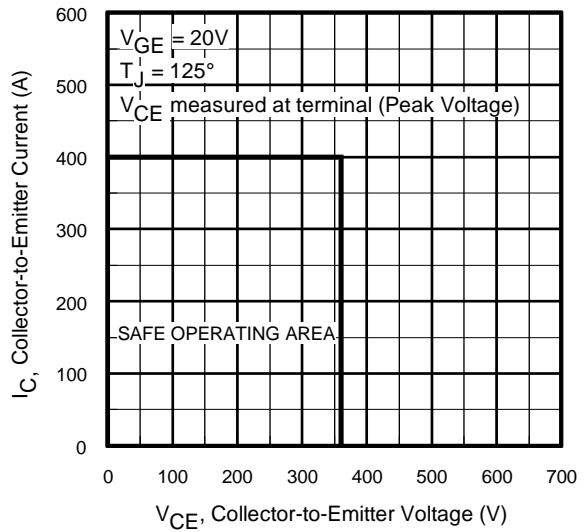

Fig. 11 - Reverse Bias SOA

GA200NS61U

International
IR Rectifier

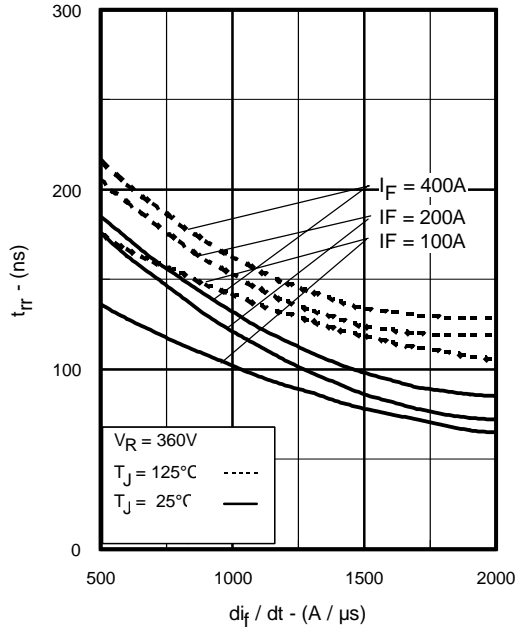

Fig. 12 - Typical Reverse Recovery vs. di_f/dt

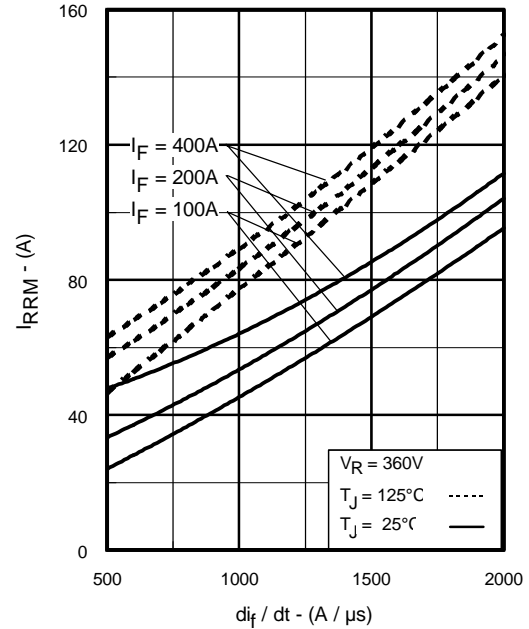

Fig. 13 - Typical Recovery Current vs. di_f/dt

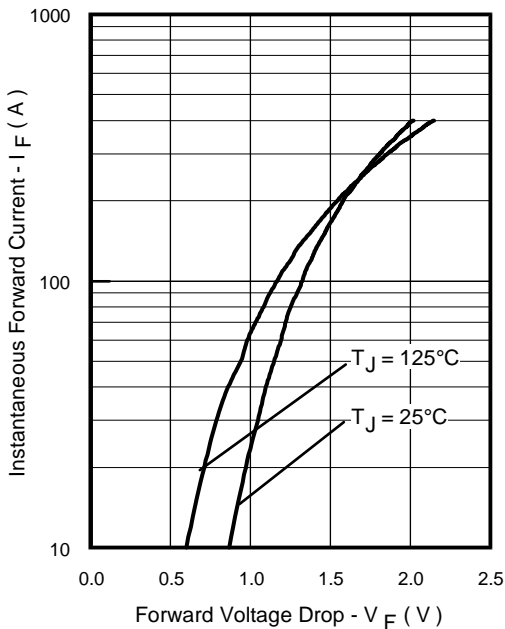

Fig. 14 - Typical Forward Voltage Drop vs. Instantaneous Forward Current

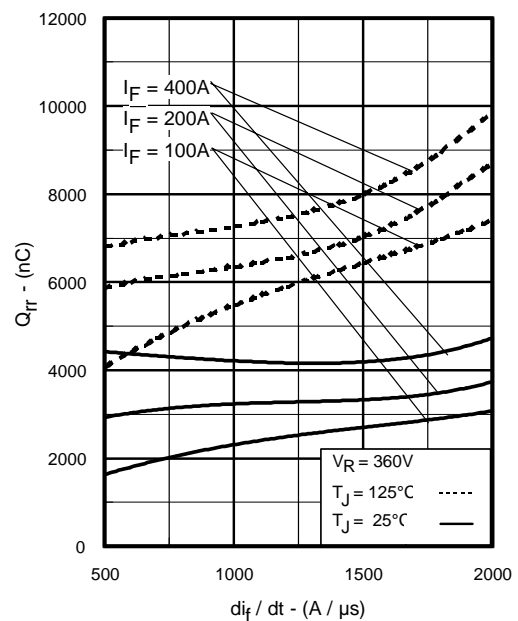
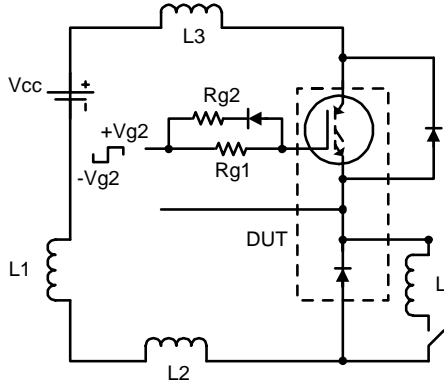

Fig. 15 - Typical Stored Charge vs. di_f/dt



$V_{cc} = 60\%$ of BV_{ces}
 $L_s = L1 + L2 + L3$
 $V_{ge} = 15V$

Fig. 16a - Test Circuit for Measurement of I_{LM} , E_{on} , $E_{off(diode)}$, t_{rr} , Q_{rr} , I_{rr} , $t_{d(on)}$, t_r , $t_{d(off)}$, t_f

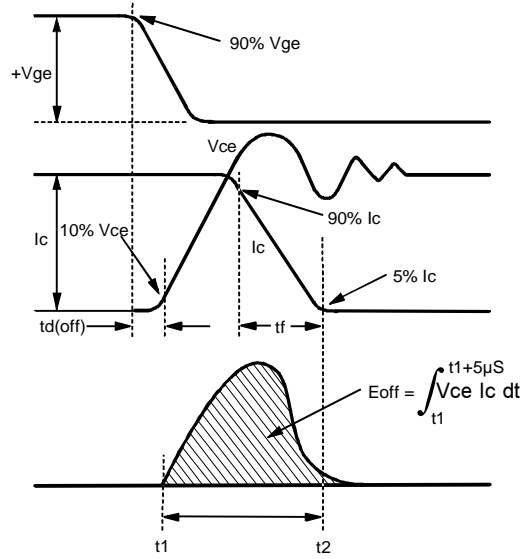

Fig. 16b - Test Waveforms for Circuit of Fig. 16a, Defining E_{off} , $t_{d(off)}$, t_f

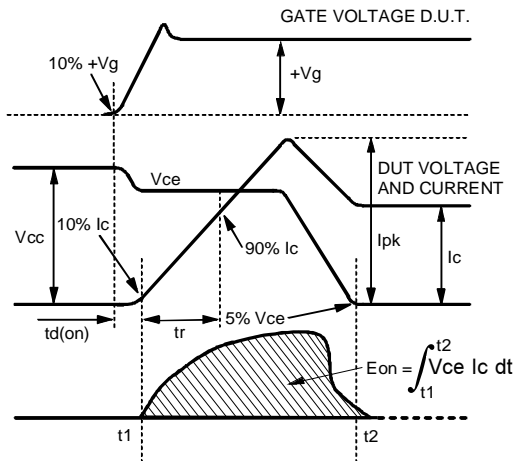

Fig. 16c - Test Waveforms for Circuit of Fig. 16a, Defining E_{on} , $t_{d(on)}$, t_r

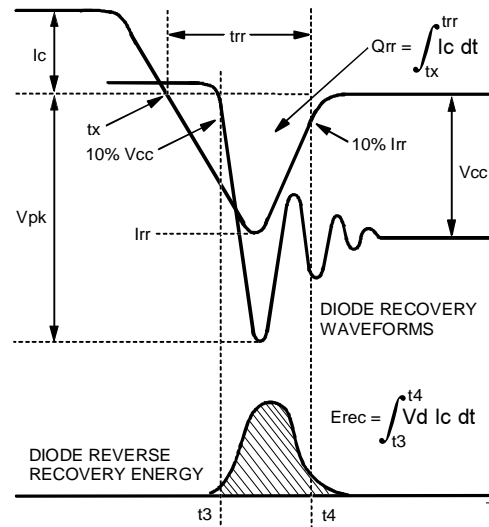

Fig. 16d - Test Waveforms for Circuit of Fig. 16a, Defining E_{rec} , t_{rr} , Q_{rr} , I_{rr}

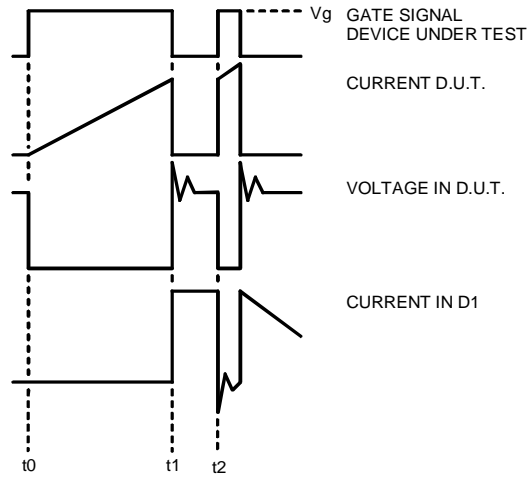

Figure 16e. Macro Waveforms for Figure 18a's Test Circuit

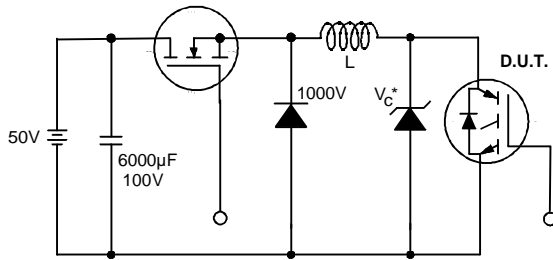

Figure 17. Clamped Inductive Load Test Circuit

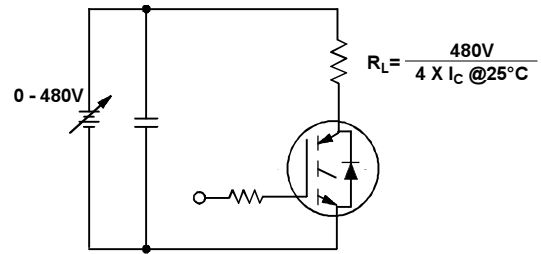
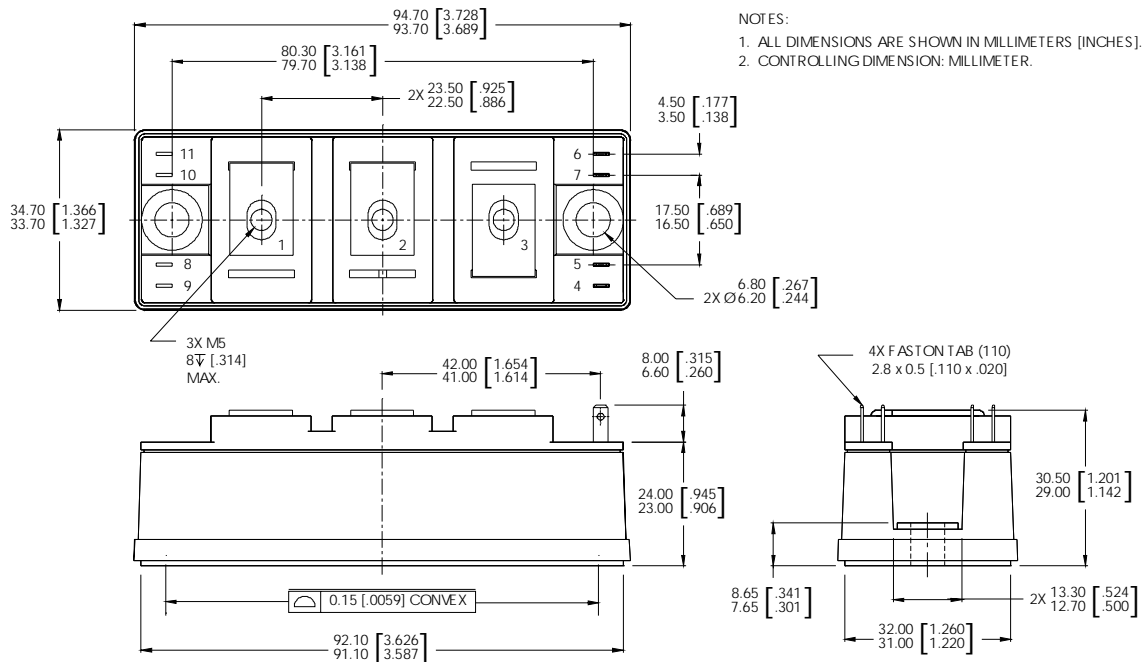

Figure 18. Pulsed Collector Current Test Circuit

Notes:

- ① Repetitive rating; $V_{GE} = 20V$, pulse width limited by max. junction temperature.
- ② See fig. 16
- ③ For screws M5x0.8
- ④ Pulse width 50 μ s; single shot.

Case Outline — INT-A-PAK



Data and specifications subject to change without notice.
 This product has been designed and qualified for the Industrial market.
 Qualification Standards can be found on IR's Web site.