

ULTRA LOW CAPACITANCE TVS ARRAY



DESCRIPTION

The GBLCxx and GBLCxxC Series are ultra low capacitance transient voltage suppressor arrays, designed to protect applications such as portable electronics and SMART phones. This series is available in both unidirectional and bidirectional configurations and is rated at 350 Watts for an 8/20 μ s waveshape.

The GBLCxx and GBLCxxC Series meets IEC 61000-4-2 (ESD) and IEC 61000-4-4 (EFT) requirements. At higher operating frequencies or faster edge rates, insertion loss and signal integrity are a major concern. This series offers a ultra low capacitance and low leakage current in a miniature SOD-323 package.

FEATURES

- Compatible with IEC 61000-4-2 (ESD): Air - 15kV, Contact - 8kV
Exceeds Level 4: Handles 10kV Contact & 25kV Air Discharge
- Compatible with IEC 61000-4-4 (EFT): 40A - 5/50ns
- Compatible with IEC 61000-4-5 (Surge)
- 350 Watts Peak Pulse Power per Line (tp = 8/20 μ s)
- Replacement for MLV (0805)
- Unidirectional & Bidirectional Configuration
- Protects One Power or I/O Port
- ESD Protection > 25kV
- Low Clamping Voltage
- Available in Multiple Voltages Ranging From 3V to 24V
- Ultra Low Capacitance: 3pF (Typical)
- RoHS Compliant
- REACH Compliant

APPLICATIONS

- Ethernet 10/100/1000 Base T
- SMART Phones
- Handheld - Wireless Systems
- USB Interface

MECHANICAL CHARACTERISTICS

- Molded JEDEC SOD-323 Package
- Approximate Weight: 5 milligrams
- Lead-Free Pure-Tin Plating (Annealed)
- Solder Reflow Temperature:
Pure-Tin - Sn, 100: 260-270°C
- 8mm Tape and Reel Per EIA Standard 481
- Flammability Rating UL 94V-0

PIN CONFIGURATIONS

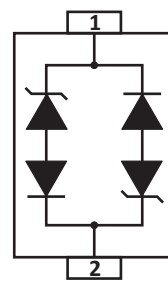
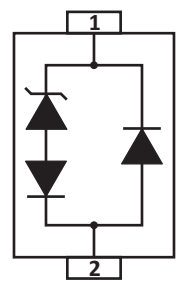

TYPICAL DEVICE CHARACTERISTICS
MAXIMUM RATINGS @ 25°C Unless Otherwise Specified

PARAMETER	SYMBOL	VALUE	UNITS
Peak Pulse Power (tp = 8/20μs) - See Figure 1	P _{PP}	350	Watts
Operating Temperature	T _A	-55 to 150	°C
Storage Temperature	T _{STG}	-55 to 150	°C

ELECTRICAL CHARACTERISTICS PER LINE @ 25°C Unless Otherwise Specified

PART NUMBER (Note 1 -2)	DEVICE MARKING	RATED STAND-OFF VOLTAGE	MINIMUM BREAKDOWN VOLTAGE	MAXIMUM CLAMPING VOLTAGE (Fig. 2)	MAXIMUM LEAKAGE CURRENT	TYPICAL CAPACITANCE
		V _{WM} VOLTS	@ 1mA V _(BR) VOLTS	@ IP = 1A V _C VOLTS	@ V _{WM} I _D μA	@ 0V, 1MHz C pF
GBLC03	3	3.3	4.0	7.0	5	3
GBLC03C	3C	3.3	4.0	7.0	5	3
GBLC05	5	5.0	6.0	9.8	5	3
GBLC05C	5C	5.0	6.0	9.8	5	3
GBLC08	8	8.0	8.5	13.4	2	3
GBLC08C	8C	8.0	8.5	13.4	2	3
GBLC12	2	12.0	13.3	19.0	1	3
GBLC12C	2C	12.0	13.3	19.0	1	3
GBLC15	6	15.0	16.7	24.0	1	3
GBLC15C	6C	15.0	16.7	24.0	1	3
GBLC18	1	18.0	20.0	29.0	1	3
GBLC18C	1C	18.0	20.0	29.0	1	3
GBLC24	4	24.0	26.7	43.0	1	3
GBLC24C	4C	24.0	26.7	43.0	1	3

NOTES

- Part numbers with an additional "C" suffix are bidirectional devices, i.e., GBLC05C.
- Unidirectional Only: Positive potential is applied from pin 1 to 2.

TYPICAL DEVICE CHARACTERISTICS

FIGURE 1
PEAK PULSE POWER VS PULSE TIME

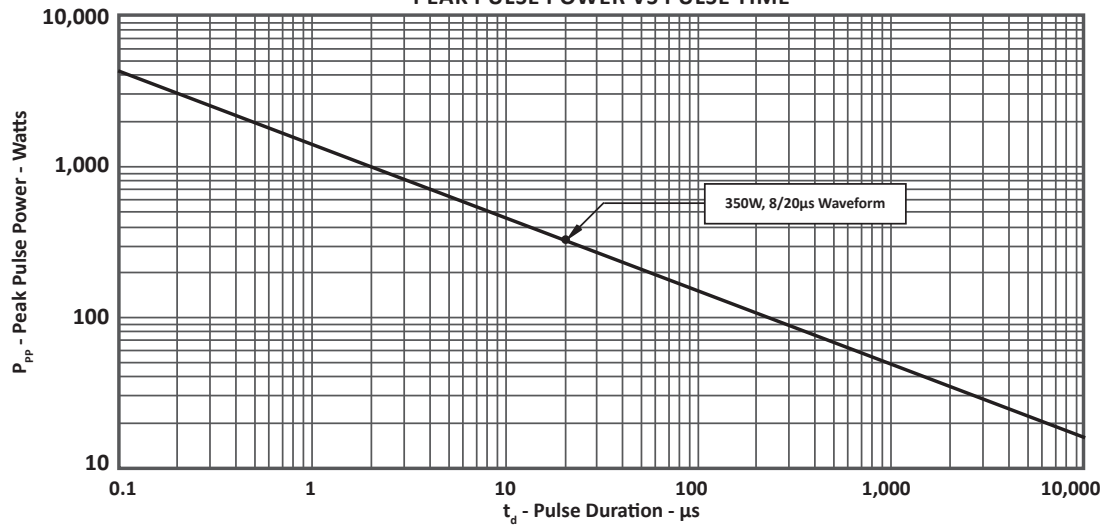
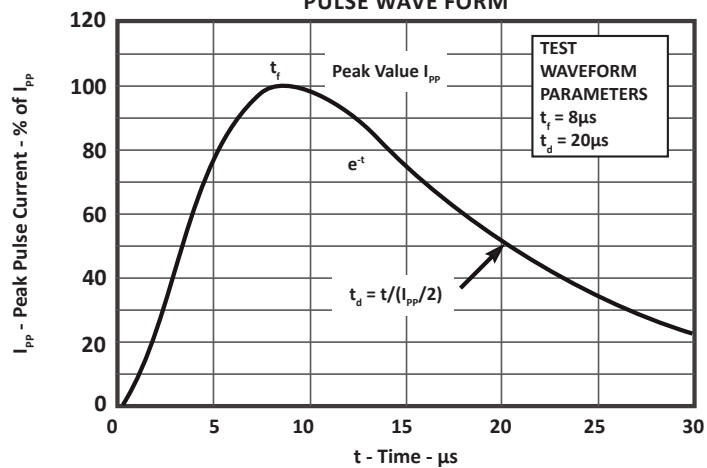
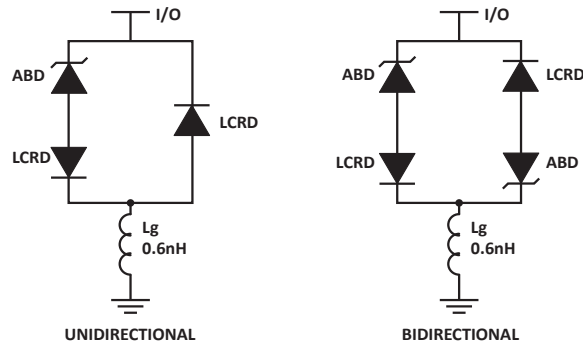

FIGURE 2
PULSE WAVE FORM



SPICE MODEL

FIGURE 1
SPICE MODEL

ABD - Avalanche Breakdown Diode (TVS)
 LCRD: Low Capacitance Rectifier Diode
 Lg - Lead Inductance

TABLE 1 - SPICE PARAMETERS

PARAMETER	UNIT	ABD(TVS)	LCRD
BV	V	See Table 2	200
IBV	μA	1	0.01
C _{jo}	pF	See Table 2	2
I _s	A	See Table 2	1E-11
Vj	V	0.6	0.6
M	-	0.33	0.33
N	-	1	1
R _s	Ohms	See Table 2	0.75
TT	s	1E-8	1E-9
EG	eV	1.11	1.11

TABLE 2 - ABD SPECIFIC SPICE PARAMETERS

PART NUMBER	B _v (VOLTS)	C _{jo} (pF)	I _s (AMPS)	Rs(OHMS)
GBLC03 & GBLC03C	4.0	438	1E-11	0.21
GBLC05 & GBLC05C	6.0	284	1E-11	0.14
GBLC08 & GBLC08C	8.5	146	1E-11	0.28
GBLC12 & GBLC12C	13.3	123	1E-13	0.40
GBLC15 & GBLC15C	16.7	102	1E-13	0.52
GBLC18 & GBLC18C	20.0	80	1E-13	0.80
GBLC24 & GBLC24C	26.7	61	1E-13	1.54

SOD-323 PACKAGE INFORMATION

OUTLINE DIMENSIONS

DIM	MILLIMETERS		INCHES	
	MIN	MAX	MIN	MAX
A	1.60	1.90	0.063	0.075
B	1.15	1.45	0.045	0.057
C	2.39	2.70	0.094	0.106
D	0.80	1.10	0.031	0.043
E	0.25	0.40	0.010	0.016
F	0.10	0.20	0.004	0.008
H	-	0.10	-	0.004
L	0.20	-	0.008	-

NOTES

- Controlling dimension: millimeters.
- Dimensioning and tolerances per ANSI Y14.5M, 1985.
- Dimensions are exclusive of mold flash and metal burrs.

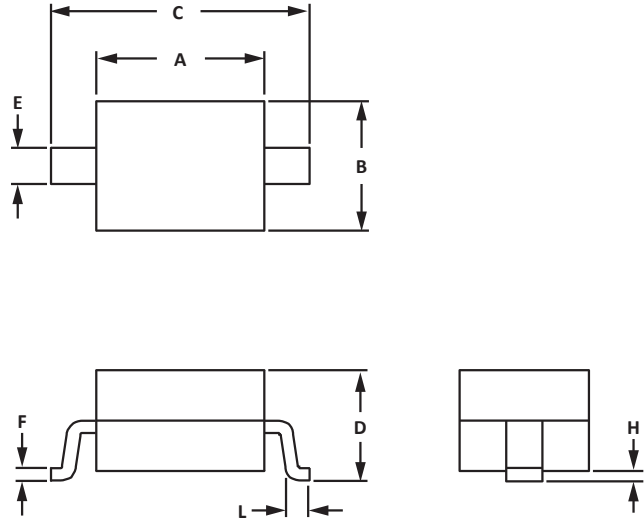

PAD LAYOUT DIMENSIONS

DIM	MILLIMETERS		INCHES	
	MIN	MAX	MIN	MAX
A	2.87	3.12	0.113	0.123
B	0.66	0.91	0.026	0.036
C	0.66	0.91	0.026	0.036

NOTES

- Controlling dimension: millimeters.

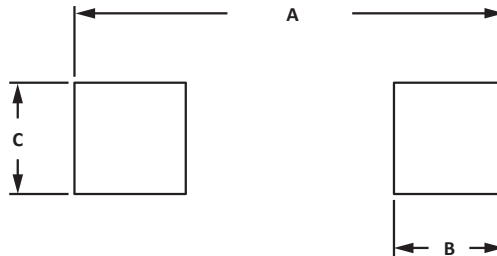

TAPE AND REEL

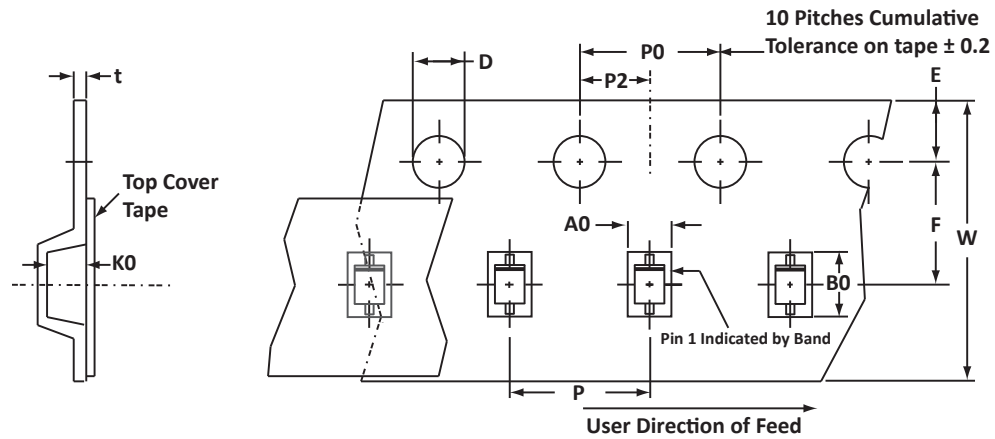

SPECIFICATIONS

REEL DIA.	TAPE WIDTH	A0	B0	K0	D	E	F	W	P0	P2	P	tmax
178mm (7")	8mm	1.55 ± 0.10	2.90 ± 0.10	1.35 ± 0.10	1.50 ± 0.10	1.75 ± 0.10	3.50 ± 0.05	8.00 ± 0.30	4.00 ± 0.10	2.00 ± 0.05	4.00 ± 0.10	0.25

NOTES

- Dimensions are in millimeters.
- Surface mount product is taped and reeled in accordance with EIA-481.
- Suffix - T7 = 7" Reel - 3,000 pieces per 8mm tape.
- Marking on Part - marking code (see page 2), polarity band (Unidirectional Only).

ORDERING INFORMATION

BASE PART NUMBER (xx = Voltage)	LEADFREE SUFFIX	TAPE SUFFIX	QTY/REEL	REEL SIZE	TUBE QTY
GBLCxx/GBLCxxC	-LF	-T7	3,000	7"	n/a

This device is only available in a Lead-Free configuration.

COMPANY INFORMATION

COMPANY PROFILE

In business more than 20 years, ProTek Devices™ is a privately held semiconductor company. The company offers a product line of overvoltage protection and overcurrent protection components. These include transient voltage suppressor array (TVS arrays) avalanche breakdown diode, steering diode TVS array and electronics SMD chip fuses. These components deliver circuit protection in electronic systems from numerous overvoltage and overcurrent events. They include lightning; electrostatic discharge (ESD); nuclear electromagnetic pulses (NEMP); inductive switching; and electromagnetic interference (EMI) / radio frequency interference (RFI). ProTek Devices also offers high performance interface and linear products. They include analog switches; multiplexers; LED drivers; LED wafer die for ESD protection; audio control ICs; RF and related high frequency products.

CONTACT US

Corporate Headquarters

2929 South Fair Lane
Tempe, Arizona 85282
USA

By Telephone

General: 602-431-8101
Sales: & Marketing: 602-414-5109
Customer Service: 602-414-5114
Product Technical Support: 602-414-5107

By Fax

General: 602-431-2288

By E-mail:

Asia Sales: asiasales@protekdevices.com
Europe Sales: europesales@protekdevices.com
U.S. Sales: ussales@protekdevices.com
Distributor Sales: distysales@protekdevices.com
Customer Service: service@protekdevices.com
Technical Support: support@protekdevices.com

ProTek Devices (Asia Pacific) Pte. Ltd.

8 Ubi Road 2, #06-19
Zervex
Singapore - 408538
Tel: +65-67488312
Fax: +65-67488313

Web

www.protekdevices.com

COPYRIGHT © ProTek Devices 2001 - This literature is subject to all applicable copyright laws and is not for resale in any manner.

SPECIFICATIONS: ProTek reserves the right to change the electrical and or mechanical characteristics described herein without notice.

DESIGN CHANGES: ProTek reserves the right to discontinue product lines without notice and that the final judgement concerning selection and specifications is the buyer's and that in furnishing engineering and technical assistance. ProTek assumes no responsibility with respect to the selection or specifications of such products. ProTek makes no warranty, representation or guarantee regarding the suitability of its products for any particular purpose, nor does ProTek assume any liability arising out of the application or use of any product or circuit and specifically disclaims any and all liability without limitation special, consequential or incidental damages.

LIFE SUPPORT POLICY: ProTek Devices products are not authorized for use in life support systems without written consent from the factory.