



# GBU6A thru GBU6M

Glass Passivated Single-Phase Bridge Rectifiers  
Reverse Voltage 50 to 1000 Volts Forward Current 6.0 Amperes

## Features

- ◆ Ideal for printed circuit boards
- ◆ High surge current capability
- ◆ High case dielectric strength of 1500 V<sub>RMS</sub>
- ◆ Solder Dip 260 °C, 40 seconds

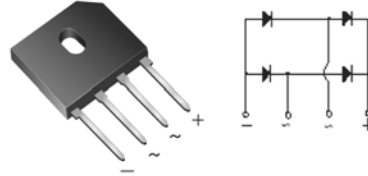

## Mechanical Data

- ◆ Case: GBU  
Epoxy meets UL-94V-0 Flammability rating
- ◆ Terminals: Matte tin plated (E3 Suffix) leads, solderable per J-STD-002B and JESD22-B102D
- ◆ Polarity: As marked on body
- ◆ Mounting Torque: 10 cm-kg (8.8 inches-lbs) max.
- ◆ Recommended Torque: 5.7 cm-kg (5 inches-lbs)

## Typical Applications

General purpose use in ac-to-dc bridge full wave rectification for Monitor, TV, Printer, Switching Mode Power Supply, Adapter, Audio equipment, and Home Appliances applications.

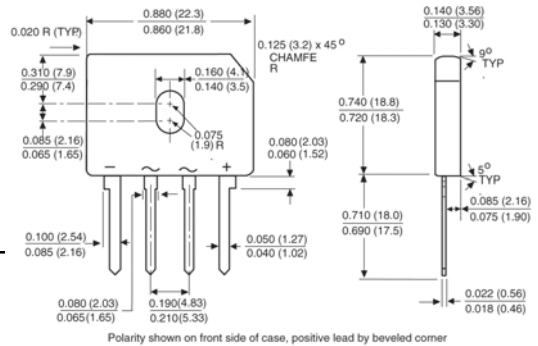

## Maximum Ratings and Electrical Characteristics

T<sub>A</sub> = 25 °C, unless otherwise specified.

Parameter	Symbols	GBU6A	GBU6B	GBU6D	GBU6G	GBU6J	GBU6K	GBU6M	Units
Maximum repetitive peak reverse voltage	V <sub>RRM</sub>	50	100	200	400	600	800	1000	Volts
Maximum RMS voltage	V <sub>RMS</sub>	35	70	140	280	420	560	700	Volts
Maximum DC blocking voltage	V <sub>DC</sub>	50	100	200	400	600	800	1000	Volts
Maximum average forward rectified output current at (Fig.1)	I <sub>F(AV)</sub>				6.0				Amps
					3.0				
Peak forward surge current, 8.3ms single half sine-wave superimposed on rated load (JEDEC Method)	I <sub>FSM</sub>				175.0				Amps
Rating for fusing (t<8.3ms)	I <sub>t</sub>				127				A <sup>2</sup> sec
Maximum instantaneous forward voltage drop per leg at 3.0A	V <sub>F</sub>				1.0				Volt
Maximum DC reverse current at rated DC blocking voltage per leg	I <sub>R</sub>				5.0				uA
					500.0				
Typical junction capacitance per leg at 4.0V, 1MHz	C <sub>J</sub>				211				pF
Typical thermal resistance per leg	R <sub>θJA</sub> <sup>(2)</sup> R <sub>θJC</sub> <sup>(1,3)</sup>				20				°C/W
					2.5				
Operating junction and storage temperature range	T <sub>J</sub> , T <sub>STG</sub>				-55 to +150				°C

- Notes:**
1. Units case mounted on 11x11x0.15cm thick Al plate heatsink
  2. Units mounted in free air, no heatsink on P.C.B., 0.5 x 0.5" (13 x 13 mm) copper pads, 0.375" (9.5 mm) lead length
  3. Recommended mounting position is to bolt down on heatsink with silicone thermal compound for maximum heat transfer with #6 screws

# RATINGS AND CHARACTERISTIC CURVES

( $T_A = 25^\circ\text{C}$  unless otherwise noted)

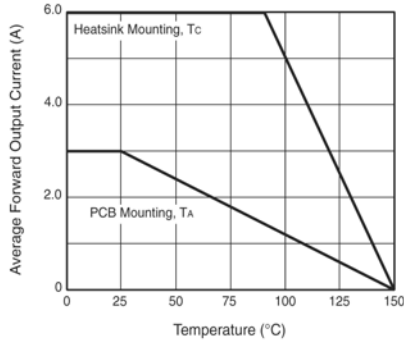

Figure 1. Derating Curve Output Rectified Current

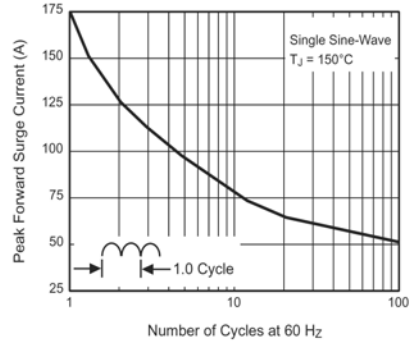

Figure 2. Maximum Non-Repetitive Peak Forward Surge Current Per Leg

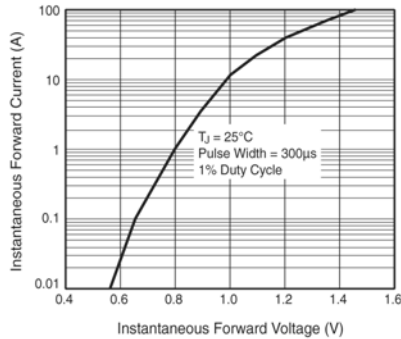

Figure 3. Typical Forward Characteristics Per Leg

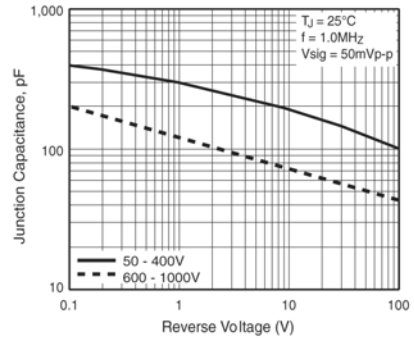

Figure 5. Typical Junction Capacitance Per Leg

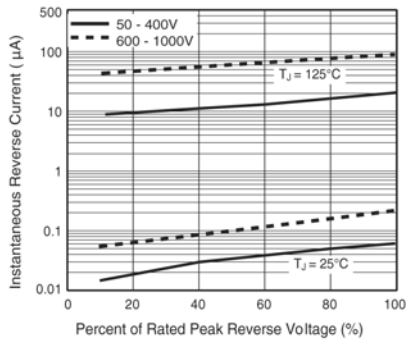

Figure 4. Typical Reverse Leakage Characteristics Per Leg

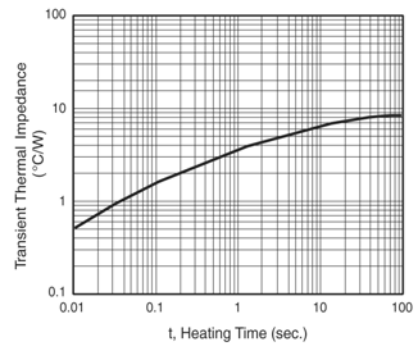

Figure 6. Typical Transient Thermal Impedance