



1/5" UXGA CMOS Image Sensor
GC2035

DataSheet
V1.0

2012-09-18

GalaxyCore Inc.

Content

1. SENSOR OVERVIEW	4
1.1 GENERAL DESCRIPTION	4
1.2 FEATURES	4
1.3 APPLICATION	5
1.4 TECHNICAL SPECIFICATIONS	5
2. BLOCK DIAGRAM	6
2.1 BLOCK DIAGRAM	6
2.2 SIGNAL DESCRIPTIONS	7
2.3 PIN DIAGRAM	8
3. OPTICAL SPECIFICATIONS	9
3.1 SENSOR ARRAY CENTER	9
3.2 PIXEL ARRAY	10
3.3 LENS CHIEF RAY ANGLE (CRA)	11
3.4 COLOR FILTER SPECTRAL CHARACTERISTICS	12
4. TWO-WIRE SERIAL BUS COMMUNICATION	12
4.1 PROTOCOL	12
4.2 SERIAL BUS TIMING	13
5. APPLICATIONS	14
5.1 TIMING DVP	14
5.2 MIPI	15
5.2.1 Clock lane low-power	15
5.2.2 Data Burst	16

5.3	POWER ON/OFF SEQUENCE	17
5.3.1	<i>Power On Sequence</i>	17
5.3.2	<i>Power Off Sequence</i>	17
5.4	DC PARAMETERS	17
6.	PACKAGE SPECIFICATIONS	18
7.	REGISTER LIST	19
7.1	SYSTEM REGISTER	19
7.2	ANALOG & CISCTL	21
7.3	ISP RELATED	25

1. Sensor Overview

1.1 General Description

GC2035 is a high quality 2Mega CMOS image sensor, for mobile phone camera applications and digital camera products. GC2035 incorporates a 1616V x 1232H pixel array, on-chip 10-bit ADC, and image signal processor.

The on-chip ISP provides a very smooth AE (Auto Exposure) and accurate AWB (Auto White Balance) control. It provides various data formats, such as Bayer RGB, RGB565, YCbCr 4:2:2. It has a commonly used two-wire serial interface for host to control the operation of the whole sensor.

Internal master clock can be generated by on-chip Phase Lock Loop(PLL) oscillator.

1.2 Features

- ◆ Standard optical format of 1/5 inch
- ◆ Various output formats: YCbCr4:2:2, RGB565, Raw Bayer
- ◆ PLL support
- ◆ Windowing support
- ◆ MIPI interface support
- ◆ Horizontal /Vertical mirror
- ◆ Image processing module
- ◆ Package: CSP/wafer

1.3 Application

- ◆ Cellular Phone Cameras
- ◆ Notebook and desktop PC cameras
- ◆ PDAs
- ◆ Toys
- ◆ Digital still cameras and camcorders
- ◆ Video telephony and conferencing equipment
- ◆ Security systems
- ◆ Industrial and environmental systems

1.4 Technical Specifications

Parameter	Typical value
Optical Format	1/5 inch
Pixel Size	1.75um x 1.75um
Active pixel array	1616 x 1232
ADC resolution	10 bit ADC
Shutter type	Electronic rolling shutter
Max Frame rate	15fps@24Mhz, UXGA ~30fps@24Mhz, SVGA
Power Supply	AVDD28: 2.7~3.0V DVDD18: 1.7~1.9V IOVDD: 1.7~3.0V
Power Consumption	180mW(Active) <100uA(Standby)
SNR	TBD
Dark Current	TBD
Sensitivity	TBD
Operating temperature:	-20~70°C
Stable Image temperature	0~50°C
Optimal lens chief ray angle(CRA)	25° (non-linear)
Package type	CSP/wafer

2. Block Diagram

2.1 Block Diagram

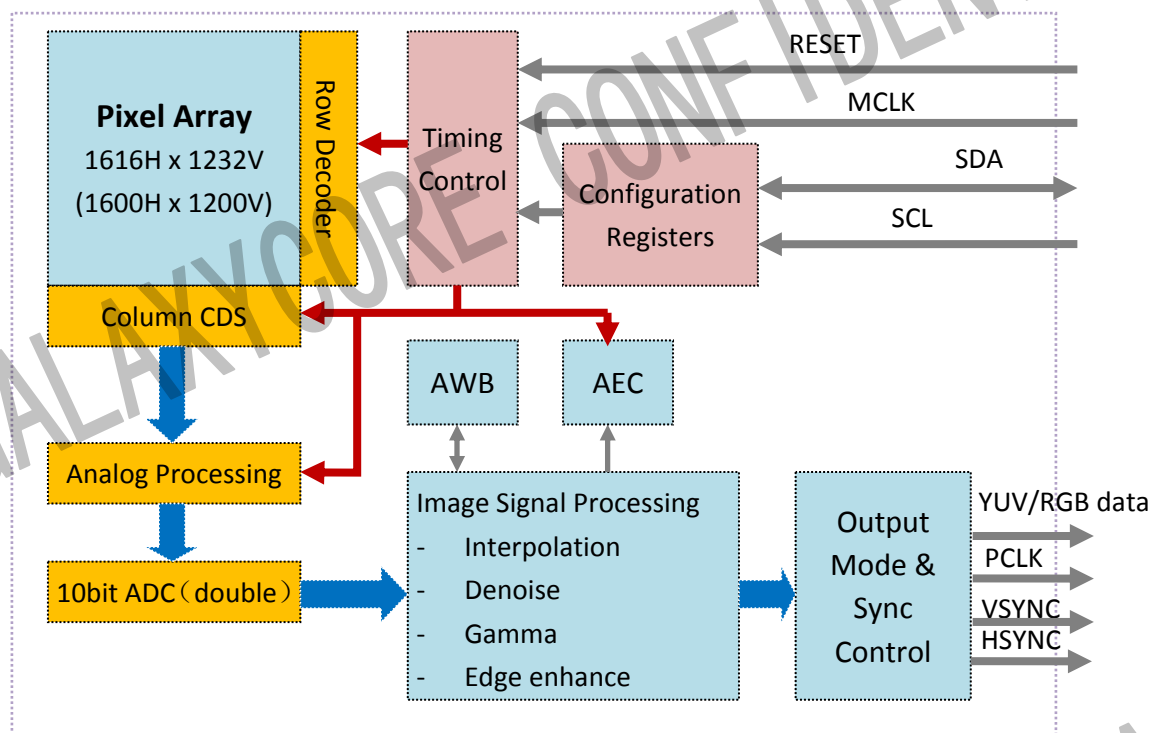

GC2035 has an active image array of 1616 x 1232 pixels. The active pixels are read out progressively through column/row driver circuits. In order to reduce fixed pattern noise, CDS circuits are adopted. The analog signal is transferred to digital signal by 10 bit A/D converter. The digital signals are processed in the ISP Block, including Bayer interpolation, de-noise, and color correction, gamma correction, and data format conversion and so on. Users can easily control these functions via two-wire serial interface bus.

2.2 Signal Descriptions

	Name	Pin type	Description
A1	AVDD28	Power	Power for analog circuit/sensor array
A2	PWDN	Input	power down (active high)
A3	SBCL	Input	SCCB input clock
A4	VSYNC	Output	Vertical reference output
A5	PCLK	Output	Pixel clock output
A6	IOVDD	Power	Power Supply for I/O circuits
B1	AGND	Ground	Ground for analog circuit/sensor array
B2	RESETB	Input	reset (active Low)
B3	SBDA	I/O	SCCB data
B4	HSYNC	Output	Horizontal sync output
B5	DVDD18	Power	Power for digital core
B6	D<0>	Output	YUV/RGB video port bit [0]
C1	VPIX	Power	Internal analog power
C2	TXLOW	Power	internal analog reference
C3	NC		
C4	DGND	Ground	Ground for digital circuit
C5	D<1>	Output	YUV/RGB video port bit [1]
C6	D<2>	Output	YUV/RGB video port bit [2]
D1	CGND	Ground	Ground for analog circuit
D2	AGND	Ground	Ground for analog circuit/sensor array
D3	DVDD18	Power	Power for digital core
D4	DGND	Ground	Ground for digital circuit
D5	D<4>	Output	YUV/RGB video port bit [4]
D6	D<3>	Output	YUV/RGB video port bit [3]
E1	AVDD28	Power	Power for analog circuit/sensor array

E2	MDP<0>	Output	MIPI Data<0> (+)
E3	MDN<1>	Output	MIPI Data<1> (-)
E4	MCP	Output	MIPI clock (+)
E5	D<6>	Output	YUV/RGB video port bit [6]
E6	D<5>	Output	YUV/RGB video port bit [5]
F1	INCLK	Input	Sensor master input clock
F2	MDN<0>	Output	MIPI Data<0> (-)
F3	MDP<1>	Output	MIPI Data<1> (+)
F4	MCN	Output	MIPI clock (-)
F5	D<7>	Output	YUV/RGB video port bit [7]
F6	DVDD18 & MVDD	Power	Power for digital core Power for MIPI

2.3 Pin Diagram

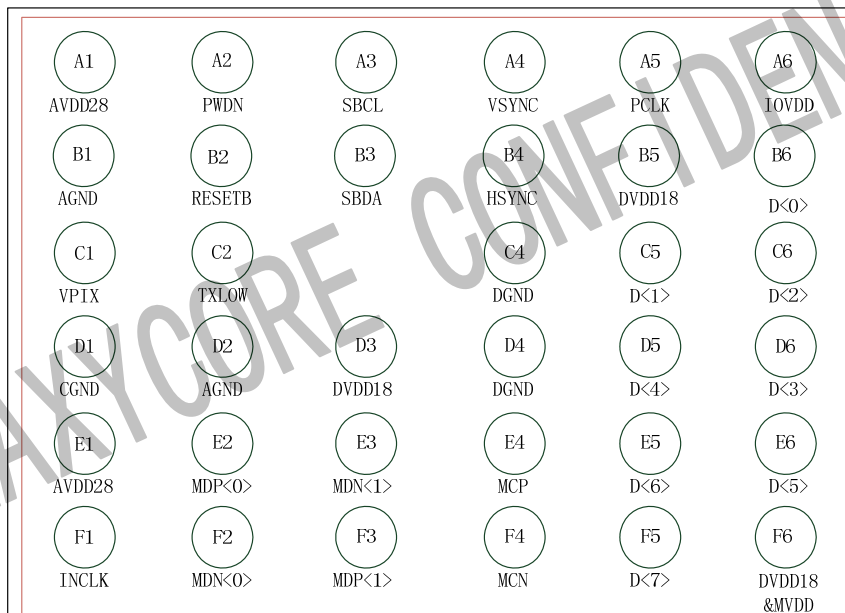

Top View

3. Optical Specifications

3.1 Sensor Array Center

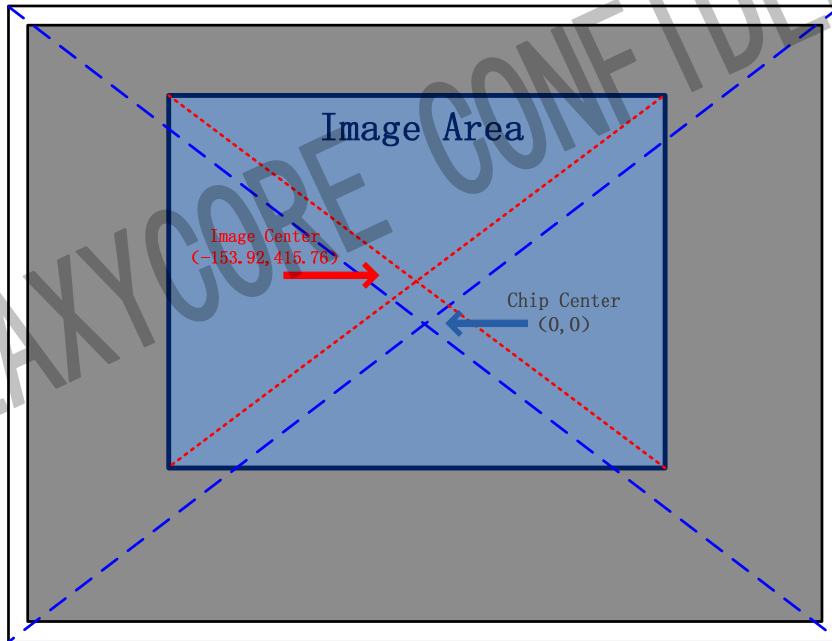

Top View

3.2 Pixel Array

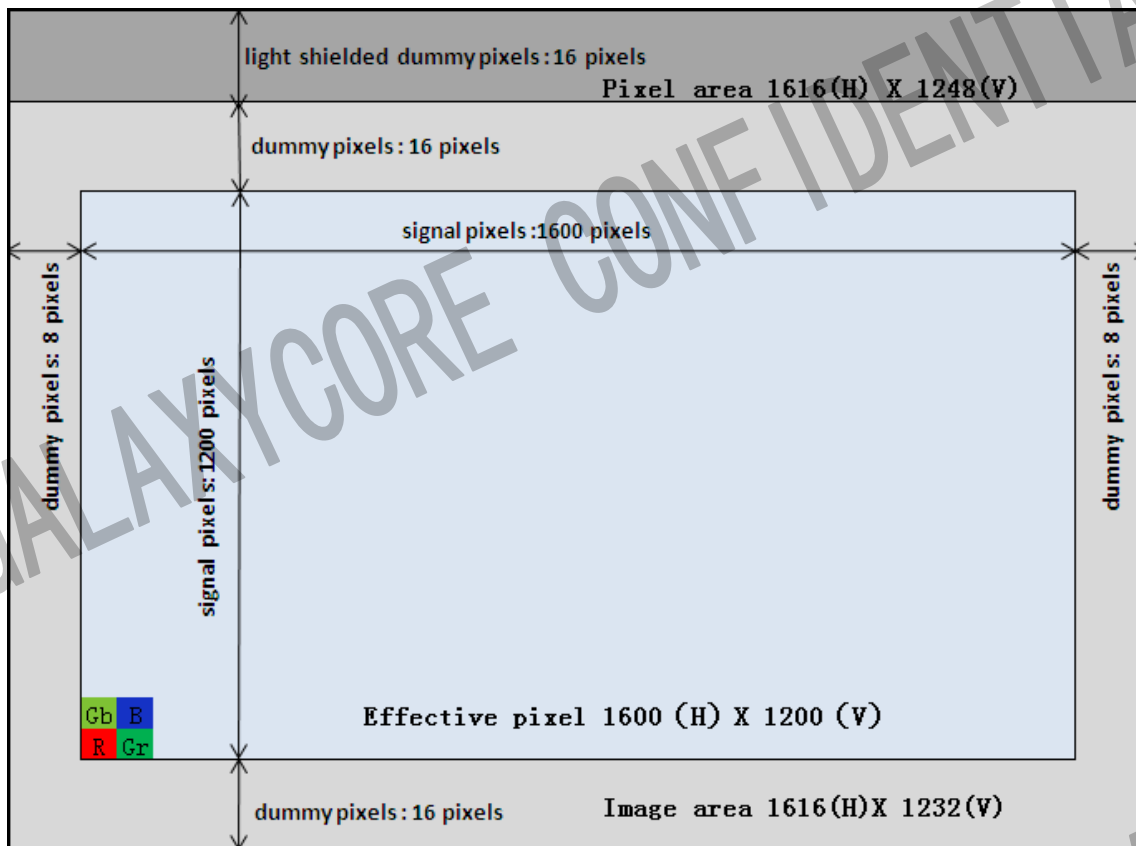

Pixel array is covered by Bayer pattern color filters. The primary color BG/GR array is arranged in line-alternating way.

If no flip in column, column is read out from 0 to 1615. If flip in column, column is read out from 1615 to 0.

If no flip in row, row is read out from 0 to 1231. If flip in row, row is read out from 1231 to 0.

3.3 Lens Chief Ray Angle (CRA)

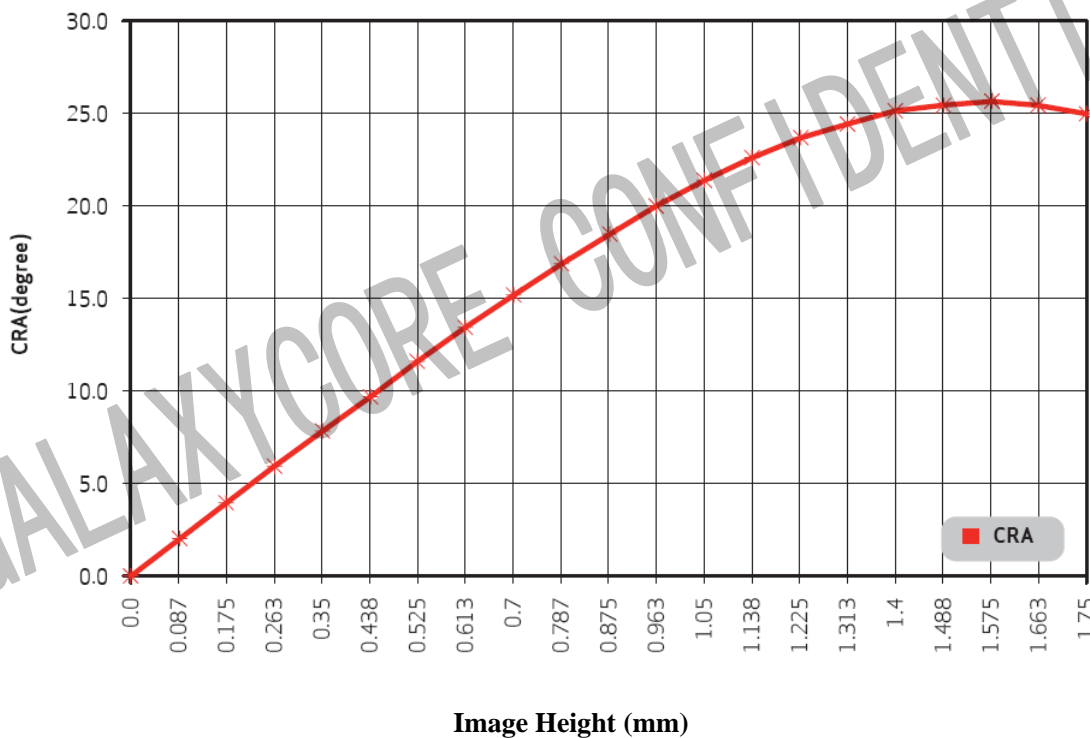

Field (%)	Image height(mm)	CRA(degrees)
0	0	0
10	0.177	4.15
20	0.354	8.25
30	0.531	12.2
40	0.708	15.83
50	0.885	18.98
60	1.062	21.61
70	1.239	23.62
80	1.416	24.82
90	1.593	25.39
100	1.77	25.78
110	1.895	25.89

3.4 Color Filter Spectral Characteristics

The optical spectrum of color filters is shown as follows:

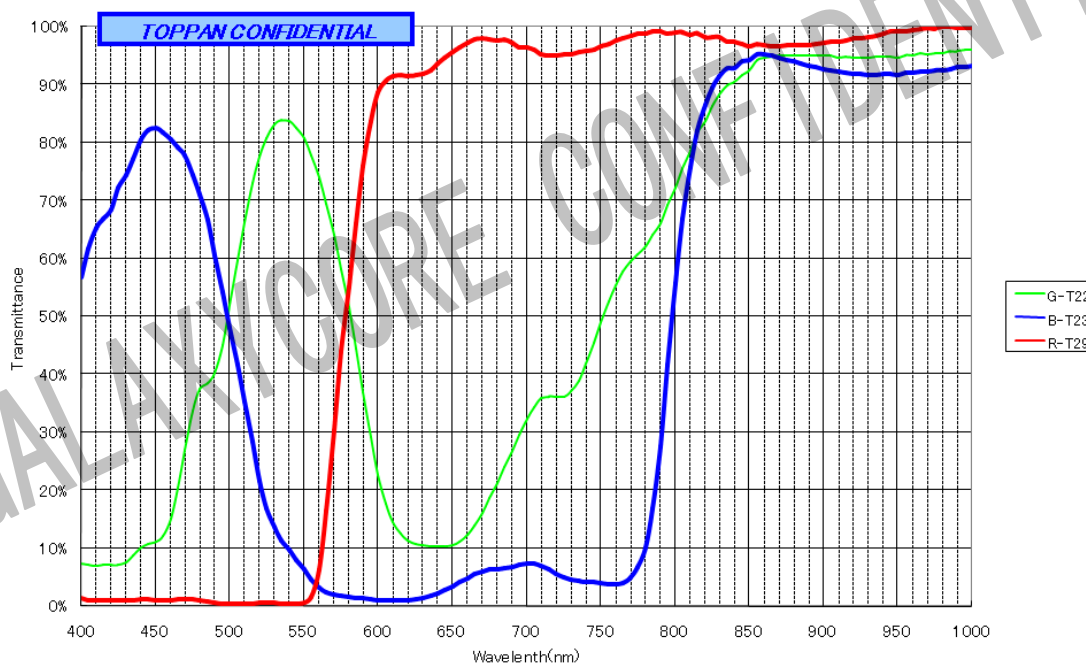

4. Two-wire Serial Bus Communication

GC2035 Device Address:

serial bus write address = 0x78, serial bus read address = 0x79

4.1 Protocol

The host must perform the role of a communications master and GC2035 acts as either a slave receiver or transmitter. The master must do:

- ◆ Generate the **Start(S)/Stop(P)** condition
- ◆ Provide the serial clock on **SBCL**

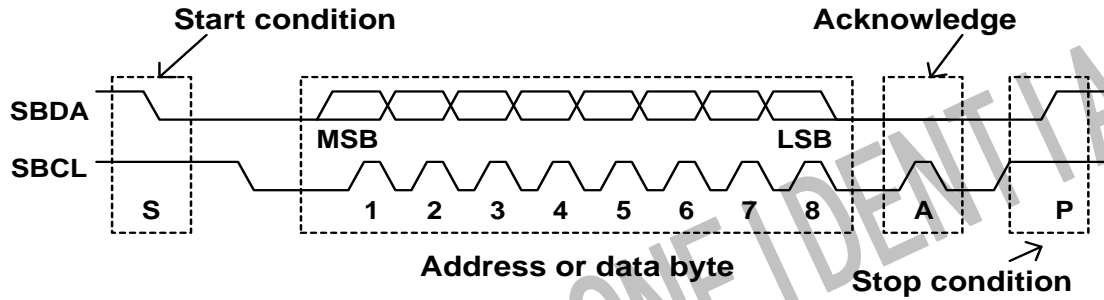

Single Register Writing:

S	78H	A	Register Address	A	Data	A	P
---	-----	---	------------------	---	------	---	---

Incremental Register Writing:

S	78H	A	Register Address	A	Data(1)	A	Data(N)	A	P
---	-----	---	------------------	---	---------	---	-------	---------	---	---

Single Register Reading:

S	78H	A	Register Address	A	S	79H	A	Data	NA	P
---	-----	---	------------------	---	---	-----	---	------	----	---

Notes:

From master to slave

From slave to master

S: Start condition

P: Stop condition

A: Acknowledge bit

NA: No acknowledge

Register Address: Sensor register address

Data: Sensor register value

4.2 Serial Bus Timing

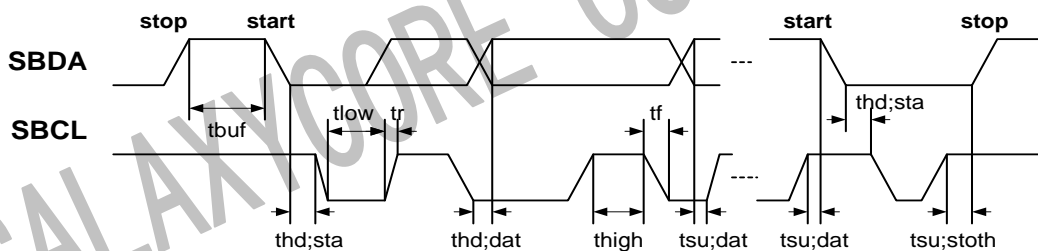

Parameter	Symbol	Min.	Max.	Unit
SBCL clock frequency	fscl	0	400	KHz
Bus free time between a stop and a start	tbuf	1.2	*	µs
Hold time for a repeated start	thd;sta	1.0	*	µs
LOW period of SBCL	tlow	1.2	*	µs

HIGH period of SBCL	thigh	1.0	*	μs
Set-up time for a repeated start	tsu;sta	1.2	*	ns
Data hold time	thd;dat	1.3	*	ns
Data Set-up time	tsu;dat	250	*	ns
Rise time of SBCL, SBDA	tr	*	250	ns
Fall time of SBCL, SBDA	tf	*	300	ns
Set-up time for a stop	tsu;sto	1.2	*	μs
Capacitive load of bus line (SBCL, SBDA)	Cb	*	*	pf

5. Applications

5.1 Timing DVP

Supposed Vsync is low active and Hsync is high active, and output format is YCbCr/RGB565, then the timing of Vsync and Hsync is following:

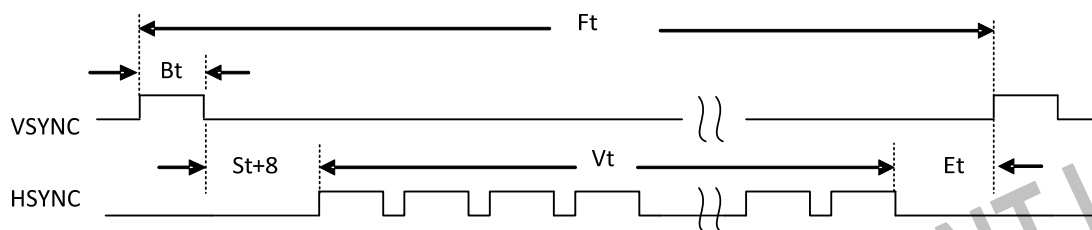

$$Ft = VB + Vt + 8 \text{ (unit is row_time)}$$

$VB = Bt + St + Et$, Vblank/Dummy line, setting by register 0x07 and 0x08.

- ◆ Ft -> Frame time, one frame time.
- ◆ Bt -> Blank time, Vsync no active time.
- ◆ St -> Start time, setting by register 0x13
- ◆ Et -> End time, setting by register 0x14
- ◆ Vt -> valid line time. UXGA is 1200, $Vt = \text{win_height} - 8$, win_height is setting by register 0x0d and 0x0e(1232).

When $\text{exp_time} \leq \text{win_height} + VB$, $Bt = VB - St - Et$. Frame rate is controlled by $\text{window_height} + VB$.

When $\text{exp_time} > \text{win_height} + VB$, $Bt = \text{exp_time} - \text{win_height} - St - Et$. Frame rate is controlled by exp_time .

The following is row_time calculate:

$$\text{row_time} = \text{Hb} + \text{Sh_delay} + \text{win_width} + 4.$$

Hb -> HBlank or dummy pixel, Setting by register 0x05 and 0x06.

Sh_delay -> Setting by register 0x11.

win_width -> Setting by register 0x0f and 0x10, win_width = 1600, final_output_width + 8. So for UXGA, we should set win_width as 1616.

5.2 MIPI

5.2.1 Clock lane low-power

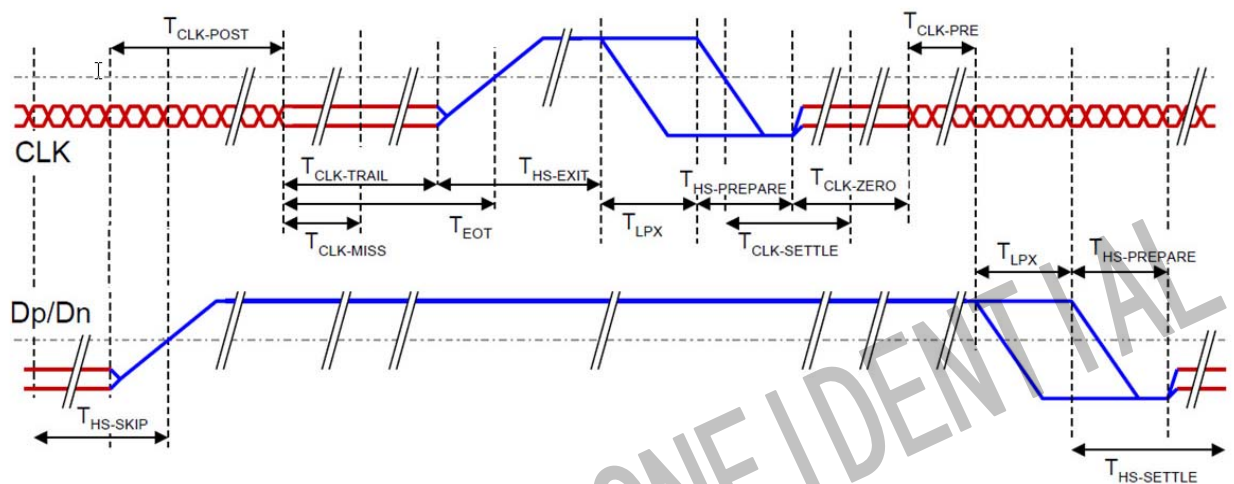

Notice:

- ◆ Clock must be reliable during high speed transmission and mode-switching
- ◆ Clock can go to LP only if data lanes are in LP (and nothing relies on it),
- ◆ In Low -Power data lanes are conceptually asynchronous (independent of the high speed clock)

$T_{\text{CLK_PRE}}$: setting by Register P3: 0x24

$T_{\text{CLK_POST}}$: setting by Register P3: 0x25

$T_{\text{CLK_ZERO}}$: setting by Register P3: 0x23

$T_{\text{CLK_TRAIL}}$: setting by Register P3: 0x26

5.2.2 Data Burst

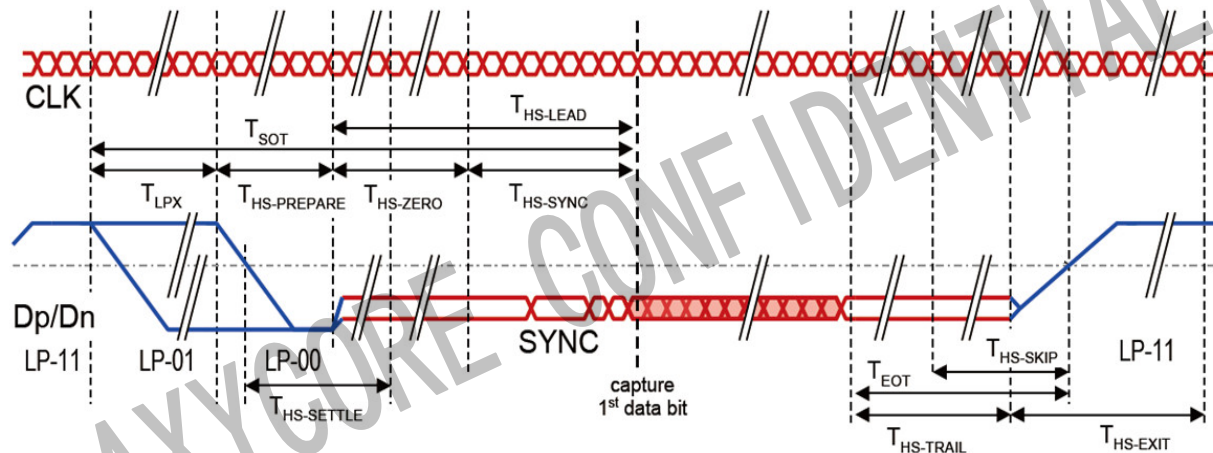

Notice:

- ◆ Clock Keeps running and samples data lanes(except for lanes in LPS)
- ◆ Unambiguous leader and trailer sequences required to distill real ditz,
- ◆ trailer is removed inside PHY(a few bytes)
- ◆ Time-out to ignore line values during line state transition

T_{LPX} : setting by Register P3:0x21

$T_{HS-PREPARE}$: setting by Register P3: 0x29

$T_{HS-ZERO}$: setting by Register P3:0x2a

$T_{HS-TRAIL}$: setting by Register P3:0x2b

$T_{HS-EXIT}$: setting by Register P3: 0x27

5.3 Power On/Off Sequence

5.3.1 Power On Sequence

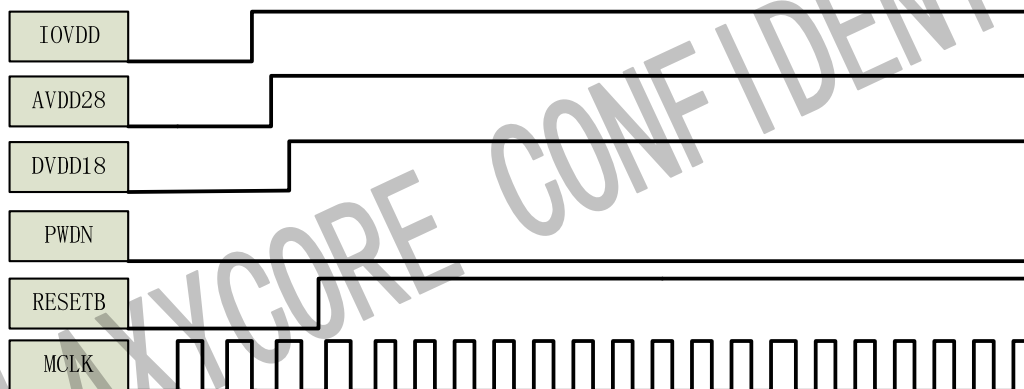

5.3.2 Power Off Sequence

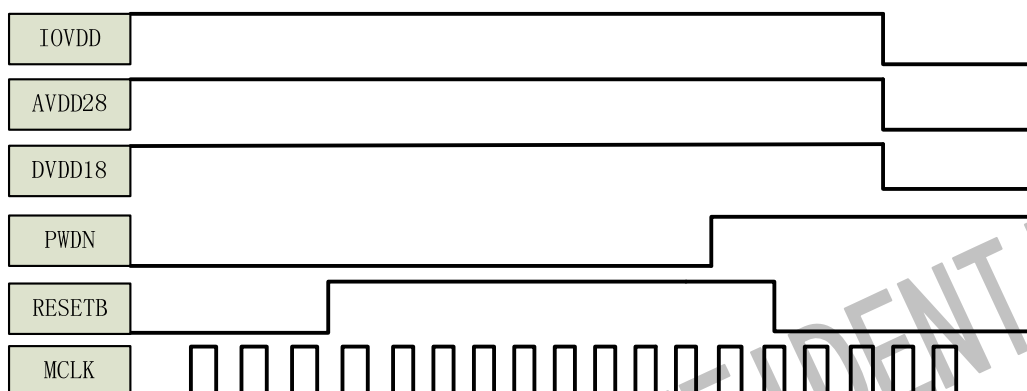

5.4 DC Parameters

Symbol	Parameter	Min	Typ	Max	Unit	
Supply						
V_{AVDD28}	Power supply	2.7	2.8	3.0	V	
V_{DVDD18}	Supply voltage(digital core)	1.7	1.8	1.9	V	
V_{IOVDD}	Supply voltage(digital I/O)	1.7	1.8	3.0	V	
I_{AVDD28}	Active(operating) current		30	50	mA	
I_{DVDD18}			20	100	mA	
I_{IOVDD}		1.8V		10	10	mA
		2.8V		15	10	mA

I_{DDSPWD}	Standby Current	30	60	100	uA
Digital Input(Typical conditions: AVDD28 = 2.8V, DVDD = 1.8V, IOVDD = 1.8V)					
V_{IH}	Input voltage HIGH	1.9			V
V_{IL}	Input voltage LOW			0.5	V
Digital Output(AVDD28 = 2.8V, standard Loading 25PF, IOVDD = 1.8V)					
V_{OH}	Output voltage HIGH	2.5			V
V_{OL}	Output voltage LOW			0.2	V

6. Package Specifications

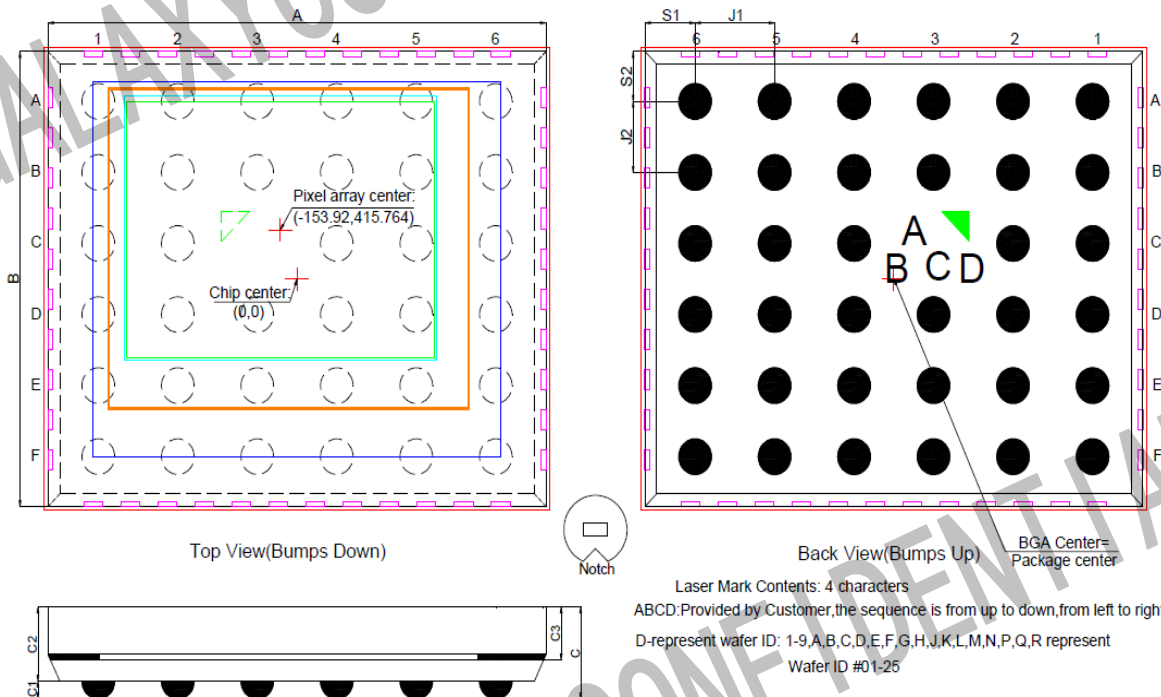

Description	Symbol	Nominal	Min.	Max.
		Millimeters		
Package Body Dimension X	A	4.570	4.545	4.595
Package Body Dimension Y	B	3.840	3.815	3.865
Package Height	C	0.780	0.720	0.840
Ball Height	C1	0.160	0.130	0.190
Package Body Thickness	C2	0.620	0.585	0.655
Thickness from top glass surface to wafer	C3	0.445	0.425	0.465
Ball Diameter	D	0.300	0.270	0.330
Total Ball Count	N	35		
Pins Pitch X axis	J1	0.730		
Pins Pitch Y axis	J2	0.600		

Edge to Pin Center Distance along X	S1	0.460	0.430	0.490
Edge to Pin Center Distance along Y	S2	0.420	0.390	0.450

7. Register List

7.1 System Register

Address	Name	Width	Default Value	R/W	Description
0xf0	Chip_ID_high	8	0x20	RO	ChipIDhighbit
0xf1	Chip_ID_low	8	0x35	RO	ChipIDlowbit
0xf2	pad_auto_switch_mode sync_pad_io_dvp pad_vb_hiz_mode sync_pad_io_ebi	8	0x70	RW	[7] pad auto switch mode [6:4] sync pad io dvp [3] pad vb hiz mode [2:0] sync pad io ebi
0xf3	data_pad_io_dvp[7:0]	8	0xff	RW	[7:0] data pad io dvp
0xf4	data_pad_io_ebi[7:0]	8	0x00	RW	[7:0] data pad io ebi
0xf5	data_pad_io_dvp[9:8] data_pad_io_ebi[9:8]	6	0x30	RW	[5:4] data pad io dvp[9:8] [1:0] data pad io ebi[9:8]
0xf6	Up_down Pwd_dn	8	0x00	RW	[5:4] updn 00 not pull 01 pull down 10 pull up 11 illegal [0] PWD dn 0 pull down 1 not pull
0xf7	PLL_mode1	6	0x07	RW	[5:4] serial clk double [3] clk double [2] Mode 24MHz [1] div2en 1: divider MCLK 1/2 0: not divider [0] pll enable 1: enable

					0: disable
0xf8	PLL_mode2	8	0x00	RW	[7] pll dg div enable [6] NA [5:0] divx4
0xf9	Cm_mode	8	0xfe	RW	[7] super clk enable [6] 2pclk enable [5] pclk enable [4] hpclk enable [3] ISP all clock enable [2] serial clock enable [1] re-lock pll [0] not use pll
0xfa	clk_div_mode	8	0x00	RW	[7:4] +1 represent the frequency division number [3:0] represent the high level in one pulse after frequency division Mclk by Div duty 0x11 2 1:1 0x21 3 1:2 0x22 3 2:1 0x31 4 1:3 0x32 4 2:2 0x33 4 3:1 ...
0xfb	i2c_device_id	7	0x78	RW	[7:1] I2C device ID, can write once [0] NA
0xfc	analog_pwc	3	0x06	RW	[2] vpix enable [1] NA [0] analog pwn
0xfe	Reset related	8	0x00	RW	[7] soft reset [6] SPI receiver reset [5] NA [4] restart CISCTL, effective low [3:2] NA [1:0] page select 00: registers in REGF0 01: registers in REGF1 10: registers in REGF2 11: registers in REGF3

7.2 Analog & CISCTL

Address	Name	Width	Default Value	R/W	Description
P0:0x03	Exposure[12:8]	4	0x00	RO	[7:5] NA [4:0] exposure[12:8], use line processing time as the unit.
P0:0x04	Exposure[7:0]	8	0x10	RO	Exposure[7:0], controlled by AEC if AEC is in function
P0:0x05	HB[11:8]	4	0x00	RW	H Blanking
P0:0x06	HB[7:0]	8	0x94	RW	
P0:0x07	VB[12:8]	5	0x00	RW	Vertical blanking, if current exposure < (Vb + window Height) , frame rate will be (Vb + window Height); otherwise frame rate will be determined by exposure
P0:0x08	VB[7:0]	8	0x10	RW	
P0:0x09	Row_start[10:8]	3	0x00	RW	Row Start
P0:0x0a	Row_start[7:0]	8	0x00	RW	
P0:0x0b	Col_start[10:8]	3	0x00	RW	Col start
P0:0x0c	Col_start[7:1]	8	0x08		
P0:0x0d	win_height[10:8]	3	0x04	RW	[7:2] NA [2:0] Window height high bit
P0:0x0e	win_height[7:0]	8	0xd0	RW	Window height low 8 Bit
P0:0x0f	win_width[10:8]	3	0x06	RW	[7:2] NA [2:0] Window width high bit
P0:0x10	win_width[7:1]	8	0x50	RW	window width low bit
P0:0x11	sh_delay[9:8]	2	0x00	RW	[7:3] NA [2:0] sh_delay[9:8]
P0:0x12	sh_delay[7:0]	8	0x28	RW	[7:0] sh_delay[7:0]
P0:0x13	Vs_st	8	0x02	RW	Vs_st
P0:0x14	Vs_et	8	0x02	RW	for dark row time
P0:0x15	Reserved	8	0x00	RW	Reserved
P0:0x16	Reserved	8	0xc1	RW	Reserved
P0:0x17	Mirror_updn	8	0X00	RW	[7:3] Reserved [1] Flip [0] mirror
P0:0x18	Reserved	8	0x0a	RW	Reserved
P0:0x19	Reserved	8	0x05	RW	Reserved
P0:0x1a	Reserved	8	0x00	RW	Reserved
P0:0x1b	Reserved	8	0x44	RW	Reserved
P0:0x1c	Reserved	8	0x11	RW	Reserved

P0:0x1d	Reserved	8	0x00	RW	Reserved
P0:0x1e	Reserved	8	0x13	RW	Reserved
P0:0x1f	Reserved	8	0x00	RW	Reserved
P0:0x20	Reserved	8	0x00	RW	Reserved
P0:0x21	Reserved	8	0x40	RW	Reserved
P0:0x22	Reserved	8	0xb2	RW	Reserved
P0:0x23	Reserved	8	0x05	RW	Reserved
P0:0x24	PAD_drv	8	0x15	RW	[7:6] NA, [5:4] sync drv 0 0:4mA 0 1:8mA 1 0:12mA 1 1:16mA [3:2] data drv 0 0:2mA 0 1:4mA 1 0:8mA 1 1:10mA [1:0] pclk drv 0 0:2mA 0 1:4mA 1 0:8mA 1 1:10mA
P0:0x25	dbrow	8	0x00	RW	[7:1] NA [0] db row
P0:0x3f	RC_P PRC_mode_enable	6	0x11	RW	[7:5] RCP[5:0] float 3.3 [1:0] PRC mode enable [1] postgain RC enable [0] pregain RC enable

CSI/PHY1.0

Address	Name	Width	Default Value	R/W	Description
P3:0x01	DPHY_analog_model	8	0x00	RW	[6] CTD lane1 [5] CTD lane0 [4] CTD clock [2] phy lane1 enable [1] phy lane0 enable [0] phy clock enable
P3:0x02	DPHY_analog_mo	8	0x00	RW	[6:4] lane0 driver

	de2				[2:0] clock lane driver
P3:0x03	DPHY_analog_mode3	8	0x00	RW	[6] lane1 delay [5] lane0 delay [4] clock delay [2:0] lane1 driver
P3:0x04	fifo_prog_full_level[7:0]	8	0xa0	RW	[7:0] fifo full level[7:0]
P3:0x05	fifo_prog_full_level[11:8]	4	0x00	RW	[3:0] fifo full level[11:8]
P3:0x06	fifo_mode	8	0x08	RW	[7] MIPI_CLK_MODULE [6] manual CSI2_up mode [4] FIFO reset mode [3] USE_SRAM1_mode [2] NA [1] switch read [0] switch write
P3:0x10	CSI2_mode	8	0x00	RW	[7] lane enable [6] NA [5] ULP mode [4] MIPI enable [3] bit10switch [2] RAW8 [1] line sync mode [0] double lane enable
P3:0x11	LDI_set	8	0x2b	RW	RAW10
P3:0x12	LWC_set[7:0]	8	0x20	RW	[7:0] LWC set[7:0]
P3:0x13	LWC_set[15:8]	8	0x03	RW	[7:0] LWC set[15:8]
P3:0x14	SYNC_set	8	0xb8	RW	[7:0] SYNC set
P3:0x15	DPHY_mode	8	0x00	RW	[7:4] trigger mode [7] read ready [6] half [5] full [4] programmed [3] PP mode XOL mode [2:1] NA [0] clock lane mode
P3:0x16	LP_set	8	0x09	RW	[7:6] hi-z [3:2] 1 [1:0] 0
P3:0x17	MIPI_wdiv_set	4	0x01	RW	default 1/2
P3:0x20	T_init_set	8	0x80	RW	more than 100 us

P3:0x21	T_LPX_set	8	0x10	RW	more than 50ns
P3:0x22	T_CLK_HS_PRE PARE_set	8	0x05	RW	38ns ~95ns LP00
P3:0x23	T_CLK_zero_set	8	0x30	RW	[7:0] T_CLK_PRE_set ,more than 300ns
P3:0x24	T_CLK_PRE_set	8	0x02	RW	[7:0] T_CLK_PRE_set ,more than 8UI
P3:0x25	T_CLK_POST_set	8	0x10	RW	[7:0] T_CLK_POST_set, 60ns +52UI
P3:0x26	T_CLK_TRAIL_s et	8	0x08	RW	[7:0] T_CLK_TRAIL_set ,60ns
P3:0x27	T_HS_exit_set	8	0x10	RW	[7:0] T_HS_exit_set ,more than 100ns
P3:0x28	T_wakeup_set	8	0xa0	RW	[7:0] T_wakeup_set ,1ms
P3:0x29	T_HS_PREPARE _set	8	0x06	RW	[7:0] T_HS_PREPARE_set,45+4UI ~85+5UI
P3:0x2a	T_HS_Zero_set	8	0x0a	RW	[7:0] T_HS_Zero_se,140ns
P3:0x2b	T_HS_TRAIL_set	8	0x08	RW	[7:0] T_HS_TRAIL_set ,60ns
P3:0x30	external_global_m ode	8	0x03	RW	[4] rec dbrow enable flush [3] EBI dbrow enable [2] raw data [1] reg mode [0] use which edge sample
P3:0x31	external_dvp_mod e	8	0x00	RW	[7] dvp receive enable [2] dvp decode [1] dvp10bit [0] dvp8bit
P3:0x32	external_spi_mode 1	8	0x00	RW	[7] spi receive enable [6] spi1lane2 [5] spi 10 bit [4] spi 10 bit HL [3] don't care reset [2] no sync [1:0] bandwidth
P3:0x33	external_spi_mode 2	8	0x01	RW	[0] spi msb first
P3:0x34	external_spi_reset _width	8	0x80	RW	External spi reset width
P3:0x35	external_row_start [15:8]	8	0x00	RW	External row start[15:0]
P3:0x36	external_row_start [7:0]	8	0x00	RW	
P3:0x37	external_col_start[15:8]	8	0x00	RW	External col start[15:0]
P3:0x38	external_col_start[8	0x00	RW	

	7:0]				
P3:0x39	external_win_height[15:8]	8	0x01	RW	External window height[15:0]
P3:0x3a	external_win_height[7:0]	8	0xe8	RW	
P3:0x3b	external_win_width[15:8]	8	0x02	RW	External window width[15:0]
P3:0x3c	external_win_width[7:0]	8	0x88	RW	
P3:0x3d	pad_delay_cnt	8	0x20	RW	interval of switch pad
P3:0x3e	external_interval	8	0x3f	RW	External interval
P3:0x3f	fifo_error_log	8	0x00	RO	Fifo error log
P3:0x40	output_buf_mode1	8	0x00	RW	[7:4]start mode [3]NA [2:1]delay half clk [0] NA
P3:0x41	output_buf_mode2	8	0x00	RW	2 clk gating 1 pclk polarity 0 hsync polarity
P3:0x42	buf_win_width[7:0]	8	0x40	RW	Buffer window width
P3:0x43	buf_win_width[11:8]	4	0x06	RW	
P3:0x44	buf_win_height[7:0]	8	0x00	RW	Buffer window height
P3:0x45	buf_win_height[10:8]	3	0x00	RW	

7.3 ISP Related

Address	Name	Width	Default Value	R/W	Description
P0:0x80	Block_enable1	8	0x08	RW	[7] BKS enable [6] gamma enable [5] CC enable [4] Edge enhancement enable [3] Interpolation enable [2] second DN enable [1] second DD enable [0] Lens-shading correction enable

P0:0x81	Block_enable2	8	0x00	RW	[7] NA [6] low light Y stretch enable [5] skin detection enable [4] skin Y enable [3] new skin mode [2] autogray enable [1] Y gamma enable [0] NA
P0:0x82	AAAA_enable	8	0x00	RW	[7] Auto SA enable [6] auto EE enable [5] auto DN enable [4] auto DD enable [3] auto LSC enable [2] ABS enable [1] AWB enable [0] auto YEE
P0:0x83	Buf_special_effect	8	0x00	RW	[7:4] effect select [3] edge map2 [2] edge map1 [1] fixed CbCr enable [0] inverse color
P0:0x84	Output_format	8	0x02	RW	[7] YUV420rowswitch [6] YUV420colswitch [5] shake mode [4:0] output data mode 5'h00 Cb Y Cr Y 5'h01 Cr Y Cb Y 5'h02 Y Cb Y Cr 5'h03 Y Cr Y Cb 5'h04 LSC bypass, C/Y 5'h05 LSC bypass, Y/C 5'h06 RGB 565 5'h0f bypass 10bits 5'h11 only Y 5'h12 only Cb 5'h13 only Cr 5'h14 only R 5'h15 only G 5'h16 only B 5'h17 switch odd/even column /row to controls output bayer pattern 00 RGBG

					0 1 RGGB 10 BGGR 11 GBRG 5'h18 DNDD out mode, 5'h19 LSC out mode, 5'h1a pregain out mode 5'h1b EEINTP out mode
P0:0x86	sync_mode	8	0x3f	RW	Synchronize signal output mode [7] data delay half [6] hsync delay half [5] allow pclk around hsync [4] allow pclk around vsync [3] opclk gated in HB 0: not gated 1: gated [2] opclk polarity 0: invert of isp_2pclk(isp_pclk) 1: same as isp_2pclk(isp_pclk) [1] hsync polarity 0: low valid 1: high valid [0] vsync polarity 0: low valid 1: high valid
P0:0x87	block_enable3	5	0x00	RW	[7] middle gamma [5] second DN enable [4] second DD enable [0] auto edge effect
P0:0x89	bypass_mode	8	0x83	RW	[7] allow hsync in row tail [6] single2doublemode [5] first second switch [4] YUV420mode [3] is 8 bit bypass [2] is 10 bit bypass for 8 bit data line FPGA [1:0] bypass which 8bits from 11bit, in is 8 bit bypass mode 11: [10:3]----default 10: [9:2] 01: [8:1] 00: [7:0]
P0:0x8a	Clock gating	8	0x81	RW	Reserved
P0:0x8b	debug_mode1	8	0xac	RW	[7:6] BFF gate mode

					[5:4] YUV BFF gate mode [3:2] pipe gate mode [1] AWB gain mode [0] hide_2_clk_mode	
P0:0x8c	debug_mode2	8	0x00	RW	[7] low light Y ratio [6] skin Y Map [5] skin show halo mode [4] skin map [3] test image mode 1: UXGA 0: VGA [2] input test image [1] LSC test image [0] test image after EEINP	
P0:0x8d	Debug_mode3	8	0x01	RW	[7:4] test image fix value [3] test image fix value mode [2] close INBF clock [1] NA [0] update gain mode	
P0:0x8e	Bayer_mode	8	0x18	RW	[7] YUV420_legacy_mode [6] odd even row switch [5] odd even column switch [4:0] out count limit	
P0:0x90	win_mode_buf	1	0x00	RW	[7:1] NA [0] Crop out Window mode	
P0:0x91	Crop_win	High	4	0x00	RW	Crop_win_y1
P0:0x92	_y1[11:0]	Low	8	0x00	RW	
P0:0x93	Crop_win	High	4	0x00	RW	Crop_win_x1
P0:0x94	_x1[11:0]	Low	8	0x00	RW	
P0:0x95	out_win_h	High	3	0x04	RW	Out window height[10:8]
P0:0x96	eight[10:0]	Low	8	0xb0	RW	Out window height[7:0]
P0:0x97	out_win_	High	3	0x06	RW	Out window width[10:8]
P0:0x98	width[10:0]	Low	8	0x40	RW	Out window width[7:0]
P0:0x99	subsample	8	0x11	RW	[7:4]subsample row ratio [3:0]subsample col ratio	
P0:0x9a	Sub_mode	6	0x06	RW	[5] use or cut row [4] use or cut col [3] smooth Y [2] smooth Chroma [1] neighbor average mode [0] subsample extend opclk	

P0:0x9b	Sub_row_N1	8	0x02	RW	[7:4] subrownum1 [3:0] subrownum2
P0:0x9c	Sub_row_N2	8	0x04	RW	[7:4] subrownum3 [3:0] subrownum4
P0:0x9d	Sub_row_N3	8	0x00	RW	[7:4] subrownum5 [3:0] subrownum6
P0:0x9e	Sub_row_N4	8	0x00	RW	[7:4] subrownum7 [3:0] subrownum8
P0:0x9f	Sub_col_N1	8	0x02	RW	[7:4] subcolnum1 [3:0] subcolnum2
P0:0xa0	Sub_col_N2	8	0x04	RW	[7:4] subcolnum3 [3:0] subcolnum4
P0:0xa1	Sub_col_N3	8	0x00	RW	[7:4] subcolnum5 [3:0] subcolnum6
P0:0xa2	Sub_col_N4	8	0x00	RW	[7:4] subcolnum7 [3:0] subcolnum8
P0:0xc8	output_buf_enable Y_scaler_binning_enable Y_scaler_enable Y_scaler_base	7	0x05	RW	[6] output buffer enable [5] Y scalar binning enable [4] Y scalar enable [3:0] Y scalar base 4/5/6/7/8, scalar ratio = 2/scalar base Ratio=0.4,out=640x480

BLK

Address	Name	Width	Default Value	R/W	Description
P0:0x40	Blk_mode1	8	0x23	RW	[7] not smooth [6:4] BLK smooth speed [3] piece wise sdark [2] dark current mode [1] dark current enable [0] offset enable
P0:0x41	BLK_mode2	8	0x09	RW	Reserved
P0:0x42	BLK limit value	7	0x7f	RW	[7] NA [6:0] When Dark data big than it, while get this to replace it for protect dark data. low align 11bits
P0:0x43	Black compress enable Global offset	7	0x00	RW	[7] Black compress enable [6:0] global offset
P0:0x44	current_G1_offset	7	0x74	RO	[7] NA

	_odd_offset1				[6:0] current G1 offset odd offset1
P0:0x45	current_G1_offset _even_offset1	7	0x7c	RO	[7] NA [6:0] current G1 offset even offset1
P0:0x46	current_R1_offset _odd_offset1	7	0x7c	RO	[7] NA [6:0] current R offset odd offset1
P0:0x47	current_R1_offset _even_offset1	7	0x7c	RO	[7] NA [6:0] current R offset even offset1
P0:0x48	current_B2_offset _odd_offset1	7	0x7c	RO	[7] NA [6:0] current B offset odd offset1
P0:0x49	current_B2_offset _even_offset1	7	0x7c	RO	[7] NA [6:0] current B offset even offset1
P0:0x4A	current_G2_offset _odd_offset1	7	0x7c	RO	[7] NA [6:0] current G2 offset odd offset1
P0:0x4B	current_G2_offset _even_offset1	7	0x7c	RO	[7] NA [6:0] current G2 offset even offset1
P0:0x54	current_G1_offset _odd_dark_current	7	0x3f	RO	[7] NA [6:0] current G1 offset odd dark current
P0:0x55	current_G1_offset _even_dark_curre nt	7	0x3b	RO	[7] NA [6:0] current G1 offset even dark current
P0:0x56	current_R1_offset _odd_dark_current	7	0x44	RO	[7] NA [6:0] current R1 offset odd dark current
P0:0x57	current_R1_offset _even__dark_curr ent	7	0x40	RO	[7] NA [6:0] current R1 offset even dark current
P0:0x58	current_B2_offset _odd_dark_current	7	0x45	RO	[7] NA [6:0] current B1 offset odd offset2
P0:0x59	current_B2_offset _even_dark_curre nt	7	0x41	RO	[7] NA [6:0] current B1 offset even dark current
P0:0x5a	current_G2_offset _odd_dark_current	7	0x3f	RO	[7] NA [6:0] current G2 offset odd dark current
P0:0x5b	current_G2_offset _even_dark_curre nt	7	0x3c	RO	[7] NA [6:0] current G2 offset even dark current
P0:0x5c	Exp_rate_darkc	8	0x04	RW	Exp rate darkc
P0:0x5d	Offset_sub_ mode Darkc_submode	8	0x00	RW	[7:4] Offset sub mode [3:0] Darkc sub mode
P0:0x5e	offset_ratio_G1_o dd_temp	6	0x16	RW	[7:6] NA [5:0] 1.5bits offset_ratio_G1_odd

P0:0x5f	offset_ratio_G1_even_temp	6	0x16	RW	[7:6]NA [5:0] 1.5bits offset_ratio_G1_even
P0:0x60	offset_ratio_R1_odd_temp	6	0x16	RW	[7:6]NA [5:0] 1.5bits offset ratio R odd
P0:0x61	offset_ratio_R1_even_temp	6	0x16	RW	[7:6]NA [5:0] 1.5bits offset ratio R even
P0:0x62	offset_ratio_B2_odd_temp	6	0x16	RW	[7:6]NA [5:0] 1.5bits offset ratio B odd
P0:0x63	offset_ratio_B2_even_temp	6	0x16	RW	[7:6]NA [5:0] 1.5bits offset ratio B even
P0:0x64	offset_ratio_G2_odd_temp	6	0x16	RW	[7:6]NA [5:0] 1.5bits offset ratioG2odd
P0:0x65	offset_ratio_G2_even_temp	6	0x16	RW	[7:6]NA [5:0] 1.5bits offset ratioG2even
P0:0x66	Dark_current_G1_ratio	6	0x18	RW	[7:6]NA [5:0] 1.5bits dark current ratioG1
P0:0x67	Dark_current_R1_ratio	6	0x18	RW	[7:6]NA [5:0] 1.5bits dark current ratio R
P0:0x68	Dark_current_B2_ratio	6	0x18	RW	[7:6]NA [5:0] 1.5bits dark current ratio B
P0:0x69	Dark_current_G2_ratio	6	0x18	RW	[7:6]NA [5:0] 1.5bits dark current ratio G2
P0:0x6A	manual_G1_odd_offset	6	0x00	RW	[7:6] NA [5:0] S5, aligned to lower 8 of 11 bits data
P0:0x6B	manual_G1_even_offset	6	0x00	RW	[7:6] NA [5:0] S5, aligned to lower 8 of 11 bits data
P0:0x6C	manual_R1_odd_offset	6	0x00	RW	[7:6] NA [5:0] S5, aligned to lower 8 of 11 bits data
P0:0x6D	manual_R1_even_offset	6	0x00	RW	[7:6] NA [5:0] S5, aligned to lower 8 of 11 bits data
P0:0x6E	manual_B2_odd_offset	6	0x00	RW	[7:6] NA [5:0] S5, aligned to lower 8 of 11 bits data
P0:0x6F	manual_B2_even_offset	6	0x00	RW	[7:6] NA [5:0] S5, aligned to lower 8 of 11 bits data
P0:0x70	manual_G2_odd_offset	6	0x00	RW	[7:6] NA [5:0] S5, aligned to lower 8 of 11 bits data
P0:0x71	manual_G2_even_offset	6	0x00	RW	[7:6] NA [5:0]S5, aligned to lower 8 of 11 bits data
P0:0x77	black_compress	8	0xf6	RW	[7:4] blackcompress2 [3:0] blackcompress1
P0:0x78	Close frame mode	8	0x44	RW	[7]NA

	Close frame num				[6:4] close frame mode [3:0] close frame number
P0:0x79	Close frame num1	8	0x12	RW	[7:0] close frame num1
P0:0x7a	Close frame num2	8	0x00	RW	[7:0] close frame num2

GLOBAL/PRE/POSTGAIN

Address	Name	Width	Default Value	R/W	Description
P0:0xa3	channel_gain_G1_odd	8	0x80	RW	[7:0] G1 odd Channel gain, float 1.7
P0:0xa4	channel_gain_G1_even	8	0x80	RW	[7:0] G1 even Channel gain, float 1.7
P0:0xa5	channel_gain_R1_odd	8	0x80	RW	[7:0] R1 odd Channel gain, float 1.7
P0:0xa6	channel_gain_R1_even	8	0x80	RW	[7:0] R1 even Channel gain, float 1.7
P0:0xa7	channel_gain_B2_odd	8	0x80	RW	[7:0] B2 odd channel gain, float 1.7
P0:0xa8	channel_gain_B2_even	8	0x80	RW	[7:0] B2 even channel gain, float 1.7
P0:0xa9	channel_gain_G2_odd	8	0x80	RW	[7:0] G2 odd channel gain, float 1.7
P0:0xaa	channel_gain_G2_even	8	0x80	RW	[7:0] G2 even channel gain, float 1.7
P0:0xad	R_ratio	8	0x80	RW	[7:0] R ratio 1.7bits, float 1.7
P0:0xae	G_ratio	8	0x80	RW	[7:0] G ratio 1.7bits, float 1.7
P0:0xaf	B_ratio	8	0x80	RW	[7:0] B ratio 1.7bits, float 1.7
P0:0xb0	Global_gain	8	0x40	RW	Global gain, float 4.4
P0:0xb1	Auto_pregain	8	0x40	RO	[7:0] Controlled by AEC , can be manually controlled when disable AEC
P0:0xb2	Auto_postgain	8	0x40	RO	[7:0] Controlled by AEC , can be manually controlled when disable AEC
P0:0xb3	AWB_R_gain	8	0x40	RO	[7:0] AWB R gain float 4.4
P0:0xb4	AWB_G_gain	8	0x40	RO	[7:0] AWB G gain float 4.4
P0:0xb5	AWB_B_gain	8	0x40	RO	[7:0] AWB B gain float 4.4. controlled by AWB

DNDD/DITHER

Address	Name	Width	Default Value	R/W	Description
---------	------	-------	---------------	-----	-------------

P2:0x86	DN mode	8	0x87	RW	[7:5] Auto DD mode [4] zero weight mode [3] share mode [2] Reserved [1] dn lsc mode [0] Reserved
P2:0x87	DD mode	8	0x22	RW	[7:6] bad ratio [5:4] C weight adaptive ratio [3:2] dn lsc ratio [1:0] dn b mode ratio
P2:0x88	DN_auto_disable DN_bilat_b_base	8	0x15	RW	[7] DN auto disable [6] NA [5:0] Fixed bilateral b value
P2:0x89	DN_bilat_n_base DN_C_weight	8	0x05	RW	[7:4] DN bilat_n base [3:0] base center pixel weight
P2:0x8a	DD_dark_bright_ TH	8	0x05	RW	[7:4] DD dark THD [3:0] DD bright THD
P2:0x8b	DD_flat_TH	8	0x86	RW	[7:4] dd th subtract one [3:0] dd th subtract two
P2:0x8c	DD_limit DN_b_in_dark_in c_or_dec DD_ratio	8	0xf2	RW	[7:4] DD limit, threshold of a defect pixel [3] NA [2] DN datk mode [1:0] DD ratio
P2:0x8d	DN_b_in_dark_ enable DD_mm_TH	8	0x8a	RW	[7] DN bin dark enable [6] DD select weight [3:0] DD mm TH
P2:0x8e	DN_b_in_dark_ th DN_b_in_dark_ slope	8	0xff	RW	[7:4] DN bin dark THD [3:0] DN bin dark slope
P2:0x8f	DN skin mode	5	0x00	RW	Reserved
P2:0x9d	Reserved	3	0x03	RW	Reserved
P2:0x9e	Reserved	8	0x00	RW	Reserved

INTPEE (Interpolation and Edge Enhancement)

Address	Name	Width	Default Value	R/W	Description
P2:0x90	EEINTP mode 1	8	0x6c	RW	[7] edge1 mode [6] new edge mode [5] edge2 mode [4] interpolation select mode

					[3] LP interpolation enable [2] LP edge enable [1:0] LP edge mode
P2:0x91	EEINTP mode 2	8	0x00	RW	Reserved
P2:0x92	Direction TH1	6	0x08	RW	[7:6] NA [5:0] Lower Criteria for direction detection
P2:0x93	Direction TH2	6	0x03	RW	[7:6] NA [5:0] Upper Criteria for direction detection
P2:0x94	Edge THD	8	0x00	RW	Reserved
P2:0x95	direction_diff_TH	8	0x83	RW	[3:0] Direction diff TH1 [3:0] Direction diff TH2
P2:0x96	direction_mode	2	0x00	RW	direction_mode
P2:0x97	Edge1 effect Edge2 effect	8	0x48	RW	[7:4] edge1 effect [3:0] edge2 effect
P2:0x98	Edge_pos_ratio Edge_neg_ratio	8	0x88	RW	[7:4] pos edge ratio [3:0] neg edge ratio
P2:0x99	Edge1_max Edge1_min	8	0x81	RW	[7:4] edge1 max [3:0] edge1 min
P2:0x9a	Edge2_max Edge2_min	8	0x81	RW	[7:4] edge2 max [3:0] edge2 min
P2:0x9b	Edge1_th Edge2_th	8	0x22	RW	[7:4] edge1 threshold [3:0] edge2 threshold
P2:0x9c	Edge_pos_max Edge_neg_max	8	0xf8	RW	[7:4] Positive edge max [3:0] Negative edge max

ASDE

Address	Name	Width	Default Value	R/W	Description
P2:0xa2	ASDE_LSC_gain_dec_slope	8	0x80	RW	[7:0] LSC gain decrease slope
P2:0xa3	ASDE_low_luma_value_th	8	0x20	RW	[7:0] ASDE Offset dark THD
P2:0xa4	ASDE_low_luma_value_offset_slope	4	0x02	RW	[3:0] ASDE low luminance value offset slope
P2:0xa5	ASDE_low_luma_value_LSC_th	8	0x20	RW	[7:0] ASDE LSC dark THD
P2:0xa6	ASDE_low_luma_value_DD_th	8	0x20	RW	[7:0] ASDE DD dark THD
P2:0xa7	ASDE_low_luma_value_OT_th	8	0x20	RW	[7:0] ASDE OT dark THD
P2:0xa9	ASDE DN b	8	0x66	RW	Reserved

P2:0xaa	ASDE DN c	8	0xaa	RW	Reserved
P2:0xab	DN&EEINTP mode	8	0x00	RW	Reserved
P2:0xac	Reserved	6	0x15	RO	Reserved
P2:0xad	Reserved	5	0x10	RO	Reserved
P2:0xae	ASDE_DD_bright_th_slope ASDE_DD_limit_slope	8	0x5f	RW	[7:4] ASDE DD bright Thd slope [3:0] ASDE DD limit slope
P2:0xaf	ASDE_DD_bright_th ASDE_DD_limit	8	0x5f	RO	[7:4] ASDE DD bright THD [3:0] ASDE DD limit
P2:0xb0	ASDE EE low	8	0x12	RW	Reserved
P2:0xb1	ASDE EE1 high	8	0x12	RW	Reserved
P2:0xb2	ASDE edge effect	8	0x48	RO	[7:4] ASDE_edge1_effect [3:0] ASDE_edge2_effect
P2:0xb3	ASDE_auto_saturation_dec_slope	8	0x10	RW	[7:4] Auto saturation decrease slope Float 6.2bit
P2:0xb4	ASDE_auto_saturation_low_limit ASDE_sub_saturation_slope	8	0x31	RW	[7:4] ASDE auto saturation low limit [3:0] ASDE sub saturation slope
P2:0xb5	ASDE_DD_mm_th_slope	4	0xaa	RW	[7:0] ASDE DD mm THD slope
P2:0x48	Reserved	8	0x04	RW	Reserved
P2:0x49	Reserved	8	0x01	RW	Reserved
P2:0x4a	Reserved	8	0x79	RO	Reserved
P2:0x38	auto_gray_dec_slope	4	0x08	RW	[3:0] autogray decrease slope
P2:0x39	auto_gray_dec_th	8	0x40	RW	Autograydecth
P2:0x3a	Reserved	8	0x10	RO	Reserved
P1:0xec	Reserved	8	0x03	RO	Reserved

AUTO_CC

Address	Name	Width	Default Value	R/W	Description
P2:0xc0	CC_mode	8	0x00	RW	[7:6] NA [5:4] CCT mode [3:1] NA [0] CCT enable
P2:0xc1	CC_CT1_11	8	0x40	RW	D-light cc

P2:0xc2	CC_CT1_12	8	0x00	RW	Cwf-light, TL84-light cc
P2:0xc3	CC_CT1_13	8	0x00	RW	
P2:0xc4	CC_CT1_21	8	0x00	RW	
P2:0xc5	CC_CT1_22	8	0x40	RW	
P2:0xc6	CC_CT1_23	8	0x00	RW	
P2:0xc7	CC_CT2_11	8	0x40	RW	
P2:0xc8	CC_CT2_12	8	0x00	RW	
P2:0xc9	CC_CT2_13	8	0x00	RW	
P2:0xca	CC_CT2_21	8	0x00	RW	
P2:0xcb	CC_CT2_22	8	0x40	RW	
P2:0xcc	CC_CT2_23	8	0x00	RW	A-light, U30-light cc
P2:0xcd	CC_CT3_11	8	0x40	RW	
P2:0xce	CC_CT3_12	8	0x00	RW	
P2:0xcf	CC_CT3_13	8	0x00	RW	
P2:0xe3	CC_CT3_21	8	0x00	RW	
P2:0xe4	CC_CT3_22	8	0x40	RW	
P2:0xe5	CC_CT3_23	8	0x00	RW	

RGB GAMMA

Address	Name	Width	Default Value	R/W	Description
P2:0x15	Gamma_out1	8	0x0a	RW	Each out value of knee i. Knee0=2
P2:0x16	Gamma_out2	8	0x12	RW	Knee1=4
P2:0x17	Gamma_out3	8	0x19	RW	Knee2=6
P2:0x18	Gamma_out4	8	0x1f	RW	Knee3=8
P2:0x19	Gamma_out5	8	0x2c	RW	Knee4=12
P2:0x1a	Gamma_out6	8	0x38	RW	Knee5=16
P2:0x1b	Gamma_out7	8	0x42	RW	Knee6=20
P2:0x1c	Gamma_out8	8	0x4e	RW	Knee7=24
P2:0x1d	Gamma_out9	8	0x63	RW	Knee8=32
P2:0x1e	Gamma_out10	8	0x76	RW	Knee9=40
P2:0x1f	Gamma_out11	8	0x87	RW	Knee10=48
P2:0x20	Gamma_out12	8	0x96	RW	Knee11=56
P2:0x21	Gamma_out13	8	0xa2	RW	Knee12=64
P2:0x22	Gamma_out14	8	0xb8	RW	Knee13 =80
P2:0x23	Gamma_out15	8	0xca	RW	Knee14 = 96
P2:0x24	Gamma_out16	8	0xd8	RW	Knee15 = 112
P2:0x25	Gamma_out17	8	0xe3	RW	Knee16 = 128
P2:0x26	Gamma_out18	8	0xf0	RW	Knee17 =160
P2:0x27	Gamma_out19	8	0xf8	RW	Knee18 = 192

P2:0x28	Gamma_out20	8	0xfd	RW	Knee19 = 224
P2:0x29	Gamma_out21	8	0xff	RW	Knee20 = 256

Y GAMMA

Address	Name	Width	Default Value	R/W	Description
P2:0x2b	Y_Gamma_out0	8	0x00	RW	Each out value of knee i. Knee0=0
P2:0x2c	Y_Gamma_out1	8	0x10	RW	Knee1=8
P2:0x2d	Y_Gamma_out2	8	0x1c	RW	Knee2=16
P2:0x2e	Y_Gamma_out3	8	0x30	RW	Knee3=32
P2:0x2f	Y_Gamma_out4	8	0x43	RW	Knee4=48
P2:0x30	Y_Gamma_out5	8	0x54	RW	Knee5=64
P2:0x31	Y_Gamma_out6	8	0x65	RW	Knee6=80
P2:0x32	Y_Gamma_out7	8	0x75	RW	Knee7=96
P2:0x33	Y_Gamma_out8	8	0x93	RW	Knee8=128
P2:0x34	Y_Gamma_out9	8	0xb0	RW	Knee9=160
P2:0x35	Y_Gamma_out10	8	0xcb	RW	Knee10=192
P2:0x36	Y_Gamma_out11	8	0xe6	RW	Knee11=224
P2:0x37	Y_Gamma_out12	8	0xff	RW	Knee12=256

YCP

Address	Name	Width	Default Value	R/W	Description
P2:0xd0	Global saturation	8	0x40	RW	[7:0] Global saturation, controlled by auto saturation
P2:0xd1	saturation_Cb	8	0x30	RW	[7:0] Cb saturation 3.5bits, 0x20=1.0
P2:0xd2	saturation_Cr	8	0x30	RW	[7:0] Cr saturation 3.5bits, 0x20=1.0
P2:0xd3	luma_contrast	8	0x40	RW	[7:0] Luma contrast
P2:0xd4	Contrast center	8	0x80	RW	[7:0] Contrast center value
P2:0xd5	Luma_offset	8	0x00	RW	[7:0] Add offset on luma value. S7.
P2:0xd6	skin_Cb_center	8	0xec	RW	[7:0] Cb criteria for skin detection.
P2:0xd7	skin_Cr_center	4	0x12	RW	[7:0] Cr criteria for skin detection.
P2:0xd8	Skin radius square	6	0x10	RW	[7:0] Defines skin range
P2:0xd9	Skin brightness	8	0xe3	RW	[7:4] skin brightness high threshold

					[3:0] skin brightness low threshold
P2:0xda	Fixed_Cb	8	0x00	RW	S7, if fixed CbCr function is enabled, current image Cb value will be replaced by this value to achieve special effect
P2:0xdb	Fixed_Cr	8	0x00	RW	S7, if fixed CbCr function is enabled, current image Cr value will be replaced by this value to achieve special effect
P2:0xdc	exp_under_sun_th	8	0x32	RW	Exp under sun THD
P2:0xdd	Edge sa-mode	8	0x08	RW	[7] under sun mode [6:4] edge saturation enable [3:0] edge saturation slope
P2:0xde	Asde autogray mode	8	0x38	RW	[7] asde auto gray enable [6] NA [5:4] sa autogray mode [3:0] sa autogray
P2:0xdf	saturation_sub_strength	8	0x00	RO	
P2:0xe0	skin_bright_center	5	0x0f	RW	Skin bright center
P2:0xe1	Y_delta	5	0x18	RW	Gt than 0x18
P2:0xe2	Skin_RR_halo_radius	6	0x20	RO	Chroma offset in low light Gt than 0x10
P2:0xe7	center_U	8	0xe8	RW	Amplitude of skin correction towards Cb
P2:0xe8	center_V	8	0x1f	RW	Amplitude of skin correction towards Cr
P2:0xea	U_bius_div_Radius	8	0x2b	RW	U bius div Radius
P2:0xeb	V_bius_div_Radius	8	0x14	RW	V bius div Radius
P2:0xec	Skin_mode	4	0x03	RW	Reserved

Measure Window

Address	Name	Width	Default Value	R/W	Description
P0:0xec	big_win_x0	8	0x04	RW	Big win use by AEC and AWB
P0:0xed	big_win_y0	8	0x02	RW	
P0:0xee	big_win_x1	8	0x60	RW	
P0:0xef	big_win_y1	8	0x90	RW	

AEC

Address	Name	Width	Default Value	R/W	Description
P0:0xb6	AEC_up_enable AEC_enable	2	0x00	RW	[7:2] NA [1] AEC up enable [0] AEC enable
P1:0x01	aec_x1	8	0x04	RW	[7:0] X16 local measure window
P1:0x02	aec_x2	8	0x60	RW	[7:0] X16 local measure window
P1:0x03	aec_y1	8	0x02	RW	[7:0] aec_y1, X8
P1:0x04	aec_y2	8	0x90	RW	[7:0] aec_y2, X8
P1:0x05	aec_center_x1	8	0x20	RW	[7:0] aec_center_x1, X16
P1:0x06	aec_center_x2	8	0x40	RW	[7:0] aec_center_x2, X16
P1:0x07	aec_center_y1	8	0x40	RW	[7:0] aec_center_y1, X8
P1:0x08	aec_center_y2	8	0x60	RW	[7:0] aec_center_y2, X8
P1:0x09	AEC_mode	8	0x40	RW	[7] Reserved
P1:0x0a	AEC_mode1	8	0x01	RW	[7] low light mode, [6] measure point [5] exposure mode [4] fix frame rate mode [3:2] EC parameters [1:0] skip mode
P1:0x0b	AEC_mode2	8	0x21	RW	[7] fix target [6:4] AEC take action every N frame [3:2] close frame number to eliminate bad frame [1] change exposure gain mode [0] Reserved
P1:0x0c	AEC_mode3	8	0x01	RW	[7] map measure point [6:4] center weight mode [3:2] skin weight mode [1] raw skip mode [0] fix target high
P1:0x0d	AEC_mode4	8	0x00	RW	[7] new exposure mode [6:4] new exposure mode index [3:0] Reserved
P1:0x0e	AEC_thd[7:0]	8	0x40	RW	AEC parameters
P1:0x0f	AEC_thd[15:8]	8	0x60	RW	AEC parameters
P1:0x10	skin_exp_thd	8	0x09	RW	Skin mode exposure thd
P1:0x11	AEC_slope	8	0x40	RW	AEC Y target slope
P1:0x12	AEC_target_skin	8	0x60	RW	AEC target skin
P1:0x13	AEC_target_Y	8	0x50	RW	expected luminance value
P1:0x14	Y_average	8	0x80	RO	Current frame luminance average

P1:0x15	AEC_high_low_range	8	0xf2	RW	[7:4] x16, count limit for high luminance pixels [3:0] x4, count limit for low luminance pixels
P1:0x16	AEC_number_limit_high_range	8	0x35	RW	AEC number limit high range
P1:0x17	AEC_ignore	8	0x18	RW	[7] high luminance limit mode [6] only center limit mode [5:4] aec ignore enable [3:0] ignore same level
P1:0x18	AEC_slow_margin AEC_slow_speed	8	0x9 0x1	RW	[7:4] AEC slow margin, X4 [2:0] AEC slow speed
P1:0x19	AEC_fast_margin AEC_fast_speed	8	0x96	RW	[7:4] AEC fast margin, X4 [3] NA [2:0] AEC fast speed
P1:0x1a	AEC_exp_change_gain_ratio	8	0x96	RW	Gain change criteria, float 1.7, default use 1.2x
P1:0x1b	AEC_step2_sunlight	8	0x01	RW	AEC step2 sunlight
P1:0x1c	AEC_I_frames AEC_D_ratio	6	0x33	RW	[7:6] NA [5:4] mode for Y difference selection [3:0] differential coefficient in AEC control algorithm
P1:0x1d	AEC_I_stop_L_margin	7	0x07	RW	[7] NA [6:0] x2, Will be used as AEC convergence margin when P0:0xd1[0]=0
P1:0x1e	AEC_I_stop_margin AEC_I_ratio	8	0x61	RW	[7:4] AEC adjust stop margin [3:0] integration coefficient
P1:0x1f	AEC_max_postgain	8	0xc0	RW	Max postgain 2.6, 3X
P1:0x20	AEC_max_pregain	8	0x60	RW	Max pregain 2.6, 1.5X
P1:0x21	AEC_ASDE_select_luma_value AEC_low_light_exp_THD_max[12:8]	8	0x8f	RW	[7:5] select div luminance value [4:0]AEC low light exposure THD max
P1:0x22	AEC_low_light_	8	0x00	RW	dbrow enter mode

	exp_THD_max[7:0]				
P1:0x23	AEC_low_light_exp_THD_min[12:8]	5	0x06	RW	aec low light invalid exposure thd dbrow exit mode, exp/2
P1:0x24	AEC_low_light_exp_THD_min[7:0]	8	0x40	RW	
P1:0x25	AEC_low_light_gain_High	8	0x40	RW	3.5bits aec low light valid gain THD
P1:0x26	AEC_low_light_gain_Low	8	0x30	RW	3.5bits aec low light invalid gain THD
P1:0x27	AEC_anti_flicker_step[12:8]	8	0x01	RW	[7:5]NA [4:0] AEC anti flicker step[12:8]
P1:0x28	AEC_anti_flicker_step[7:0]	8	0x68	RW	AEC anti flicker step[7:0]
P1:0x29	AEC_exp_level_1[12:8]	8	0x04	RW	[7:5] NA [4:0] AEC exposure level1[12:8]
P1:0x2a	AEC_exp_level_1[7:0]	8	0x38	RW	AEC exposure level1[7:0]
P1:0x2b	AEC_exp_level_2[12:8]	8	0x05	RW	[7:5] NA [4:0] AEC exposure level2[12:8]
P1:0x2c	AEC_exp_level_2[7:0]	8	0xa0	RW	AEC exposure level2[7:0]
P1:0x2d	AEC_exp_level_3[12:8]	8	0x09	RW	[7:5] NA [4:0] AEC exposure level3[12:8]
P1:0x2e	AEC_exp_level_3[7:0]	8	0xd8	RW	AEC exposure level_3[7:0]
P1:0x2f	AEC_exp_level_4[12:8]	8	0x0e	RW	[7:5] NA [4:0] AEC exposure level 4[12:8]
P1:0x30	AEC_exp_level_4[7:0]	8	0x10	RW	AEC exposure level 4 [7:0]
P1:0x31	AEC_exp_level_5[12:8]	8	0x10	RW	[7:5] NA [4:0] AEC exposure level 5[12:8]
P1:0x32	AEC_exp_level_5[7:0]	8	0xe0	RW	AEC exposure level 5 [7:0]
P1:0x33	AEC_exp_level_6[12:8]	8	0x1c	RW	[7:5] NA [4:0] AEC exposure level 6[12:8]
P1:0x34	AEC_exp_level_6[7:0]	8	0x20	RW	AEC exposure level 6[7:0]
P1:0x35	AEC_exp_level_	8	0x1c	RW	[7:5] NA

	7[12:8]				[4:0] AEC exposure level7[12:8]
P1:0x36	AEC_exp_level_7[7:0]	8	0x20	RW	AEC exposure level 7[7:0]
P1:0x37	AEC_max_dg_gain1	8	0x40	RW	4.4bits, AEC max dg gain1
P1:0x38	AEC_max_dg_gain2	8	0x40	RW	4.4bits, AEC max dg gain2
P1:0x39	AEC_max_dg_gain3	8	0x40	RW	4.4bits, AEC max dg gain3
P1:0x3a	AEC_max_dg_gain4	8	0x40	RW	4.4bits, AEC max dg gain4
P1:0x3b	AEC_max_dg_gain5	8	0x40	RW	4.4bits, AEC max dg gain5
P1:0x3c	AEC_max_dg_gain6	8	0x40	RW	4.4bits, AEC max dg gain6
P1:0x3d	AEC_max_dg_gain7	8	0x40	RW	4.4bits, AEC max dg gain7
P1:0x3e	AEC_max_exp_level AEC_exp_min_1[12:8]	8	0x20	RW	[6:5] Max level setting [4:0] exposure min[12:8]
P1:0x3f	AEC_exp_min_1[7:0]	8	0x04	RW	exposure min[7:0]
P1:0x40	L_AEC_anti_flicker_step[12:8]	8	0x00	RW	[7:5] NA [4:0] Low light AEC anti flicker step[12:8]
P1:0x41	L_AEC_anti_flicker_step[7:0]	8	0xb4	RW	Low light AEC anti flicker step[7:0]
P1:0x42	L_AEC_exp_level_1[12:8]	8	0x02	RW	[7:5] NA [4:0] Low light AEC exposure level1[12:8]
P1:0x43	L_AEC_exp_level_1[7:0]	8	0x1c	RW	In low light exposure level 1
P1:0x44	L_AEC_exp_level_2[12:8]	8	0x02	RW	[7:5] NA [4:0] Low light AEC exposure level 2[12:8]
P1:0x45	L_AEC_exp_level_2[7:0]	8	0xd0	RW	In low light exposure level 2
P1:0x46	L_AEC_max_exp_level	2	0x01	RW	Low light AEC max exposure level
P1:0x47	AEC parameters	8	0x80	RW	AEC parameters

P1:0x48	AEC parameters	8	0x40	RW	AEC parameters
---------	----------------	---	------	----	----------------

AWB

Address	Name	Width	Default Value	R/W	Description
P1:0x50	AWB PRE mode	8	0x00	RW	[7] PRE enable [6:0] Reserved
P1:0x51	AWB parameters	8	0x80	RW	AWB parameters
P1:0x52	AWB parameters	8	0x01	RW	AWB parameters
P1:0x53	AWB parameters	8	0x80	RW	AWB parameters
P1:0x54	AWB parameters	8	0x0f	RW	AWB parameters
P1:0x55	AWB parameters	8	0x00	RW	AWB parameters
P1:0x56	AWB parameters	8	0x00	RW	AWB parameters
P1:0x57	AWB parameters	8	0x20	RW	AWB parameters
P1:0x58	AWB parameters	8	0x00	RW	AWB parameters
P1:0x59	AWB parameters	8	0x01	RW	AWB parameters
P1:0x5a	AWB parameters	8	0xf0	RW	AWB parameters
P1:0x5b	AWB parameters	8	0x0f	RW	AWB parameters
P1:0x5c	AWB parameters	8	0xf0	RW	AWB parameters
P1:0x5d	AWB parameters	8	0x01	RW	AWB parameters
P1:0x5e	AWB parameters	8	0xa4	RW	AWB parameters
P1:0x5f	AWB parameters	8	0x8a	RW	AWB parameters
P1:0x60	AWB parameters	6	0x00	RW	AWB parameters
P1:0x61	AWB parameters	8	0xdc	RW	AWB parameters
P1:0x62	AWB parameters	8	0xca	RW	AWB parameters
P1:0x63	AWB parameters	4	0x00	RW	AWB parameters
P1:0x65	Reserved			RO	Reserved
P1:0x66	Reserved			RO	Reserved
P1:0x67	Reserved			RO	Reserved
P1:0x68	Reserved			RO	Reserved
P1:0x69	Reserved			RO	Reserved
P1:0x6a	Reserved			RO	Reserved
P1:0x6b	Reserved			RO	Reserved
P1:0x6c	Reserved			RO	Reserved
P1:0x6d	Reserved			RO	Reserved
P1:0x6e	Reserved			RO	Reserved
P1:0x6f	Reserved			RO	Reserved
P1:0x70	AWB parameters	8	0xff	RW	AWB parameters
P1:0x71	AWB parameters	8	0x10	RW	AWB parameters
P1:0x72	AWB parameters	8	0x18	RW	AWB parameters

P1:0x73	AWB parameters	8	0x10	RW	AWB parameters
P1:0x74	AWB parameters	8	0x20	RW	AWB parameters
P1:0x75	AWB parameters	8	0xf8	RW	AWB parameters
P1:0x76	AWB parameters	8	0x10	RW	AWB parameters
P1:0x77	AWB parameters	8	0x10	RW	AWB parameters
P1:0x78	AWB parameters	8	0xf8	RW	AWB parameters
P1:0x79	AWB parameters	8	0xff	RW	AWB parameters
P1:0x7a	AWB parameters	8	0xff	RW	AWB parameters
P1:0x7b	AWB parameters	8	0x00	RW	AWB parameters
P1:0x7c	AWB parameters	8	0xfe	RW	AWB parameters
P1:0x7d	AWB parameters	8	0x00	RW	AWB parameters
P1:0x7e	AWB parameters	8	0x00	RW	AWB parameters
P1:0x7f	AWB parameters	8	0x00	RW	AWB parameters
P1:0x80	AWB parameters	8	0x12	RW	AWB parameters
P1:0x81	AWB parameters	8	0xa0	RW	AWB parameters
P1:0x84	AWB_skip_mode	4	0x00	RW	[7:2] Reserved [1:0]AWB skip mode
P1:0x85	AWB parameters	8	0x60	RW	AWB parameters
P1:0x86	AWB parameters	8	0x30	RW	AWB parameters
P1:0x87	AWB parameters	6	0x22	RW	[5:4] adjust every frame [3:0] Reserved
P1:0x88	show_and_mode	8	0x0f	RW	Reserved
P1:0x89	adjust_speed adjust_margin	8	0x42	RW	[7] NA [6:4] AWB gain adjust speed, the bigger the quicker. [3:0] if average of R/G/B's difference is smaller than margin, it means AWB is OK, and AWB will stop.
P1:0x8a	AWB_move_mode	8	0x00	RW	[7] move mode enable [6:0] AWB move THD
P1:0x8b	AWB parameters	8	0x00	RW	AWB parameters
P1:0x8c	AWB parameters	8	0x00	RW	AWB parameters
P1:0x8d	AWB_R_gain_limit	8	0x70	RW	Channel gain limit for R, G, B. Float 2.6
P1:0x8e	AWB_G_gain_limit	8	0x58	RW	
P1:0x8f	AWB_B_gain_limit	8	0x78	RW	
P1:0x90	Reserved	8	0x50	RW	Reserved
P1:0x91	Reserved	8	0x58	RW	AWB parameters
P1:0x92	Reserved	8	0x46	RW	AWB parameters

P1:0x93	Reserved	8	0x40	RW	AWB parameters
P1:0x94	Reserved	8	0x40	RW	AWB parameters
P1:0x95	Reserved	8	0x40	RW	AWB parameters
P1:0x96	Reserved	8	0x40	RW	AWB parameters
P1:0x97	Reserved	8	0x40	RW	AWB parameters
P1:0x98	Reserved	8	0x40	RW	AWB parameters

ABS

Address	Name	Width	Default Value	R/W	Description
P1:0x9a	ABS mode	8	0xf3	RW	Reserved
P1:0x9b	ABS_stop_margin	4	0x02	RW	[7:4] NA [3:0] margin for ABS to stop adjustment
P1:0x9c	ABS_manual_K	8	0x00	RW	[7:4] Reserved [3:0] manual ABS slope adjustment, default 0
P1:0x9d	Y_stretch_limit	8	0x40	RW	[7:0] Y stretch limit
P1:0x9e	Reserved			RO	Reserved
P1:0x9f	Reserved			RO	Reserved

LSC

Address	Name	Width	Default Value	R/W	Description
P1:0xa0	LSC_row_x2 LSC_col_x2 auto_LSC_AWB LSC_ADlight_parameter_select LSC_pixel_array_select	8	0x03	RW	[7:6] NA [5] LSC_row_x2 [4] LSC_col_x2 [3] Reserved [2] LSC AD light parameter select [1:0] LSC pixel array select
P1:0xa1	LSC_row_center	8	0x80	RW	LSC row center
P1:0xa2	LSC_col_center	8	0x80	RW	LSC col center
P1:0xa4	LSC_Sign1	8	0x00	RW	[6] LSC_Q1_red_b1_sign [5] LSC_Q1_green_b1_sign [4] LSC_Q1_blue_b1_sign [2] LSC_Q2_red_b1_sign [1] LSC_Q2_green_b1_sign [0] LSC_Q2_blue_b1_sign
P1:0xa5	LSC_Sign2	8	0x00	RW	[6] LSC_Q3_red_b1_sign

					[5] LSC_Q3_green_b1_sign [4] LSC_Q3_blue_b1_sign [2] LSC_Q4_red_b1_sign [1] LSC_Q4_green_b1_sign [0] LSC_Q4_blue_b1_sign
P1:0xa6	LSC_Sign3	8	0x00	RW	[6] LSC_right_red_b4_sign [5] LSC_right_green_b4_sign [4] LSC_right_blue_b4_sign [2] LSC_left_red_b4_sign [1] LSC_left_green_b4_sign [0] LSC_left_blue_b4_sign
P1:0xa7	LSC_Sign4	8	0x00	RW	[6] LSC_up_red_b4_sign [5] LSC_up_green_b4_sign [4] LSC_up_blue_b4_sign [2] LSC_down_red_b4_sign [1] LSC_down_green_b4_sign [0] LSC_down_blue_b4_sign
P1:0xa8	LSC_Sign5	8	0x00	RW	[6] LSC_right_up_red_b22_sign [5] LSC_right_up_green_b22_sign [4] LSC_right_up_blue_b22_sign [2] LSC_right_down_red_b22_sign [1] LSC_right_down_green_b22_sign [0] LSC_right_down_blue_b22_sign
P1:0xa9	LSC_Sign6	8	0x00	RW	[6] LSC_left_up_red_b22_sign [5] LSC_left_up_green_b22_sign [4] LSC_left_up_blue_b22_sign [2] LSC_left_down_red_b22_sign [1] LSC_left_down_green_b22_sign [0] LSC_left_down_blue_b22_sign
P1:0xaa	LSC_Q1_red_b1_0	8	0x20	RW	LSC Q1 red b10
P1:0xab	LSC_Q1_green_b1	8	0x20	RW	LSCQ1 green b1
P1:0xac	LSC_Q1_blue_b1	8	0x20	RW	LSC Q1 blue b1
P1:0xad	LSC_Q2_red_b1_0	8	0x20	RW	LSC Q2 red b10
P1:0xae	LSC_Q2_green_b1	8	0x20	RW	LSC Q2 green b1
P1:0xaf	LSC_Q2_blue_b1	8	0x20	RW	LSC Q2 blue b1
P1:0xb0	LSC_Q3_red_b1	8	0x20	RW	LSC Q3 red b10

	_0				
P1:0xb1	LSC_Q3_green_b1	8	0x20	RW	LSC Q3 green b1
P1:0xb2	LSC_Q3_blue_b1	8	0x20	RW	LSC Q3 blue b1
P1:0xb3	LSC_Q4_red_b1_0	8	0x20	RW	LSC Q4 red b10
P1:0xb4	LSC_Q4_green_b1	8	0x20	RW	LSC Q4 green b1
P1:0xb5	LSC_Q4_blue_b1	8	0x20	RW	LSC Q4 blue b1
P1:0xb6	LSC_right_red_b2_0	8	0x20	RW	LSC right red b20
P1:0xb7	LSC_right_green_b2	8	0x20	RW	LSC right green b2
P1:0xb8	LSC_right_blue_b2	8	0x20	RW	LSC right blue b2
P1:0xb9	LSC_right_red_b4_0	8	0x20	RW	LSC right red b40
P1:0xba	LSC_right_green_b4	8	0x20	RW	LSC right green b4
P1:0xbb	LSC_right_blue_b4	8	0x20	RW	LSC right blue b4
P1:0xbc	LSC_left_red_b2_0	8	0x20	RW	LSC left red b20
P1:0xbd	LSC_left_green_b2	8	0x20	RW	LSC left green b2
P1:0xbe	LSC_left_blue_b2	8	0x20	RW	LSC left blue b2
P1:0xbf	LSC_left_red_b4_0	8	0x20	RW	LSC left red b40
P1:0xc0	LSC_left_green_b4	8	0x20	RW	LSC left green b4
P1:0xc1	LSC_left_blue_b4	8	0x20	RW	LSC left blue b4
P1:0xc2	LSC_up_red_b2_0	8	0x20	RW	LSC up red b20
P1:0xc3	LSC_up_green_b2	8	0x20	RW	LSC up green b2
P1:0xc4	LSC_up_blue_b2	8	0x20	RW	LSC up blue b2

P1:0xc5	LSC_up_red_b4_0	8	0x20	RW	LSC up red b40
P1:0xc6	LSC_up_green_b4	8	0x20	RW	LSC up green b4
P1:0xc7	LSC_up_blue_b4	8	0x20	RW	LSC up blue b4
P1:0xc8	LSC_down_red_b2_0	8	0x20	RW	LSC down red b20
P1:0xc9	LSC_down_green_b2	8	0x20	RW	LSC down green b2
P1:0xca	LSC_down_blue_b2	8	0x20	RW	LSC down blue b2
P1:0xcb	LSC_down_red_b4_0	8	0x20	RW	LSC down red b40
P1:0xcc	LSC_down_green_b4	8	0x20	RW	LSC down green b4
P1:0xcd	LSC_down_blue_b4	8	0x20	RW	LSC down blue b4
P1:0xd0	LSC_right_up_red_b22_0	8	0x20	RW	LSC right up red b220
P1:0xd1	LSC_right_up_red_b22_1	8	0x20	RW	LSC right up red b221
P1:0xd2	LSC_right_up_green_b22_0	8	0x20	RW	LSC right up green b220
P1:0xd3	LSC_right_up_blue_b22_0	8	0x20	RW	LSC right up blue b220
P1:0xd4	LSC_right_down_red_b22_0	8	0x20	RW	LSC right down red b220
P1:0xd5	LSC_right_down_red_b22_1	8	0x20	RW	LSC right down red b221
P1:0xd6	LSC_right_down_green_b22_0	8	0x20	RW	LSC right down green b220
P1:0xd7	LSC_right_down_blue_b22_0	8	0x20	RW	LSC right down Blue b220
P1:0xd8	LSC_left_up_red_b22_0	8	0x20	RW	LSC left up red b220
P1:0xd9	LSC_left_up_red_b22_1	8	0x20	RW	LSC left up red b221
P1:0xda	LSC_left_up_green_b22_0	8	0x20	RW	LSC left up green b22_0
P1:0xdb	LSC_left_up_blue_b22_0	8	0x20	RW	LSC left up blue b220

	e_b22_0				
P1:0xdc	LSC_left_down_red_b22_0	8	0x20	RW	LSC left down red b220
P1:0xdd	LSC_left_down_red_b22_1	8	0x20	RW	LSC left down red b221
P1:0xde	LSC_left_down_green_b22_0	8	0x20	RW	LSC left down green b220
P1:0xdf	LSC_left_down_blue_b22_0	8	0x20	RW	LSC left down blue b220
P1:0xe0	LSC_Q1_red_b1_1	8	0x20	RW	LSC Q1 red b11
P1:0xe1	LSC_Q2_red_b1_1	8	0x20	RW	LSC Q2 red b11
P1:0xe2	LSC_Q3_red_b1_1	8	0x20	RW	LSC Q3 red b11
P1:0xe3	LSC_Q4_red_b1_1	8	0x20	RW	LSC Q4 red b11
P1:0xe4	LSC_right_red_b2_1	8	0x20	RW	LSC right red b21
P1:0xe5	LSC_right_red_b4_1	8	0x20	RW	LSC right red b41
P1:0xe6	LSC_left_red_b2_1	8	0x20	RW	LSC left red b21
P1:0xe7	LSC_left_red_b4_1	8	0x20	RW	LSC left red b41
P1:0xe8	LSC_up_red_b2_1	8	0x20	RW	LSC up red b21
P1:0xe9	LSC_up_red_b4_1	8	0x20	RW	LSC up red b41
P1:0xea	LSC_down_red_b2_1	8	0x20	RW	LSC down red b21
P1:0xeb	LSC_down_red_b4_1	8	0x20	RW	LSC down red b41
P1:0x4a	LSC_right_green_b4_1	8	0x20	RW	A LSC right green b41
P1:0x4b	LSC_left_green_b4_1	8	0x20	RW	A LSC left green b41
P1:0x4c	LSC_up_green_b4_1	8	0x20	RW	A LSC up green b41
P1:0x4d	LSC_down_green_b4_1	8	0x20	RW	A LSC down green b41

P1:0x4e	LSC_right_up_green_b22_1	8	0x20	RW	A LSC right up green b221
P1:0x4f	LSC_right_down_green_b22_1	8	0x20	RW	A LSC right down green b221
P1:0xce	LSC_left_up_green_b22_1	8	0x20	RW	A LSC left up green b221
P1:0xcf	LSC_left_down_green_b22_1	8	0x20	RW	A LSC left down green b221

Revision History

Version1.0 2012.09.07

- Document Release

Version1.0 2012.09.18

- AVDD28 power voltage range update