

## Description

The GCD4402 is designed to perform the basic signal processing in CCD monochrome camera through a single chip. This bipolar IC is most suitable for compact usage and low power consumption.

## Feature

- Processing from CCD output to 75Ω video output with a single chip
- Wide variable AGC (1 to 32 dB Typ.)
- Built-in operational amplifier for AGC loop
- 75Ω line capacitance minimized using sag compensation function
- Variable white clip level realize wide dynamic range (140 IRE)
- 32pin TQFP

## Application

CCD monochrome camera

## Absolute Maximum Ratings (Ta = 25 °C)

Symbol	Parameter	Rating	Unit
Vcc	Supply Voltage	7	V
TSTG	Storage Temperature	-65 ~ +150	°C
TOPR	Operating Temperature	-20 ~ +75	°C
PD	Allowable Power Dissipation	500	mW

## Operating Conditions

Symbol	Parameter	Rating	Unit
Vcc	Supply Voltage	4.75 ~ 5.25	V

## Block Diagram

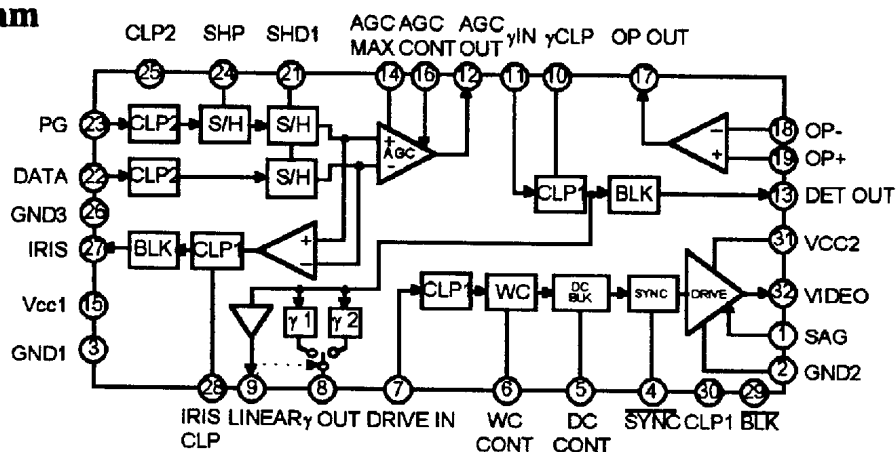

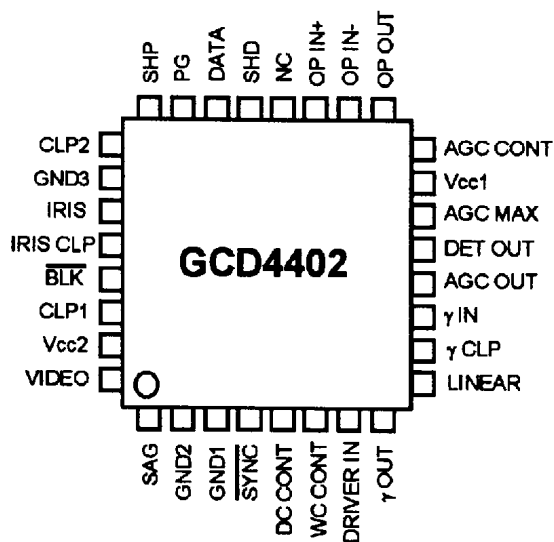

## Pin Configuration





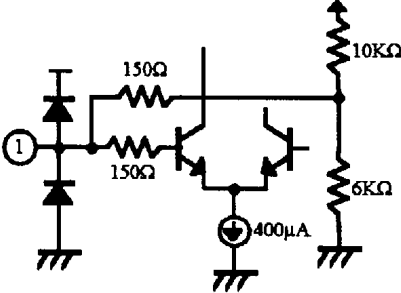

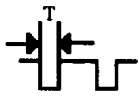
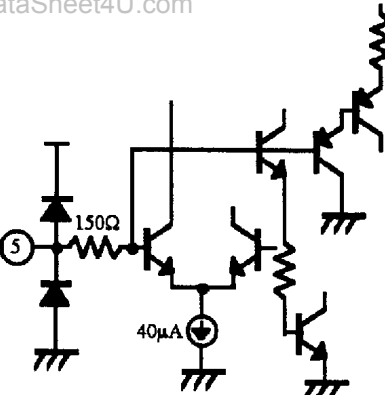
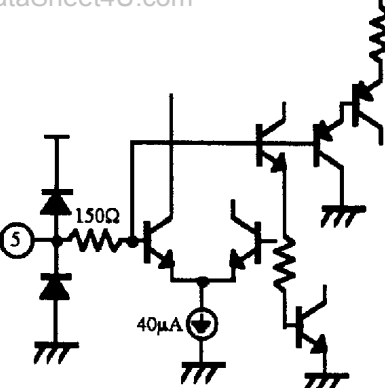
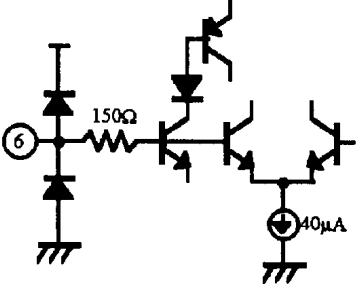
## 32 PIN TQFP



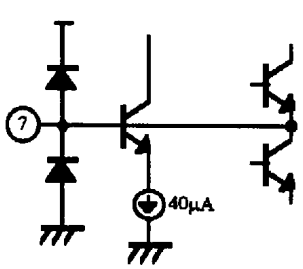

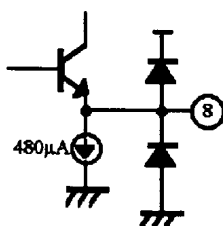
## Pin Description

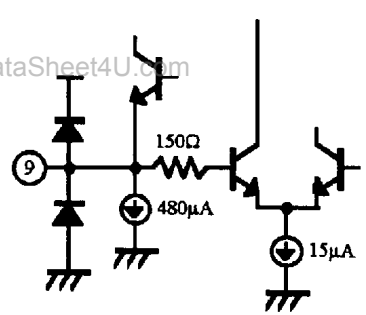
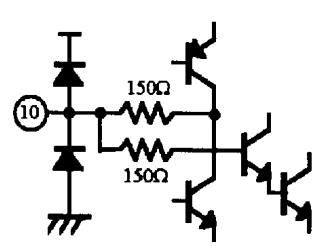
NO.	Symbol	I/O signal	Equivalent circuit	Description
1	SAG	Inputs VIDEO OUT through capacitor		Input pin of sag compensation signal
2	GND2	* GND		GND for driver and IRIS
3	GND1	* GND		GND for other than driver and sample hold and IRIS
4	 SYNC	 HI : 4.5V and above LO : 0.5V and below T : 5 μs		Sync pulse input pin (active at LO)
5	DC CONT	* GND * 2 to 3.5V * Vcc		Dark clip level adjusting pin Turns to preset mode 1 Control mode Turns to preset mode 2
6	WC CONT	* GND * 2 to 3.5V		White clip level adjusting pin Preset mode Control mode

\*External applied voltage

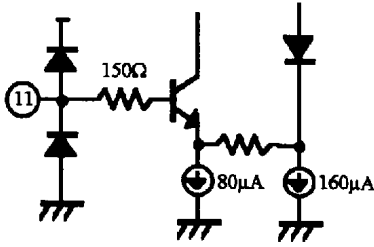
NO.	Symbol	I/O signal	Equivalent circuit	Description
7	DRIVE IN	Inputs $\gamma$ OUT through capacitor or LINEAR		Input pin to driver
8	$\gamma$ OUT	 DC 2V		Gamma compensation signal output pin. Outputs $\gamma_1$ when Pin 9 at OPEN outputs $\gamma_2$ when Pin 9 turned to 5V
9	LINEAR	 DC 1.8V  * Vcc		Linear signal ( $\gamma$ - OFF signal) output pin  Pin 8 output signal turns to $\gamma_2$ output
10	$\gamma$ CLP			Capacitor connecting pin for gamma input clamp

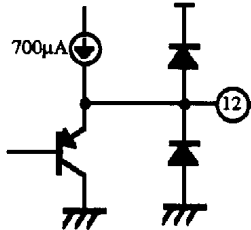

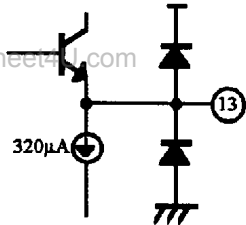
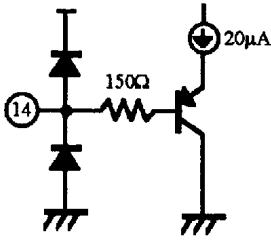
\*External applied voltage

NO.	Symbol	I/O signal	Equivalent circuit	Description
11	$\gamma$ IN	 Input DC permissible range *DC2 to 3V		Input pin of the gamma compensation circuit
12	AGC OUT	 Vpp MAX 1300mV Vpp TYP 500mV DC 2.55V		Output pin of signal passed through AGC
13	DET OUT	 MAX 1500mV TYP 500mV DC 2V		Output pin of AGC detection signal
14	AGC MAX	* DC		Maximum gain setting pin of AGC amplifier
15	Vcc1	*5V		Power supply for other than driver and IRIS

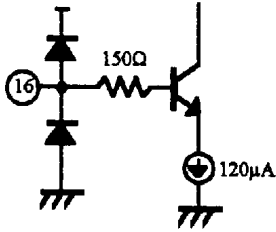
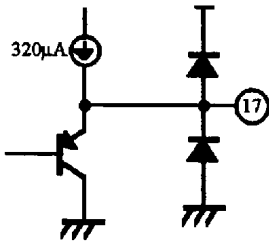
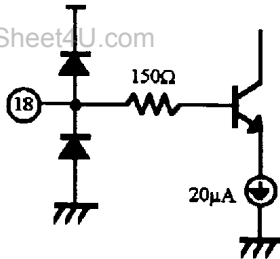
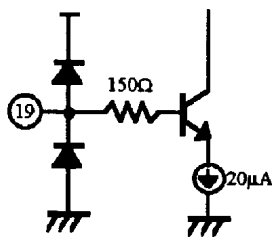

\*External applied voltage

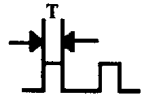
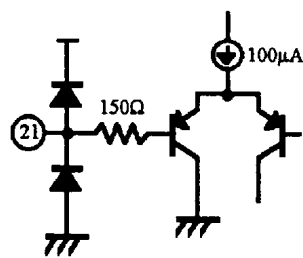
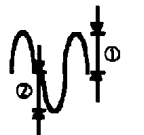
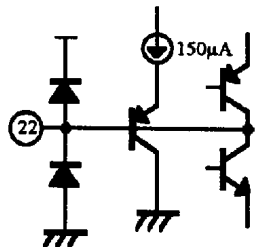
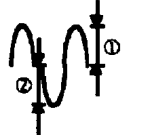
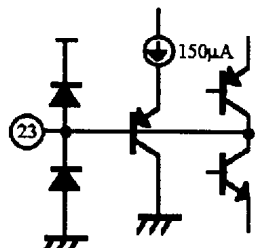
NO.	Symbol	I/O signal	Equivalent circuit	Description
16	AGC CONT	* DC		Gain control pin of AGC amplifier
17	OP OUT			Output pin of the operational amplifier
18	OP IN-			Inverted input pin of the operational amplifier
19	OP IN+			Non inverted input pin of the operational amplifier (AGC detection signal input pin)

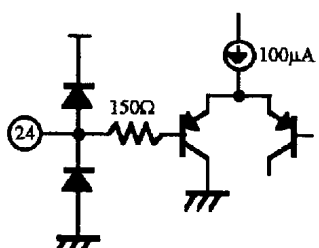

\*External applied voltage

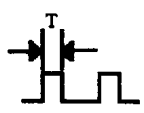
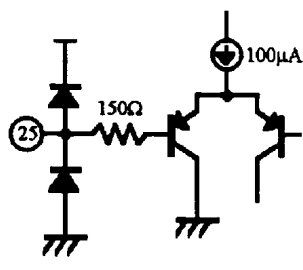
NO.	Symbol	I/O signal	Equivalent circuit	Description
20	NC			
21	SHD	 <p>* HI : 4.5V and above LO : 0.5V and below T : 15ns and above</p>		Input pin of the sample hold pulse (active at HI)
22	DATA	 <p>① MAX 800mV ② MAX 800mV</p>		CCD signal input pin
23	PG	 <p>① MAX 800mV ② MAX 800mV</p>		CCD signal input pin
24	SHP	 <p>* HI : 4.5V and above LO : 0.5V and below T : 15ns</p>		Input pin of the sample hold pulse (active at HI)

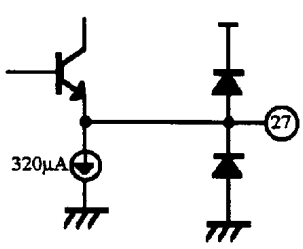
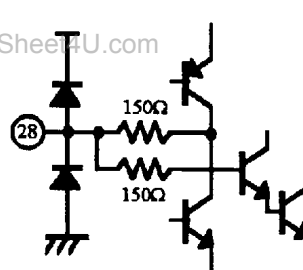
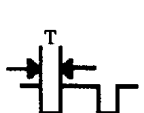
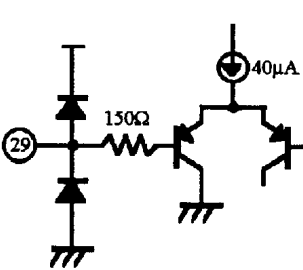
\*External applied voltage

NO.	Symbol	I/O signal	Equivalent circuit	Description
25	CLP2	 * HI : 4.5V and above LO : 0.5V and below T : 2 $\mu$ s		CLP2 pulse input pin (active at HI)
26	GND3	*GND		Sample hold GND
27	IRIS	 DC 1.3V		Output pin of the IRIS control signal
28	IRIS CLP			Capacitor connecting pin for IRIS output clamp
29	$\overline{\text{BLK}}$	 * HI : 4.5V and above LO : 0.5V and below T : 11 $\mu$ s		BLK pulse input pin (active at LO)

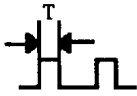
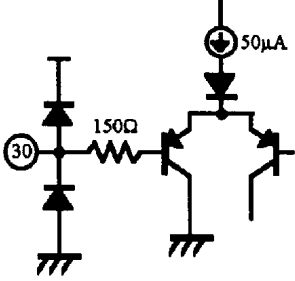
\*External applied voltage

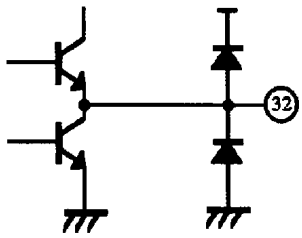
NO.	Symbol	I/O signal	Equivalent circuit	Description
30	CLP1	 <p>* HI : 4.5V and above LO : 0.5V and below T : 2 <math>\mu</math>s</p>		CLP1 pulse input pin (active at HI)
31	Vcc2	* 5V		Driver and IRIS power supply
32	VIDEO	 <p>BLK level 1.5V</p>		VIDEO signal output pin



**Electrical Characteristics** ( $T_a=25^{\circ}\text{C}$ ,  $V_{cc}=5\text{V}$ , See Electrical Characteristics Test Circuit)

No.	Symbol	Item	Conditions	Min	Typ	Max	Unit
1	Icc	Current consumption	Current value of Vcc1 and Vcc2 AGC CONT = 1.5V	45	50	65	mA
2	MAX	Min. value of AGC MAX	GAIN between DATA input and AGC OUT DATA input = 100mV AGC MAX = 4V, AGC CONT = 1.5V	-	18	20	dB
3	AG1	Min. value of AGC CONT	GAIN between DATA input and AGC OUT DATA input = 500mV, AGC CONT = 5V	-	1	4	dB
4	AG2	Max. value of AGC CONT	GAIN between DATA input and AGC OUT DATA input = 30mV, AGC CONT = 1.5V	30	32	-	dB
5	AG3	AGC CONT 10dB	GAIN between DATA input and AGC OUT DATA input = 320mV, AGC CONT = 3.55V	8	10	12	dB
6	ADC	AGC OUT DC	DC output level of AGC OUT	2.25	2.55	2.85	V
7	$\gamma 1$	$\gamma 1$ output level	Test value of $\gamma 1$ output level $\gamma$ IN input = 500mV	530	630	730	mV
8	$\gamma 2$	$\gamma 2$ output level	Test value of $\gamma 2$ output level $\gamma$ IN input = 500mV, S9 ON	580	680	780	mV
9	LG	LINEAR AMP GAIN	GAIN between $\gamma$ IN input level and LINEAR $\gamma$ IN input = 500mV	1.5	2.6	3.5	dB
10	DDC	DET OUT DC	DC output level of DET OUT	1.8	2.0	2.2	V
11	IG	IRIS AMP GAIN	GAIN between DATA input and IRIS DATA input = 300mV	8	10	12	dB
12	IDC	IRIS OUT DC	DC output level of IRIS	1.1	1.3	1.5	V
13	DG	DRIVER GAIN	GAIN between DRIVER IN and VIDEO DRIVER IN = 700mV	5.7	6.0	6.3	dB
14	SY	SYNC level	SYNC level / DG* of VIDEO output	270	293	316	mV
15	DC1	Dark clip 1	Dark clip level of preset mode 1 Dark clip level / DG* of VIDEO output	-15	0	15	mV
16	DC2	Dark clip 2	Dark clip level of preset mode 2 Dark clip level / DG* of VIDEO output	0	20	40	mV
17	DC3	Min. value of DC CONT	Dark clip level / DG* of VIDEO output DC CONT = 2V	-	-3	15	mV
18	DC4	Max. value of DC CONT	Dark clip level / DG* of VIDEO output DC CONT = 3.3V	80	130	-	mV
19	WC1	W-CLIP level	W-CLIP level / DG* of VIDEO output DRIVER IN = 1500mV, WC CONT = GND	780	820	860	mV
20	WC2	Min. value of WC CONT	W-CLIP level / DG* of VIDEO output DRIVER IN = 1500mV, WC CONT = 2.2V	-	300	600	mV
21	WC3	Max. value of WC CONT	W-CLIP level / DG* of VIDEO output DRIVER IN = 1500mV, WC CONT = 3.3V	1000	1300	-	mV
22	OPL	OP AMP output D range Low level	DC output level of OP OUT OP IN+ = 2.5V, OP IN- = 4V	-	0.8	1.2	V
23	OPH	OP AMP output D range High level	DC output level of OP OUT OP IN+ = 4V, OP IN- = 2.5V	4.5	4.8	-	V

\*Characteristics value at DRIVER GAIN item

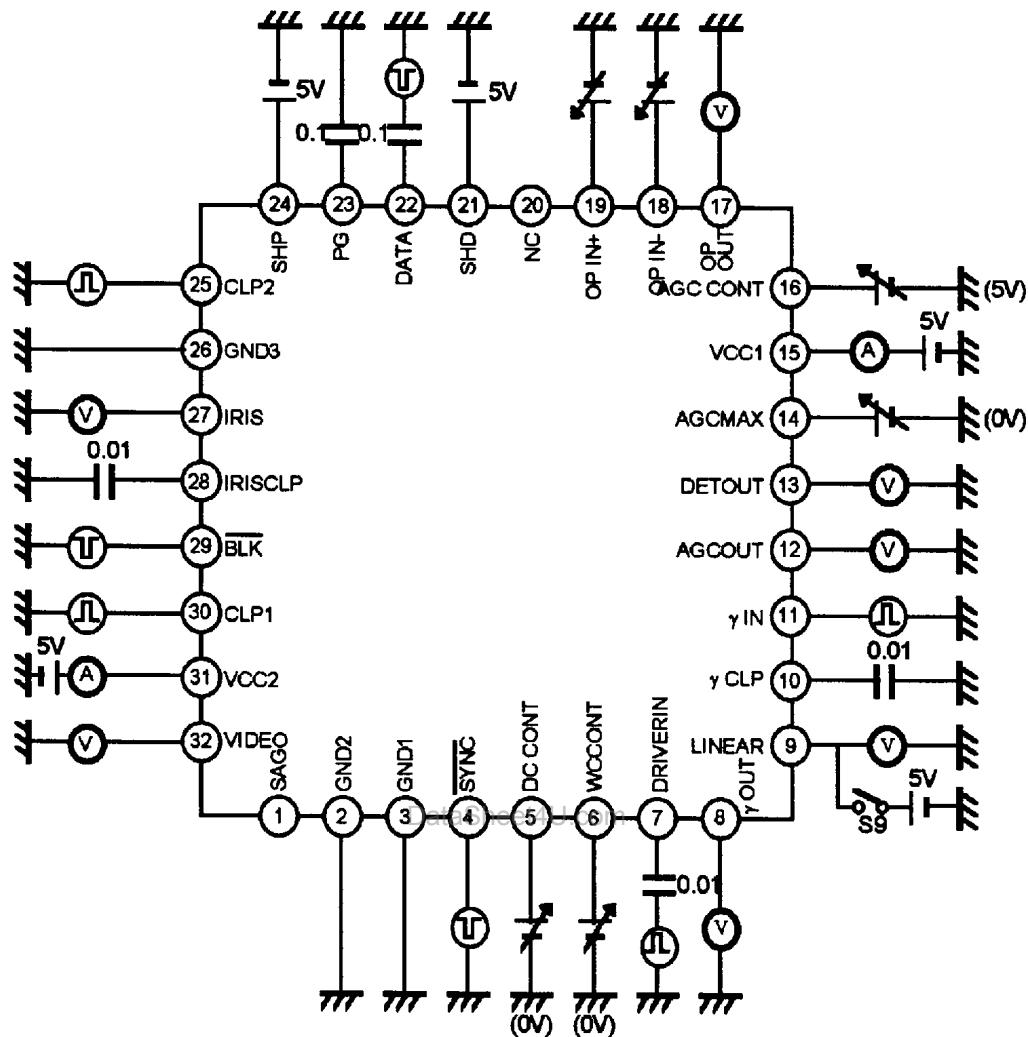
**Electrical Characteristics Test Circuit**

**Note )**

- $\mu\text{F}$  is the capacitance unit of capacitor
- For Pins 5,6,14 and16 apply voltage in brackets unless otherwise specified in the conditions column of the Electrical Characteristics.
- $\text{\textcircled{V}}$  indicate a test pin. (Test AC, DC voltage)
- For Pins 7,11 and 22, the input signal level is at 0mV, unless otherwise specified in the conditions column of the Electrical Characteristics.

### Test Circuit I/O Waveform Diagram

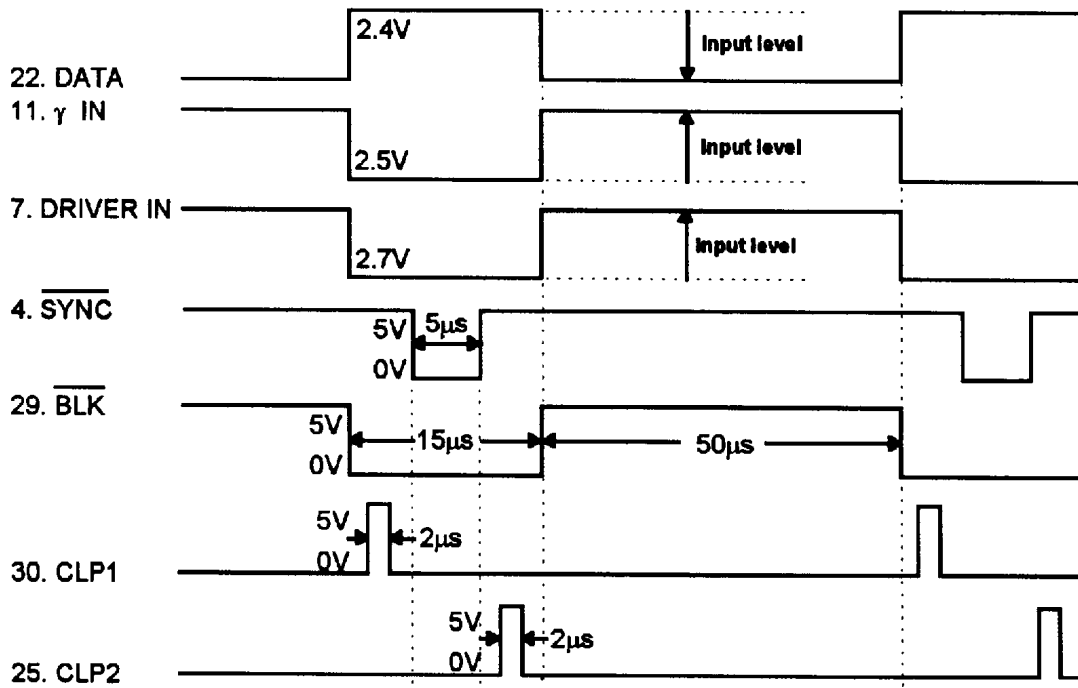
#### Input pin



#### Output pin

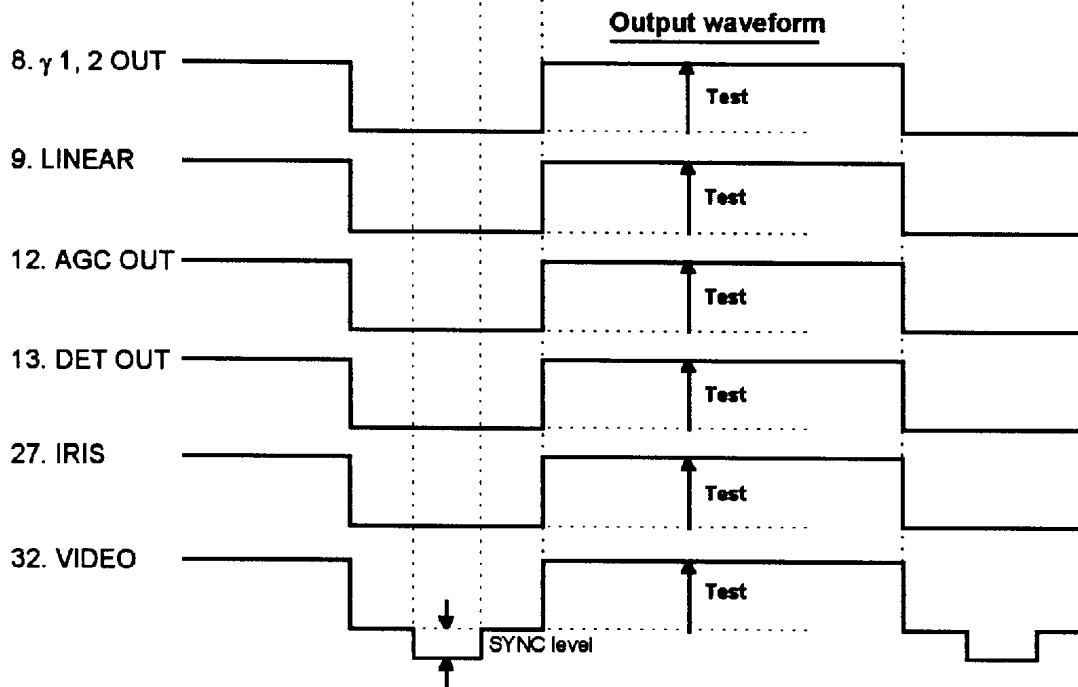

## Application Circuit

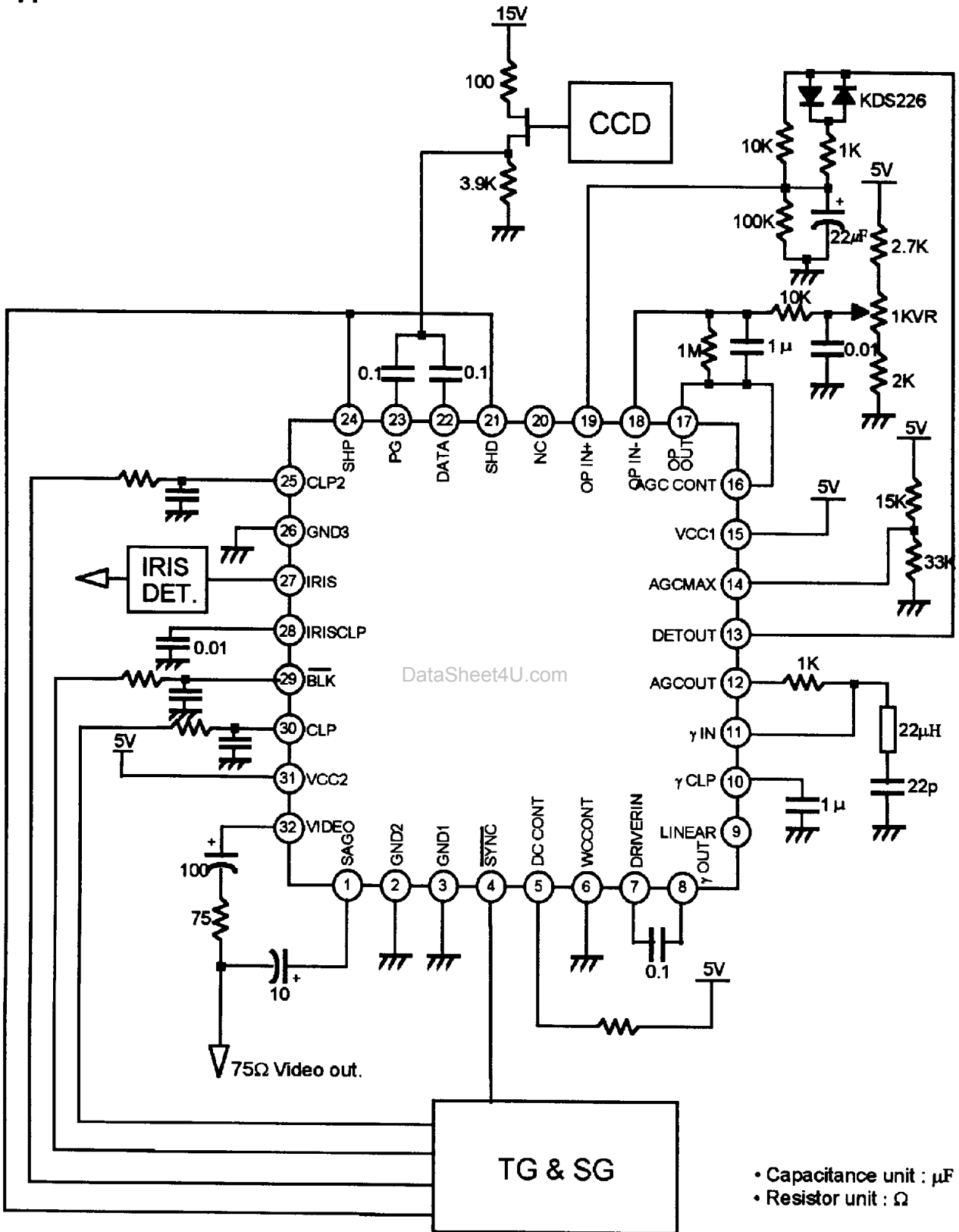

et4U.com

DataSheet4U.com

DataShee

**Characteristic Curve (V<sub>cc</sub>=5V, T<sub>a</sub>=25°C)**

**Fig.1 - AGC control characteristics**

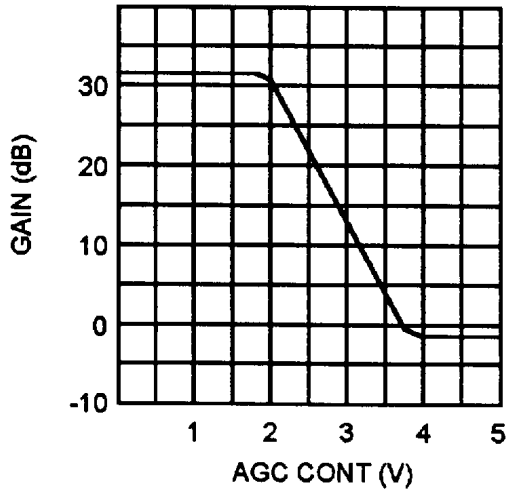

**Fig.2 - AGC MAX control characteristics**

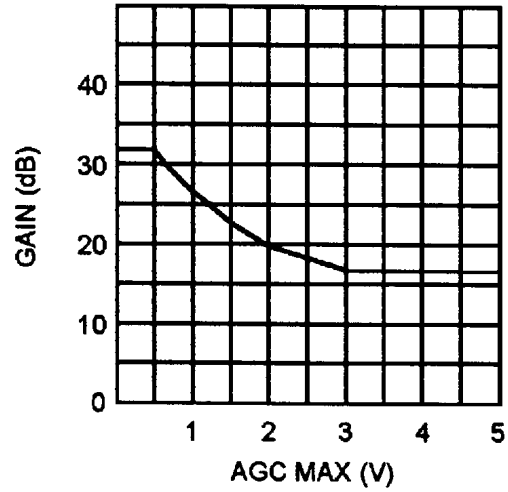

**Fig.3A -  $\gamma$ 1 I/O characteristics**

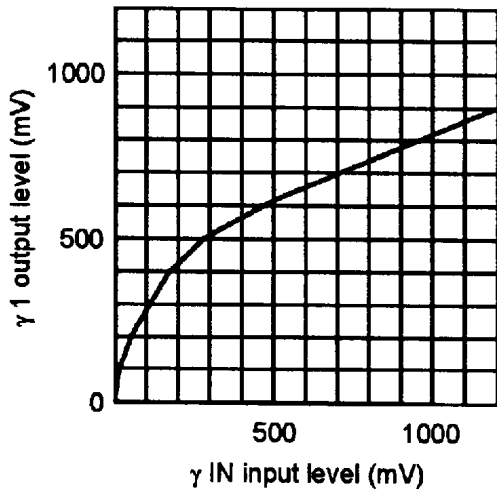

**Fig.3B -  $\gamma$ 2 I/O characteristics**

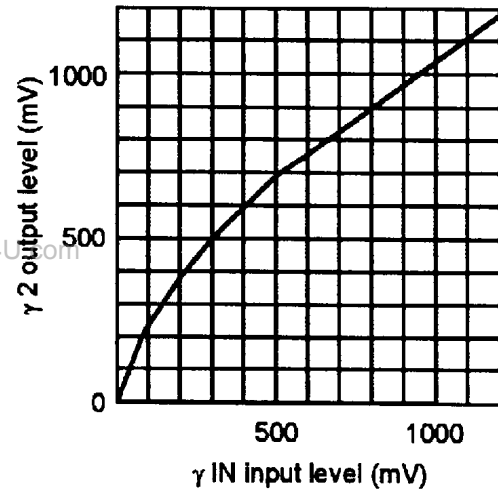

**Fig.4 - White Clip control characteristics**

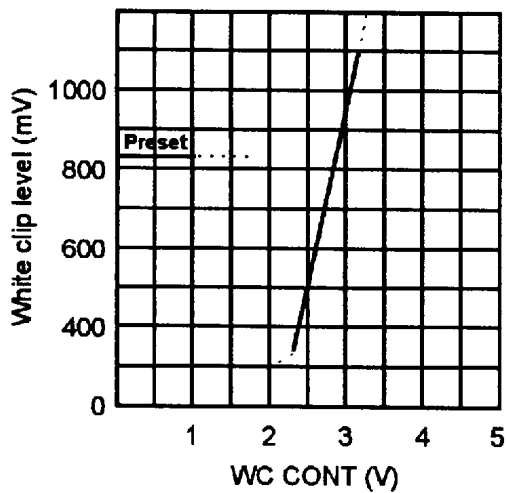

**Fig.5 - Dark clip control characteristics**

