

GDM-4011P

SERVICE MANUAL REVISED

N.Hemisphere Model
S.Hemisphere Model

No. SCC-L03B-A

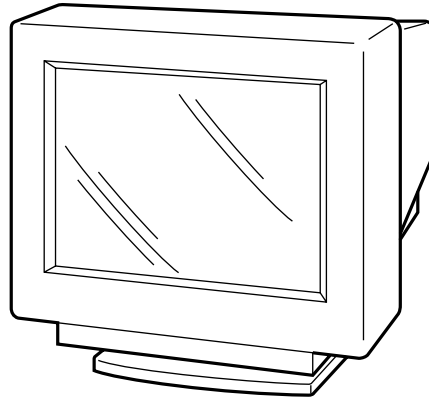

N3 CHASSIS

SPECIFICATIONS

Picture tube	0.31 mm phosphor trio pitch 20 inches measured diagonally 90-degree deflection	Deflection frequency	Horizontal: 30 to 96 kHz Vertical: 48 to 160 Hz
Viewable image size	Approx. 387 × 292 mm (w/h) (15 ¹ / ₄ × 11 ¹ / ₂ inches) 19.0" viewing image	AC input voltage / current	100 to 240 V, 50 – 60 Hz, 1.7 – 1.2 A
Resolution	Horizontal: Max. 1600 dots Vertical: Max. 1200 lines	Power consumption	Max. 150 W
Standard image area	Approx. 373 × 280 mm (w/h) (14 ³ / ₄ × 11 ¹ / ₈ inches) or Approx. 350 × 280 mm (w/h) (13 ⁷ / ₈ × 11 ¹ / ₈ inches)	Dimensions	472 × 490 × 500 mm (w/h/d) (18 ⁵ / ₈ × 19 ³ / ₈ × 19 ³ / ₄ inches)
		Mass	Approx. 28 kg (61 lb 7 oz)
		Design and specifications are subject to change without notice.	

COLOR GRAPHIC DISPLAY
SiliconGraphics

POWER SAVING FUNCTION

This monitor is capable of three states of reduced power consumption. By sensing the absence of video signals and one or both sync signals coming from the host computer, it will reduce power consumption as follows.

Power consumption state	Power consumption	Recovery time	⏻ power indicator
1 Normal operation	≤140 W	–	Green on
2 Standby (1st state) –	≤100 W	Approx. 1 sec.	Green and orange alternate
3 Suspend (2nd state) –	≤15 W	Approx. 3 sec.	Green and orange alternate
4 Active-off (3rd state) –	≤5 W	Approx. 15 sec.	Orange on
5 Power-off –	0 W	–	Off

DIAGNOSIS

Failre	Power LED
+B failure	Yellow → Off (0.5 sec) (0.5 sec)
Horizontal / Vertical Deflection failure, Thermal protector	Yellow → Off (1.5 sec) (0.5 sec)
ABL protector	Yellow → Off (0.5 sec) (1.5 sec)
HV failure	Yellow → Off → Yellow → Off (0.25 sec) (0.5 sec) (0.25 sec) (1.25 sec)
Aging / Self Test	Yellow → Off → Green → Off (0.5 sec) (0.5 sec) (0.5 sec) (0.5 sec)

Aging Mode (Video Aging) : During Power Save, press “MENU” key for longer than 2 second.

Self Test (OSD Color Bar) : During Power Save, press “CONTRAST” + (➡) key for longer than 2 second.

Reliability Check Mode : During Power Save, press “CONTRAST” – (⬅) key for longer than 2 second.

TIMING SPECIFICATION

MODE	MODE 1	MODE 2	MODE 3	MODE 4	MODE 5	MODE 6	MODE 7	MODE 8	MODE 9	MODE 10
MODE AT PRODUCTION	MODE 1	MODE 2	MODE 3	MODE 4	MODE 5	MODE 6	MODE 7	MODE 8	MODE 9	MODE 10
RESOLUTION	1280 X 1024	1280 X 1024	1280 X 1024	1280 X 1024	1280 X 1024	1024 X 768	1024 X 768	1920 X 1035	1600 X 1200	1280 X 492
CLOCK	135.000 MHz	129.250 MHz	107.250 MHz	89.571 MHz	140.250 MHz	78.750 MHz	63.546 MHz	159.923 MHz	156.200 MHz	107.250 MHz
— HORIZONTAL —										
H-FREQ	79.976 kHz	76.935 kHz	63.839 kHz	53.316 kHz	81.922 kHz	60.023 kHz	48.732 kHz	65.009 kHz	74.808 kHz	63.839 kHz
	usec	usec	usec	usec	usec	usec	usec	usec	usec	usec
H. TOTAL	12.504	12.998	15.664	18.756	12.207	16.660	20.521	15.382	13.367	15.664
H. BLK	3.022	3.095	3.730	4.466	3.080	3.657	4.406	3.377	3.124	3.730
H. FP	0.119	0.248	0.373	0.357	0.228	0.203	1.133	0.275	0.282	0.373
H. SYNC	1.067	1.083	1.119	1.340	1.255	1.219	1.196	0.825	0.768	1.119
H. BP	1.837	1.764	2.238	2.769	1.597	2.235	2.077	2.276	2.074	2.238
H. ACTIV	9.481	9.903	11.935	14.290	9.127	13.003	16.114	12.006	10.243	11.935
— VERTICAL —										
V. FREQ(HZ)	75.025 Hz	72.239 Hz	59.943 Hz	50.062 Hz	75.924 Hz	75.029 Hz	59.940 Hz	60.194 Hz	59.847 Hz	119.999 Hz
	lines	lines	lines	lines	lines	lines	lines	lines	lines	lines
V. TOTAL	1066	1065	1065	1065	1079	800	813	1080	1250	532
V. BLK	42	41	41	41	55	32	45	45	50	40
V. P F	1	3	3	3	3	1	3	3	5	3
V. SYNC	3	3	3	3	3	3	3	10	6	3
V. BP	38	35	35	35	49	28	39	32	39	34
V. ACTIV	1024	1024	1024	1024	1024	768	768	1035	1200	492
— SYNC —										
INT(G)	NO	YES	YES	YES	YES	NO	YES	YES	YES	YES
EXT(H/V)/POLARITY	YES P/P	NO	NO	NO	NO	YES P/P	NO	NO	NO	NO
EXT(CS) /POLARITY	NO	NO	NO	NO	NO	NO	NO	NO	NO	NO
INT/NON INT	NON INT	NON INT	NON INT	NON INT	NON INT	NON INT	NON INT	NON INT	NON INT	NON INT

SAFETY CHECK-OUT (US Model only)

GDM-4011P

After correcting the original service problem, perform the following safety checks before releasing the set to the customer:

1. Check the area of your repair for unsoldered or poorly-soldered connections. Check the entire board surface for solder splashes and bridges.
2. Check the interboard wiring to ensure that no wires are “pinched” or contact high-wattage resistors.
3. Check that all control knobs, shields, covers, ground straps, and mounting hardware have been replaced. Be absolutely certain that you have replaced all the insulators.
4. Look for unauthorized replacement parts, particularly transistors, that were installed during a previous repair. Point them out to the customer and recommend their replacement.
5. Look for parts which, though functioning, show obvious signs of deterioration. Point them out to the customer and recommend their replacement.
6. Check the line cords for cracks and abrasion. Recommend the replacement of any such line cord to the customer.
7. Check the B+ and HV to see if they are specified values. Make sure your instruments are accurate; be suspicious of your HV meter if sets always have low HV.
8. Check the antenna terminals, metal trim, “metallized” knobs, screws, and all other exposed metal parts for AC Leakage. Check leakage as described below.

3. Measuring the voltage drop across a resistor by means of a VOM or battery-operated AC voltmeter. The “limit” indication is 0.75 V, so analog meters must have an accurate low-voltage scale. The Simpson 250 and Sanwa SH-63Trd are examples of a passive VOMs that are suitable. Nearly all battery operated digital multimeters that have a 2 V AC range are suitable. (See Fig. A)

WARNING!!

NEVER TURN ON THE POWER IN A CONDITION IN WHICH THE DEGAUSS COIL HAS BEEN REMOVED.

**SAFETY-RELATED COMPONENT WARNING!!
COMPONENTS IDENTIFIED BY SHADING AND MARK Δ ON THE SCHEMATIC DIAGRAMS, EXPLODED VIEWS AND IN THE PARTS LIST ARE CRITICAL FOR SAFE OPERATION. REPLACE THESE COMPONENTS WITH SONY PARTS WHOSE PART NUMBERS APPEAR AS SHOWN IN THIS MANUAL OR IN SUPPLEMENTS PUBLISHED BY SONY. CIRCUIT ADJUSTMENTS THAT ARE CRITICAL FOR SAFE OPERATION ARE IDENTIFIED IN THIS MANUAL. FOLLOW THESE PROCEDURES WHENEVER CRITICAL COMPONENTS ARE REPLACED OR IMPROPER OPERATION IS SUSPECTED.**

AVERTISSEMENT!!

NE JAMAIS METTRE SOUS TENSION QUAND LA BOBINE DE DEMAGNETISATION EST ENLEVÉE.

ATTENTION AUX COMPOSANTS RELATIFS À LA SÉCURITÉ!!

LES COMPOSANTS IDENTIFIÉS PAR UNE TRAME ET UNE MARQUE Δ SONT CRITIQUES POUR LA SÉCURITÉ. NE LES REMPLACER QUE PAR UNE PIÈCE PORTANT LE NUMÉRO SPECIFIÉ. LES RÉGLAGES DE CIRCUIT DONT L'IMPORTANCE EST CRITIQUE POUR LA SÉCURITÉ DU FONCTIONNEMENT SONT IDENTIFIÉS DANS LE PRÉSENT MANUEL. SUIVRE CES PROCÉDURES LORS DE CHAQUE REMPLACEMENT DE COMPOSANTS CRITIQUES, OU LORSQU'UN MAUVAIS FONCTIONNEMENT EST SUSPECTÉ.

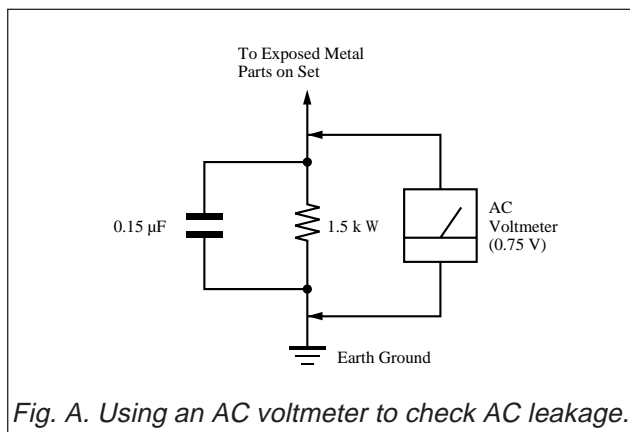

LEAKAGE TEST

The AC leakage from any exposed metal part to earth ground and from all exposed metal parts to any exposed metal part having a return to chassis, must not exceed 0.5 mA (500 microamperes). Leakage current can be measured by any one of three methods.

1. A commercial leakage tester, such as the Simpson 229 or RCA WT-540A. Follow the manufacturers' instructions to use these instruments.
2. A battery-operated AC milliammeter. The Data Precision 245 digital multimeter is suitable for this job.

CAUTION ON DAS (ECS) CONNECTOR

- The connector for DAS (ECS) adjustment is provided inside the cover shown below. Be careful with an electrical shock when connecting the connector with the power supplied. Also, return the removed cover to the home position.

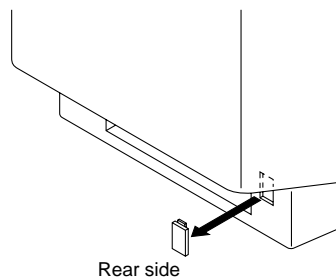

TABLE OF CONTENTS

<u>Section</u>	<u>Title</u>	<u>Page</u>
1. GENERAL	1-1
2. DISASSEMBLY		
2-1.	Cabinet Removal	2-1
2-2.	D Board Removal	2-1
2-3.	G Board Removal	2-2
2-4.	A Board Removal	2-2
2-5.	I/O Terminal Board Assy Removal	2-3
2-6.	Service Position	2-3
2-7.	H and J Boards Removal	2-4
2-8.	Picture Tube Removal	2-4
3. SAFETY RELATED ADJUSTMENT	3-1
4. ADJUSTMENTS	4-1
5. DIAGRAMS		
5-1.	Block Diagrams	5-1
5-2.	Frame Shcematic Diagram	5-7
5-3.	Circuit Boards Location	5-9
5-4.	Schematic Diagrams and Printed Wiring Boards	5-9
	(1) Schematic Diagrams of G, H and J Boards	5-10
	(2) Schematic Diagram of D Board	5-13
	(3) Schematic Diagram of A Board	5-23
5-5.	Semiconductors	5-26
6. EXPLODED VIEWS		
6-1.	Chassis	6-1
6-2.	Picture Tube	6-2
6-3.	Packing Materials	6-3
7. ELECTRICAL PARTS LIST	7-1

Identifying Parts and Controls

See the pages in parentheses for further details.

Front

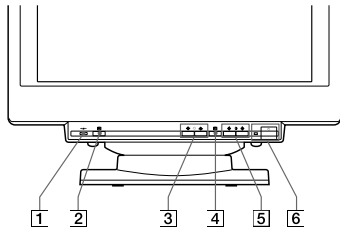

- 1 (reset) button (page 16)
Resets the adjustments to the factory settings.
- 2 (auto sizing and centering) button (page 6)
Automatically adjusts the size and centering of the images.
- 3 (brightness) (/) buttons (pages 7 - 16)
Adjust the picture brightness.
Function as the (/) buttons when adjusting other items.
- 4 (menu) button (pages 7 - 16)
Displays the MENU OSD.
- 5 (contrast) () buttons (pages 7 - 16, 20)
Adjust the contrast.
Function as the () buttons when adjusting other items.
- 6 (power) switch and indicator (pages 17, 20)
Turns the monitor on or off.
The indicator lights up in green when the monitor is turned on, and lights up in orange when the monitor is in power saving mode.

Rear

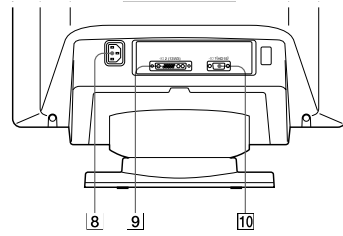

- 8 AC IN connector
Provides AC power to the monitor.
- 9 Video input 2 connector (13W3)
Inputs RGB video signals (0.714 Vp-p, positive) and SYNC signals.

A1:Red
A2:Green
A3:Blue
- Note
If you use a computer or video board of high output level (about 1.0 Vp-p), you may not be able to obtain the optimum display. In such case, try decreasing the picture contrast, or use a computer or video board with a lower output level.
- 10 Video input 1 connector (HD15)
Inputs RGB video signals (0.714 Vp-p, positive) and SYNC signals.

5 4 3 2 1
10 9 8 7 6
15 14 13 12 11

Pin No.	Signal	Pin No.	Signal
1	Red	8	Blue Ground
2	Green (Composite Sync on Green)	9	DDC + 5V*
3	Blue	10	Ground
4	ID (Ground)	11	ID (Ground)
5	DDC Ground*	12	Bi-Directional Data (SDA)*
6	Red Ground	13	H. Sync
7	Green Ground	14	V. Sync
		15	Data Clock(SCL)*

* Display Data Channel (DDC) Standard of VESA

EN

Before adjusting

- Connect the monitor and the computer, and turn them on.
- Select "LANG" in the MENU OSD, then select "ENGLISH" (English) (see page 15).

Adjusting the Picture Brightness and Contrast

Once the setting is adjusted, it will be stored in memory for all input signals received.

- 1 Press the (brightness) or (contrast) buttons.
The BRIGHTNESS/CONTRAST OSD appears.

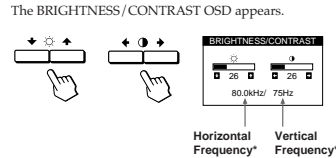

- 2 For brightness adjustment

Press the buttons.

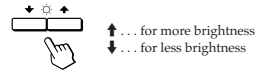

For contrast adjustment

Press the buttons.

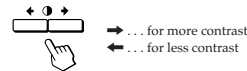

The OSD automatically disappears after about 3 seconds.

To reset, press the (reset) button while the OSD is on. The brightness and contrast are both reset to the factory settings.

* The horizontal and vertical frequencies for the received input signal appear in the BRIGHTNESS/CONTRAST OSD.

Introducing the On-screen Display System

Most adjustments are made using the MENU OSD.

MENU OSD

Press the button to display the MENU OSD.

This MENU OSD contains links to the other OSDs described below.

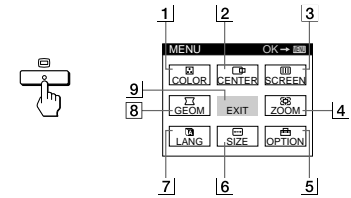

- 1 COLOR
Displays the COLOR OSD for adjusting the color temperature.
- 2 CENTER
Displays the CENTER OSD for adjusting the centering of the picture.
- 3 SCREEN
Displays the SCREEN OSD for adjusting the vertical and horizontal convergence, etc.
- 4 ZOOM
Displays the ZOOM OSD for enlarging and reducing the picture.
- 5 OPTION
Displays the OPTION OSD for adjusting the OSD position and degauss the screen, etc.
- 6 SIZE
Displays the SIZE OSD for adjusting the picture size.
- 7 LANG
Displays the LANGUAGE OSD for selecting the language.
- 8 GEOM
Displays the GEOMETRY OSD for adjusting the picture rotation and pincushion, etc.
- 9 EXIT
Closes the MENU OSD.

Navigating the MENU on-screen display

Select a link using the /↑ and ◀/→ buttons in the MENU OSD.

- 1 Press the button.
The MENU OSD appears.



- 2 Press the /↑ and ◀/→ buttons to select a link.
The selected link turns yellow.

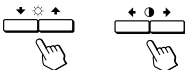

- 3 Press the button.
The selected OSD appears.



If no buttons are pressed, the MENU OSD automatically disappears after about 10 seconds.
To close the MENU OSD, select "EXIT" and press the button.

Adjusting the on-screen display settings

Select an item using the /↑ buttons and adjust or select the setting of that item using the ◀/→ buttons.

- To select an item, press the /↑ or ↑ button.
The ▶ mark goes to the selected item and the item turns yellow.



- To adjust or set an item, press the ◀/→ button.
When adjusting an item, the bar length and the figure increase or decrease.
When setting an item, the ■ mark turns green.



Using the CENTER On-screen Display

The CENTER settings allow you to adjust the centering of the picture.
Once the setting is adjusted, it will be stored in memory for the current input signal.

- 1 Press the button.
The MENU OSD appears.



- 2 Press the /↑ and ◀/→ buttons to select "CENTER," and press the button again.
The CENTER OSD appears.

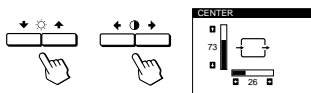

- 3 For horizontal adjustment
Press the ◀/→ buttons.

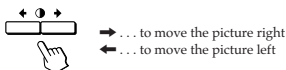

- For vertical adjustment
Press the /↑ buttons.

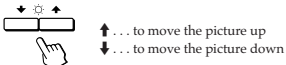

The OSD automatically disappears after about 30 seconds.
To close the OSD, press the button again.

To reset, press the (reset) button while the OSD is on.
The horizontal and vertical centerings are both reset to the factory settings.

Using the SIZE On-screen Display

The SIZE settings allow you to adjust the size of the picture.
Once the setting is adjusted, it will be stored in memory for the current input signal.

- 1 Press the button.
The MENU OSD appears.



- 2 Press the /↑ and ◀/→ buttons to select "SIZE," and press the button again.
The SIZE OSD appears.

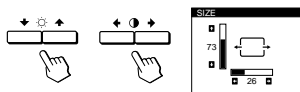

- 3 For horizontal adjustment
Press the ◀/→ buttons.

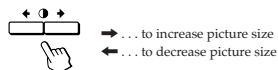

- For vertical adjustment
Press the /↑ buttons.

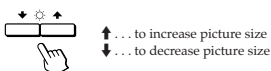

The OSD automatically disappears after about 30 seconds.
To close the OSD, press the button again.

To reset, press the (reset) button while the OSD is on.
The horizontal and vertical sizes are both reset to the factory settings.

Using the GEOM (Geometry) On-screen Display

The GEOM(geometry) settings allow you to adjust the shape and orientation of the picture.
Once the rotation is adjusted, it will be stored in memory for all input signals received. All other adjustments will be stored in memory for the current input signal.

- 1 Press the button.
The MENU OSD appears.



- 2 Press the /↑ and ◀/→ buttons to select "GEOM," and press the button again.
The GEOMETRY OSD appears.

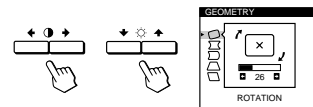

- 3 Press the /↑ buttons to select the item you want to adjust.



Select	To
ROTATION	adjust the picture rotation
PINCUSHION	adjust the picture sides
PIN BALANCE	adjust the picture side balance
KEYSTONE	adjust the picture width
KEY BALANCE	adjust the picture shape balance

4 Press the buttons to adjust the settings.



For	Press
ROTATION	<p> ... to rotate the picture clockwise</p> <p> ... to rotate the picture counterclockwise</p>
PINCUSHION	<p> ... to expand the picture sides</p> <p> ... to contract the picture sides</p>
PIN BALANCE	<p> ... to move the picture sides to the right</p> <p> ... to move the picture sides to the left</p>
KEYSTONE	<p> ... to increase the picture width at the top</p> <p> ... to decrease the picture width at the top</p>
KEY BALANCE	<p> ... to move the top of the picture to the right</p> <p> ... to move the top of the picture to the left</p>

The OSD automatically disappears after about 30 seconds. To close the OSD, press the button again.

To reset, press the (reset) button while the OSD is on. The selected item is reset to the factory setting.

Using the ZOOM On-screen Display

The ZOOM settings allow you to enlarge or reduce the picture. Once the setting is adjusted, it will be stored in memory for the current input signal.

- 1 Press the button. The MENU OSD appears.



- 2 Press the and buttons to select "ZOOM," and press the button again. The ZOOM OSD appears.

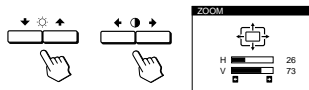

- 3 Press the buttons to adjust the picture zoom.

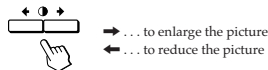

The OSD automatically disappears after about 30 seconds. To close the OSD, press the button again.

Note

The picture zoom adjustment will stop as soon as either the horizontal or vertical size reaches its maximum or minimum value.

EN

Using the COLOR On-screen Display

You can change the monitor's color temperature. For example, you can change the colors of a picture on the screen to match the actual colors of the printed picture. Once the setting is adjusted, it will be stored in memory for all input signals received.

- 1 Press the button. The MENU OSD appears.



- 2 Press the and buttons to select "COLOR," and press the button again. The COLOR OSD appears.

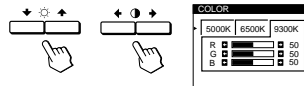

- 3 Press the buttons to select the color temperature.



There are three color temperature modes in the OSD. The preset adjustments are: 5000K, 6500K, 9300K

Fine tune the color temperature

Press the buttons to select R (red), G (green), or B (blue) and adjust by pressing the buttons.

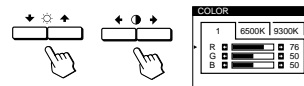

The "5000K," "6500K" or "9300K" disappears and the new color settings are memorized for each of the three color modes. The color temperature modes change as follows: 5000K → 1, 6500K → 2, 9300K → 3

The OSD automatically disappears after about 30 seconds. To close the OSD, press the button again.

To reset, press the (reset) button while the OSD is on. The selected color temperature is reset to the factory settings.

Using the SCREEN On-screen Display

Adjust convergence settings to eliminate red or blue shadows that may appear around objects on the screen. Adjust the CANCEL MOIRE function to eliminate wavy or elliptical lines that may appear on the screen. Once CANCEL MOIRE is adjusted, it will be stored in memory for the current input signal. All other adjustments will be stored in memory for all input signals received.

- 1 Press the button. The MENU OSD appears.



- 2 Press the and buttons to select "SCREEN," and press the button again. The SCREEN OSD appears.

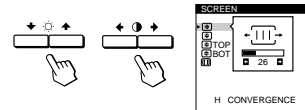

- 3 Press the buttons to select the item you want to adjust.



Select	To
H	adjust the horizontal convergence
H CONVERGENCE	
V	adjust the vertical convergence
V CONVERGENCE	
TOP	adjust the screen's upper vertical convergence
V CONVER TOP	
BOT	adjust the screen's lower vertical convergence
V CONVER BOTTOM	
MOIRE	eliminate elliptical or wavy lines on the screen
ADJ •	adjust the degree of moire cancellation
MOIRE ADJUST	

* CANCEL MOIRE must be "ON" for ADJ (MOIRE ADJUST) to appear on the screen.

4 Press the buttons to adjust the settings.



For	Press
H CONVERGENCE	<p>→ ... to shift red shadows to the right and blue shadows to the left</p> <p>← ... to shift red shadows to the left and blue shadows to the right</p>
V CONVERGENCE	<p>→ ... to shift red shadows up and blue shadows down</p> <p>← ... to shift red shadows down and blue shadows up</p>
TOP V CONVERT TOP	<p>→ ... to shift red shadows up and blue shadows down</p> <p>← ... to shift red shadows down and blue shadows up</p>
BOT V CONVERT BOTTOM	<p>→ ... to shift red shadows up and blue shadows down</p> <p>← ... to shift red shadows down and blue shadows up</p>
CANCEL MOIRE	<p>→ ... to turn CANCEL MOIRE "ON"</p> <p>← ... to turn CANCEL MOIRE "OFF"</p>
ADJ MOIRE ADJUST	<p>→ ... to increase the moire cancellation effect</p> <p>← ... to decrease the moire cancellation effect</p>

The OSD automatically disappears after about 30 seconds. To close the OSD, press the button again.

To reset, press the (reset) button while the OSD is on. The selected item is reset to the factory setting.

Using the OPTION On-screen Display

The OPTION OSD allows you to manually degauss the screen and adjust settings such as the OSD position and power saving delay time. It also allows you to lock the controls.

Degaussing the screen

The monitor screen is automatically degaussed (demagnetized) when the power is turned on. You can also manually degauss the monitor.

- 1 Press the button. The MENU OSD appears.



- 2 Press the and buttons to select "OPTION," and press the button again. The OPTION OSD appears.

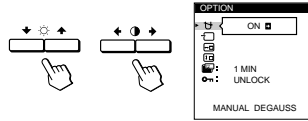

- 3 Press the buttons to select " (MANUAL DEGAUSS)." EN



- 4 Press the button. The screen is degaussed for about 2 seconds.



If you need to degauss the screen a second time, wait for at least 20 minutes before repeating the steps above.

The OPTION OSD automatically disappears after about 30 seconds.

To close the OSD, press the button again.

Changing the on-screen display position

You can change the OSD position (for example, when you want to adjust the picture behind the OSD).

- 1 Press the button. The MENU OSD appears.



- 2 Press the and buttons to select "OPTION," and press the button again. The OPTION OSD appears.

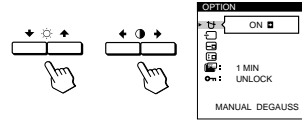

- 3 Press the buttons to select " (OSD H POSITION)" or " (OSD V POSITION)." Select " (OSD H POSITION)" to adjust the horizontal position.

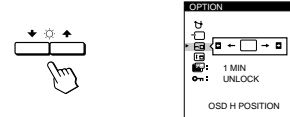

Select " (OSD V POSITION)" to adjust the vertical position.

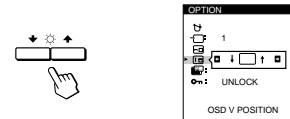

- 4 Press the buttons to move the OSD to the desired position.



The OPTION OSD automatically disappears after about 30 seconds.

To close the OSD, press the button again.

To reset, press the (reset) button while the OSD is on.

Setting the power saving delay time

You can set the delay time before the monitor enters the power saving mode. See page 17 for more information on this monitor's power saving capabilities.

- 1 Press the button. The MENU OSD appears.



- 2 Press the and buttons to select "OPTION," and press the button again. The OPTION OSD appears.

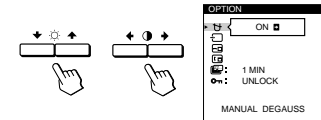

- 3 Press the buttons to select " (PWR SAVE DELAY)." EN

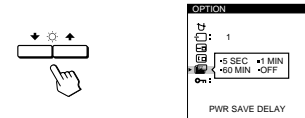

- 4 Press the buttons to select the desired time.





When PWR SAVE DELAY is set to "OFF," the monitor does not go into power saving mode.

The OPTION OSD automatically disappears after about 30 seconds.

To close the OSD, press the button again.



To reset, press the (reset) button while the OSD is on.

Locking the controls



The control lock function disables all of the buttons on the front panel except the  (power) switch and the  button.

- 1 Press the  button. The MENU OSD appears.

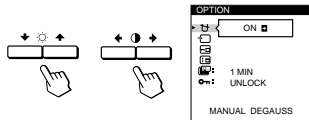

- 2 Press the  and  buttons to select "OPTION," and press the  button again. The OPTION OSD appears.



- 3 Press the  and  buttons to select "CONTROL LOCK)"

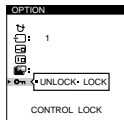



- 4 Press the  buttons to select "LOCK."



The OPTION OSD automatically disappears after about 30 seconds.

To close the OSD, press the  button again.

Once you select "LOCK," you cannot select any items except "EXIT" and "OPTION" in the MENU OSD. If you press any button other than the  (power) switch and the  button, the  mark appears on the screen.

To cancel the control lock



Repeat steps 1 through 3 above and press the  buttons to select "UNLOCK."

Using the LANG (Language) On-screen Display

English, French, German, Spanish and Japanese versions of the OSDs are available.

- 1 Press the  button. The MENU OSD appears.



- 2 Press the  and  buttons to select "LANG," and press the  button again. The LANGUAGE OSD appears.

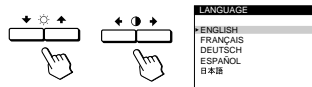



EN

- 3 Press the  and  buttons to select the desired language.





ENGLISH: English, FRANÇAIS: French, DEUTSCH: German, ESPAÑOL: Spanish, or 日本語: Japanese.

The OSD automatically disappears after about 30 seconds. To close the OSD, press the  button again.

To reset to English, press the  (reset) button while the OSD is on.

Resetting the Adjustments

Resetting an adjustment item

- 1 Press the , , and  buttons to select the OSD containing the item you want to reset.

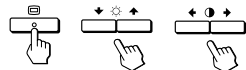

- 2 Press the  buttons to select the item you want to reset.



- 3 Press the  (reset) button.



Resetting all of the adjustment data for the current input signal

When there is no OSD displayed, press the  (reset) button.

All of the adjustments data for the current input signal is reset to the factory settings. Note that adjustment data not affected by changes in input signal (OSD language, OSD position, input signal selection, power saving delay time and the control lock function) is not reset to the factory settings.



Resetting all of the adjustment data for all input signals

Press and hold the  (reset) button for more than two seconds.

All of the adjustment data, including the brightness and contrast, is reset to the factory settings.



Preset Modes

Factory adjusted Timing Modes

Mode	Resolution (dots × lines)	Horizontal Frequency	Vertical Frequency
1	1280 × 1024	80.0 kHz	75 Hz
2	1280 × 1024	76.9 kHz	72 Hz
3	1280 × 1024	63.8 kHz	60 Hz
4	1280 × 1024	81.9 kHz	76 Hz

Data Loaded Timing Modes

Mode	Resolution (dots × lines)	Horizontal Frequency	Vertical Frequency
1	640 × 480	31.5 kHz	60 Hz
2	640 × 480	37.5 kHz	75 Hz
3	640 × 480	43.3 kHz	85 Hz
4	640 × 480	31.5 kHz	70 Hz
5	720 × 400	37.9 kHz	85 Hz
6	800 × 600	37.9 kHz	60 Hz
7	800 × 600	46.9 kHz	75 Hz
8	800 × 600	53.7 kHz	85 Hz
9	1024 × 768	48.4 kHz	60 Hz
10	1024 × 768	56.5 kHz	70 Hz
11	1024 × 768	60.0 kHz	75 Hz
12	1024 × 768	68.7 kHz	85 Hz
13	1152 × 864	67.5 kHz	75 Hz
14	1280 × 960	60.0 kHz	60 Hz
15	1280 × 960	85.9 kHz	85 Hz
16	1280 × 1024	64.0 kHz	60 Hz
17	1280 × 1024	80.0 kHz	75 Hz
18	1280 × 1024	91.1 kHz	85 Hz
19	1600 × 1200	75.0 kHz	60 Hz
20	1600 × 1200	81.3 kHz	65 Hz
21	1600 × 1200	87.5 kHz	70 Hz
22	1600 × 1200	93.8 kHz	75 Hz
23	1280 × 1024	53.3 kHz	50 Hz
24	1024 × 768	48.7 kHz	60 Hz
25	1920 × 1035	65.0 kHz	60 Hz
26	1600 × 1200	74.8 kHz	60 Hz
27	1280 × 492	63.8 kHz	120 Hz

Warning Messages

If there is something wrong with the input signal, one of the following messages appears.
The message disappears after about 30 seconds.

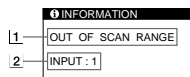

1 The input signal condition

“OUT OF SCAN RANGE” indicates that the input signal is not supported by the monitor’s specifications.

“NO INPUT SIGNAL” indicates that no signal is input, or the input signal from the selected input connector is not received.





2 The selected input connector

Indicates which input connector is receiving the wrong signal. If there is something wrong with the signal from both input connectors, “1” (HD15) and “2” (13W3) are displayed alternately.

To solve these problems, see “Troubleshooting” below.

Troubleshooting

This section may help you isolate the cause of a problem and as a result, eliminate the need to contact technical support.

Symptom	Check these items
No picture	
If the  indicator is not lit	<ul style="list-style-type: none"> • Check that the power cord is properly connected. • Check that the  (power) switch is in the “on” position.
If the “NO INPUT SIGNAL” message appears on the screen, or if the  indicator is either orange or alternating green and orange	<ul style="list-style-type: none"> • Try pressing any key on the computer keyboard. • Check that your computer power switch is in the “on” position. • Check that the input select setting is correct. • Check that the video signal cable is properly connected and all plugs are firmly seated in their sockets. • Ensure that no pins are bent or pushed in the HD15 or 13W3 video input connector.
If the “OUT OF SCAN RANGE” message appears on the screen	<ul style="list-style-type: none"> • Check that the video frequency range is within that specified for the monitor. (Horizontal: 30 – 96 kHz, Vertical: 48 – 160 Hz) • Refer to your computer’s instruction manual to adjust the video frequency range. • If you are using a video signal cable adapter, check that it is correct.
If no message is displayed and the  indicator is green or flashing orange	<ul style="list-style-type: none"> • See “Self-diagnosis Function” (page 20).
Picture is scrambled	<ul style="list-style-type: none"> • Check your graphics board manual for the proper monitor setting. • Check this manual and confirm that the graphics mode and the frequency you are trying to operate at is supported. Even if the frequency is within the proper range, some video boards may have a sync pulse that is too narrow for the monitor to sync correctly.
Color is not uniform	<ul style="list-style-type: none"> • Degauss the monitor (page 13). If you place equipment which generates a magnetic field, such as a loudspeaker, near the monitor, or you change the direction of the monitor, color may lose uniformity. The degauss function demagnetizes the metal frame of the CRT to obtain a neutral field for uniform color reproduction. If a second degauss cycle is needed, allow a minimum interval of 20 minutes for the best result.

Symptom	Check these items
You cannot adjust the monitor with the buttons on the front panel	<ul style="list-style-type: none"> • If the control lock function is set to on, set it to off using the OPTION OSD (page 15).
White does not look white	<ul style="list-style-type: none"> • Adjust the color temperature (page 12).
Screen image is not centered or sized properly	<ul style="list-style-type: none"> • Adjust the size or centering (pages 9 – 10). • Some video modes do not fill the screen to the edges. This problem tends to occur with certain video boards.
Edges of the image are curved	<ul style="list-style-type: none"> • Adjust the geometry (pages 10 – 11).
White lines show red or blue shadows at edges	<ul style="list-style-type: none"> • Adjust the convergence (pages 12 – 13).
Picture is fuzzy	<ul style="list-style-type: none"> • Adjust the contrast and brightness (page 8). • Degauss the monitor (page 13). If you place equipment which generates a magnetic field, such as a loudspeaker, near the monitor, or you change the direction of the monitor, color may lose uniformity. The degauss function demagnetizes the metal frame of the CRT to obtain a neutral field for uniform color reproduction. If a second degauss cycle is needed, allow a minimum interval of 20 minutes for the best result. • If red or blue shadows appear along the edges of images, adjust the convergence (pages 12 – 13). • If the moire is cancelled, the picture may become fuzzy. Decrease the moire cancellation effect (pages 12 – 13).
Picture bounces or has wavy oscillations	<ul style="list-style-type: none"> • Isolate and eliminate any potential sources of electric or magnetic fields. Common causes for this symptom are electric fans, fluorescent lighting or laser printers. • If you have another monitor close to this monitor, increase the distance between them to reduce the interference. • Try plugging the monitor into a different AC outlet, preferably on a different circuit. • Try the monitor on a different computer in a different room.
Picture is flickering	<ul style="list-style-type: none"> • Set the refresh rate on the computer to obtain the best possible picture by referring to the computer’s manual.
Picture appears to be ghosting	<ul style="list-style-type: none"> • Eliminate the use of video cable extensions and/or video switch boxes if this symptom occurs. Excessive cable length or a weak connection can produce this symptom.
Wavy or elliptical (moire) pattern is visible	<ul style="list-style-type: none"> • Cancel the moire (pages 12 – 13). The moire may be modified depending on the connected computer. • Due to the relationship between resolution, monitor dot pitch and the pitch of some image patterns, certain screen backgrounds sometimes show moire. Change your desktop pattern.
Two fine horizontal lines (wires) are visible	<ul style="list-style-type: none"> • These wires stabilize the vertically striped aperture grille (page 17). This aperture grille allows more light to pass through to the screen giving the Trinitron CRT more color and brightness.
Hum is heard right after the power is turned on	<ul style="list-style-type: none"> • When the power is turned on, the auto-degauss cycle is activated. While the auto-degauss cycle is activated (2 seconds), a hum may be heard. The same hum is heard when the monitor is manually degaussed. This is not a malfunction.

SECTION 2 DISASSEMBLY

GDM-4011P

2-1. CABINET REMOVAL

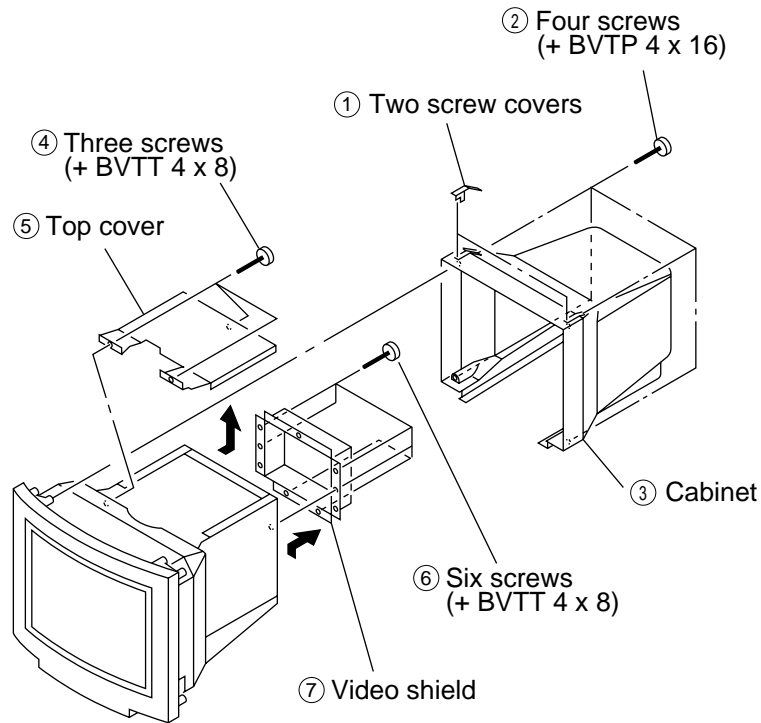

2-2. D BOARD REMOVAL

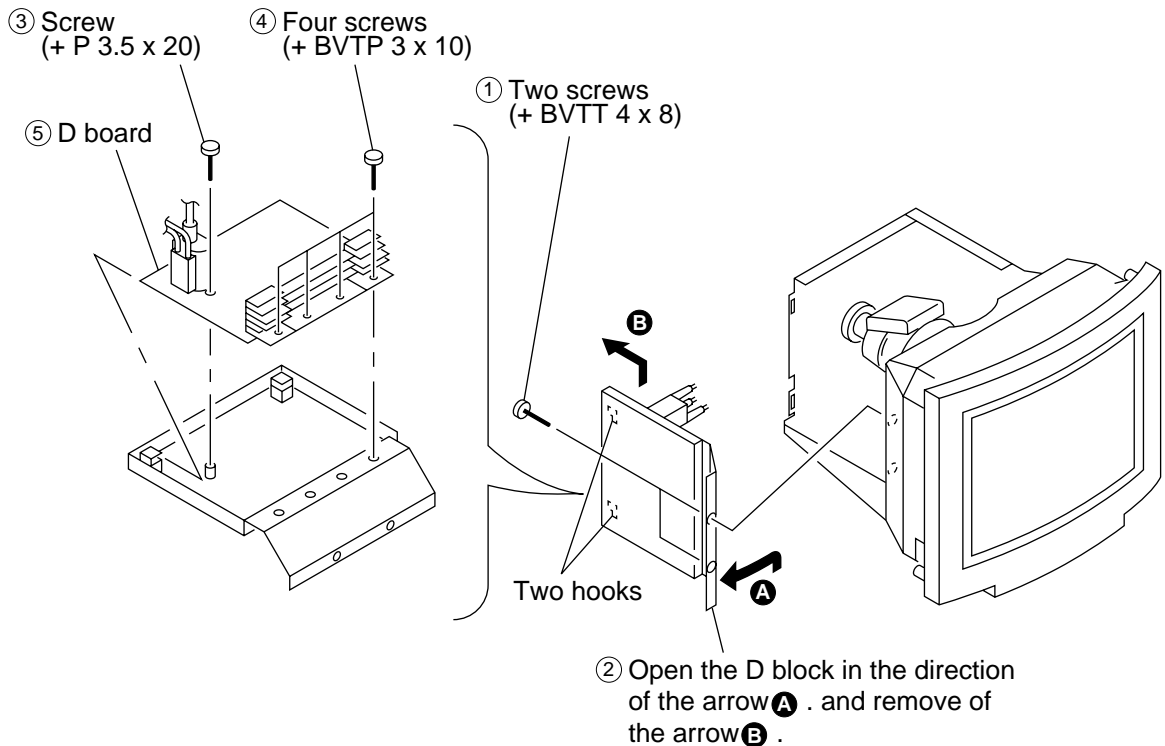

2-3. G BOARD REMOVAL

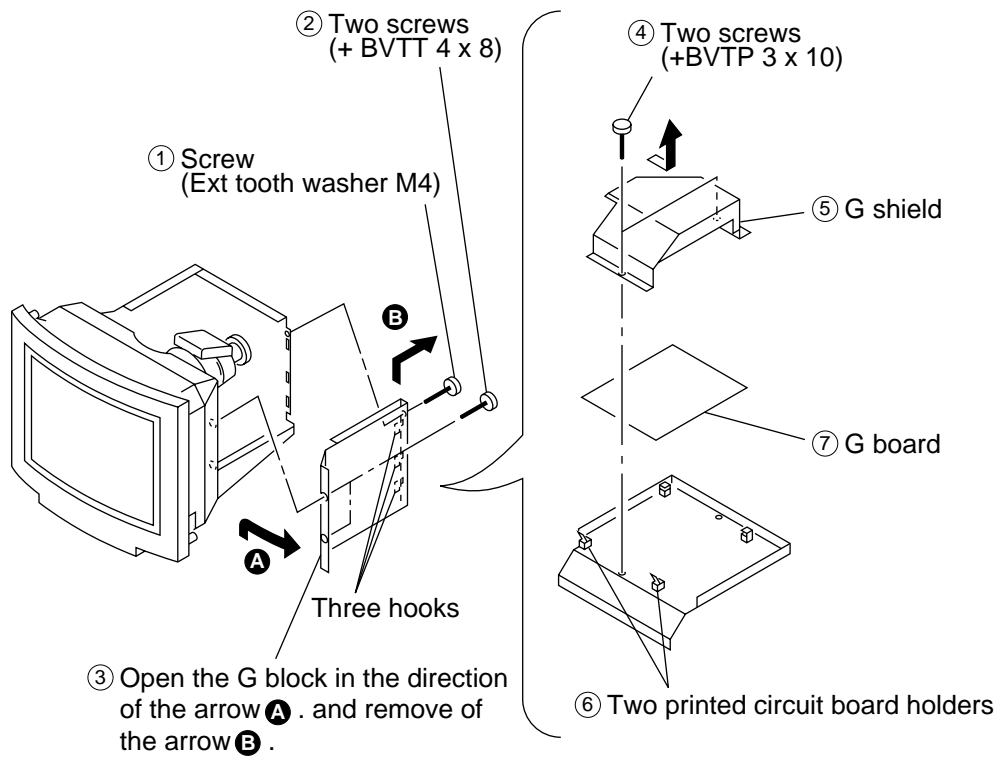

2-4. A BOARD REMOVAL

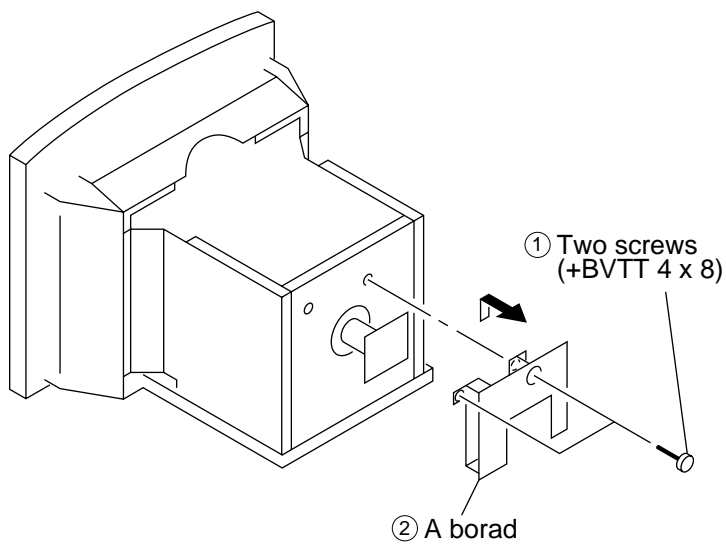

2-5. I/O TERMINAL BOARD ASSY REMOVAL

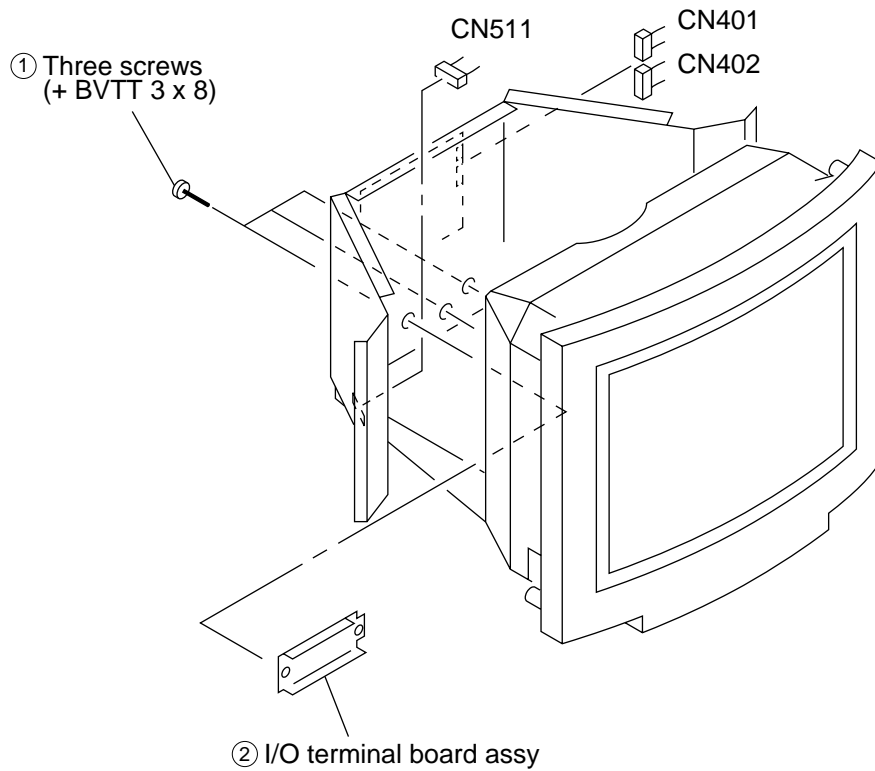

2-6. SERVICE POSITION

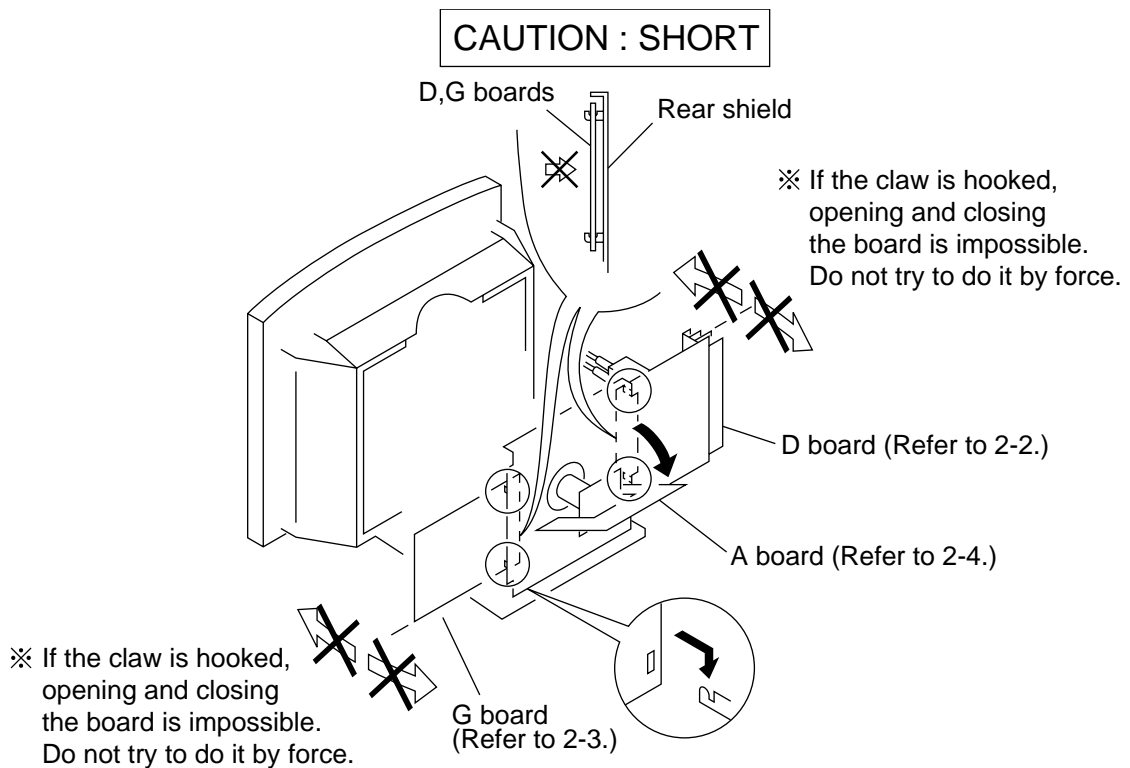

2-7. H AND J BOARDS REMOVAL

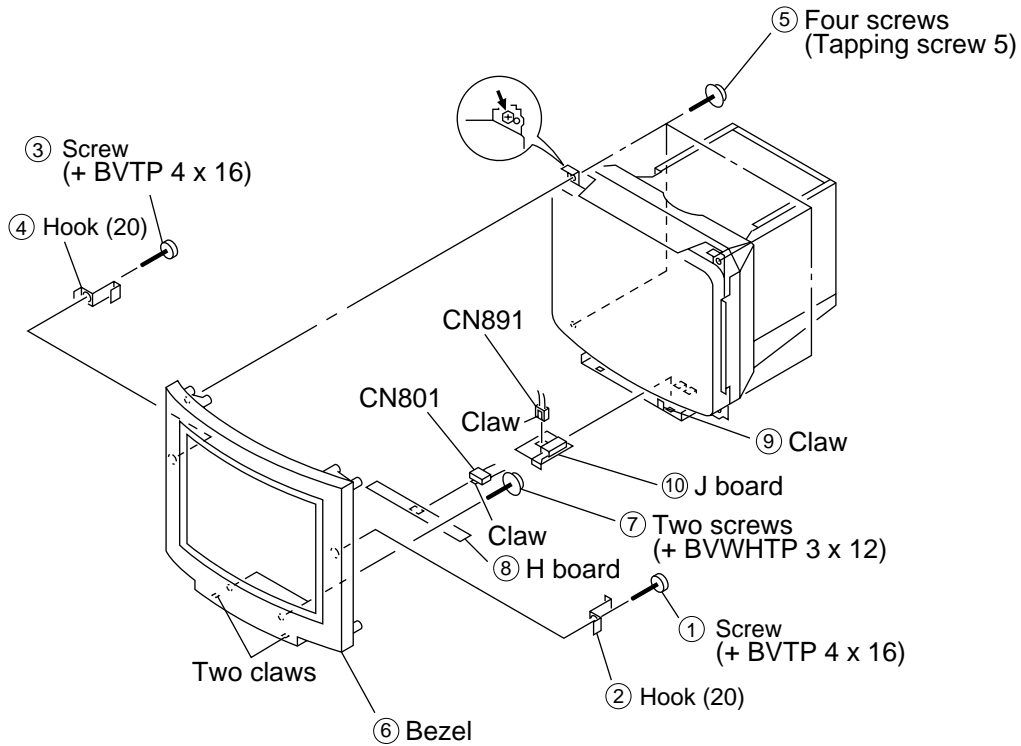

2-8. PICTURE TUBE REMOVAL

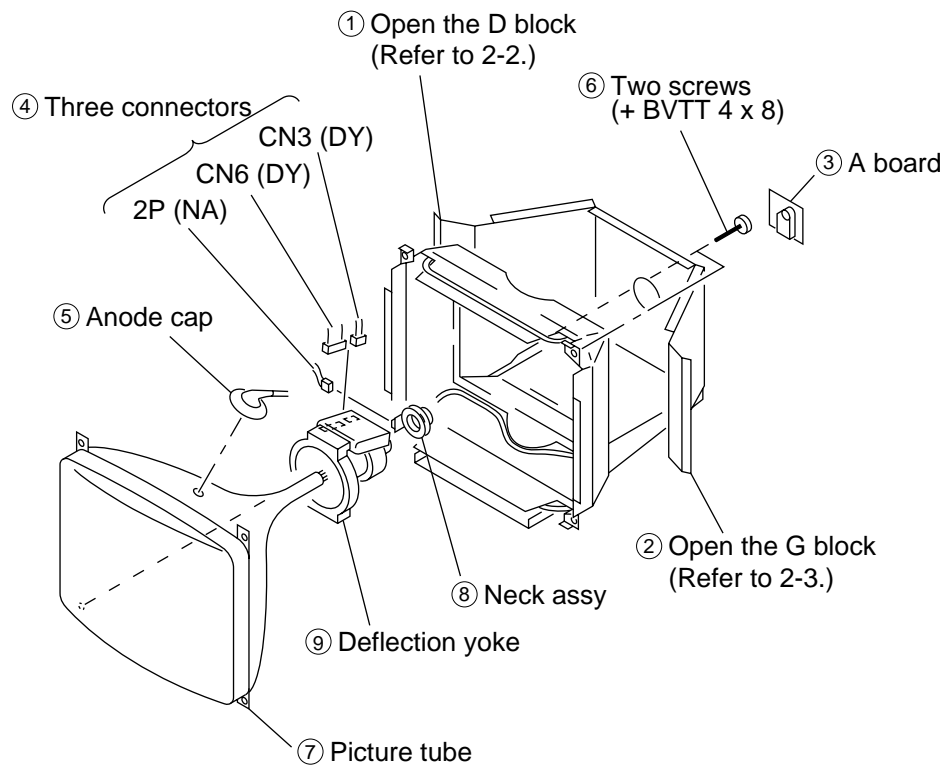

• **INSTALLED POSITION OF THE ANODE-CAP**

Install the anode cap as shown a figure.

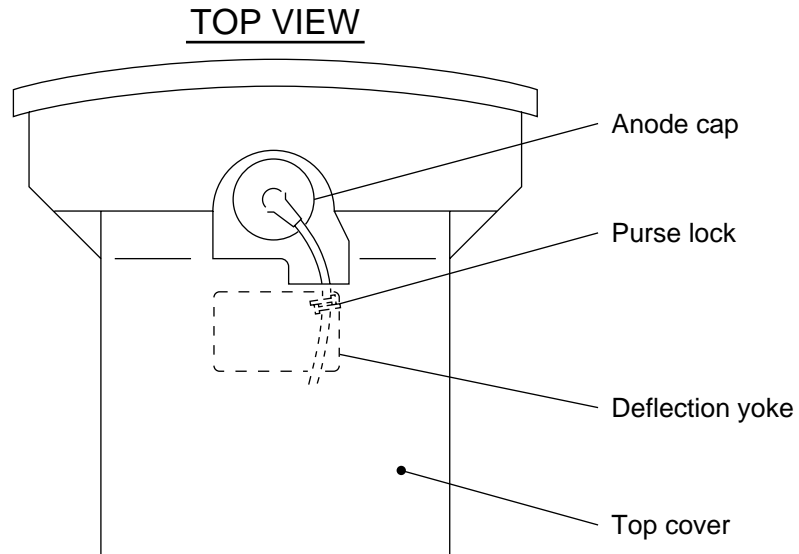

• **REMOVAL OF ANODE-CAP**

NOTE: Short circuit the anode of the picture tube and the anode cap to the metal chassis, CRT shield or carbon painted on the CRT after removing the anode.

• **REMOVING PROCEDURES**

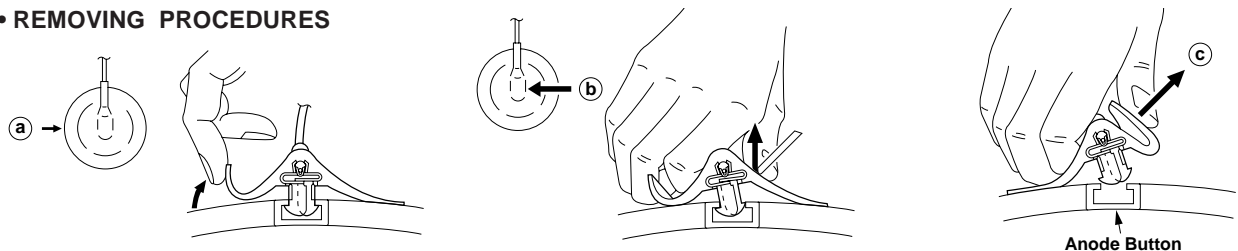

- ① Turn up one side of the rubber cap in the direction indicated by the arrow (a).
- ② Using a thumb pull up the rubber cap firmly in the direction indicated by the arrow (b).
- ③ When one side of the rubber cap is separated from the anode button, the anode-cap can be removed by turning up the rubber cap and pulling up it in the direction of the arrow (c).

• **HOW TO HANDLE AN ANODE-CAP**

- ① Don't hurt the surface of anode-caps with sharp shaped material!
- ② Don't press the rubber hardly not to hurt inside of anode-caps!
A material fitting called as shatter-hook terminal is built in the rubber.
- ③ Don't turn the foot of rubber over hardly!
The shatter-hook terminal will stick out or hurt the rubber.

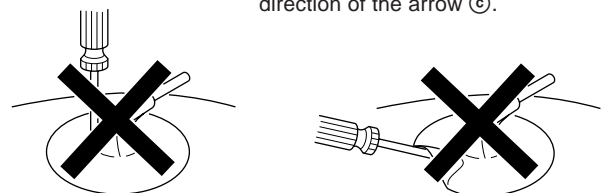

SECTION 3

SAFETY RELATED ADJUSTMENT

When replacing or repairing the shown below table, the following operational checks must be performed as a safety precaution against X-rays emissions from the unit.

	Part Replaced (▣)
HV Regulator Circuit Check	D Board IC901, T902 • Mounted D board
HV Protector Circuit Check	D Board Q590, Q591, D916, D935, C924, R597, R598, R940, R980, T902 • Mounted D board G Board PH680, Q680, Q683, D680, R680, R686, R687, R688, R689 • Mounted G board
Beam Current Protector Circuit Check	D Board IC901, D904, D907, D908, R011, R908, R909, R921, R925, R926, R929, R930, T902 • Mounted D board

Check Condition

Input voltage : 100~120 VAC

Input signal : White Cross Hatch at 96 kHz

Beam control : BRT and CONT → Minimum

B+ voltage : 177~183 VDC

a) HV Regulator Circuit Check

- 1) Confirm that the voltage of the pin ② of CN901 on D board is within the voltage range shown below.
Standard: 9.00 ± 0.068 VDC

b) HV Protector Circuit Check

- 1) Confirm that the HV protector circuit works and TV Raster disappears when apply the voltage as shown below between pin ③ of CN901 on D board and GND using an external DC power supply.
Check Condition: Less than 31.30 VDC

c) Beam Current Protector Circuit Check-1

- 1) Measure HV voltage and record that value.
- 2) Shorted between pin ① and pin ④ of CN901 on D board.
- 3) Connect to the Constant Current Jig (A) between pin ① of CN901 on D board and GND, confirm that the Beam Current Protector Circuit works and HV go down more than 1.50 kV from the value of (1).
Check Condition: 1.50 mA

d) Beam Current Protector Circuit Check-2

- 1) Connect to the Constant Current Jig (B) between pin ① of CN901 on D board and GND, confirm that the Beam Current Protector Circuit works and TV Raster disappears.
Check Condition: 1.57 mA

e) Voltage of 3rd winding of FBT

- 1) Confirm that the voltage of pin ③ of CN901 on D board is within the voltage range shown below.
Standard: more than 23.30 VDC

SECTION 4

ADJUSTMENTS

GDM-4011P

• Landing Rough Adjustment

1. Enter the full white signal. (or the full black dots signal).
2. Adjust the contrast to the maximum.
3. Make the screen monogreen.
4. Adjust the brightness is easy to see with the G2 resistor.
5. Reverse the DY, and adjust coarsely the purity magnet so that a green raster positions in the center of screen.
6. Moving the DY forward, adjust so that an entire screen becomes monogreen.
7. Adjust the tilt of DY, and fix lightly with a clamp.

• Landing Fine Adjustment

1. Put the set inside the Helmholtz coil.
2. Input the single green signal and set the CONT control to MAX.

Note: Set to $\Sigma 1k=200 \mu A$ with the signal green signal, and after aging for about 30 minutes, adjust so that it is exactly this value.

3. Demagnetize the metal part of the chassis with the hand degausser and coil degausser, and the CRT surface with the hand degausser.

Input AC 230V to AC IN, turn on and off the power to perform auto degaussing. (Perform auto degaussing by setting "MONCONREG2"=152. Return to the original value after use.)

Demagnetize the CRT surface with the hand degausser again.

Note:

- (1) Adjust in a non-magnetic field. $BV=45uT$.
- (2) If adjusting in a magnetic field, add the shift from the non-magnetic field in your estimation.
4. Attach the wobbling coil to the designated part of the CRT neck.
5. Attach the sensor of the landing adjustment unit on the CRT surface.
6. Adjust the DY position and purity, and the DY tilt, and landing of the center and 4 corners with the landing checker.

Adjust the green of corners 1 to 4, and center 6 to $\pm 5 \mu m$, and red and blue to within $\pm 7 \mu m$ of green, and the difference between red and blue to within $\pm 10 \mu m$.

Adjust the green of 5 and 7 to within $\pm 10 \mu m$, and red and blue to within $\pm 7 \mu m$ of green, and the difference between red and blue to within $\pm 10 \mu m$.

(Set each corner to 1st frame of the crosshatch.)

7. For the up/down and left/right swing, swing the DY and insert a wedge so that the up and down pins are equal at the top and bottom and the horizontal trapezoid is equal at the left and right. Insert the wedge firmly so that the DY does not shake.
8. Check the landing of each corner, and if they do not satisfy the specification, paste a Disk-Mg onto the funnel and adjust.

Note:

- (1) Do not paste more than 2 magnets to one corner.
- (2) Paste within 80 to 100 mm from the DY on the diagonal line of the magnet.
- (3) If using the magnet, be sure to demagnetize with the hand degausser and check.
9. Remove the sensor and wobbling coil.
10. Switch the signal to R.G.B., and check that each color is pure.
11. Check that the DY is not tilting, and fix the purity Mg with a white pen.

<Specification>

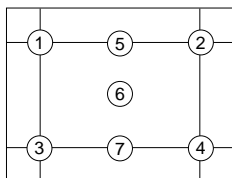

GDM-4011P

Connect the communication cable of the computer to the connector located on the D board on the monitor. Run the service software and then follow the instruction.

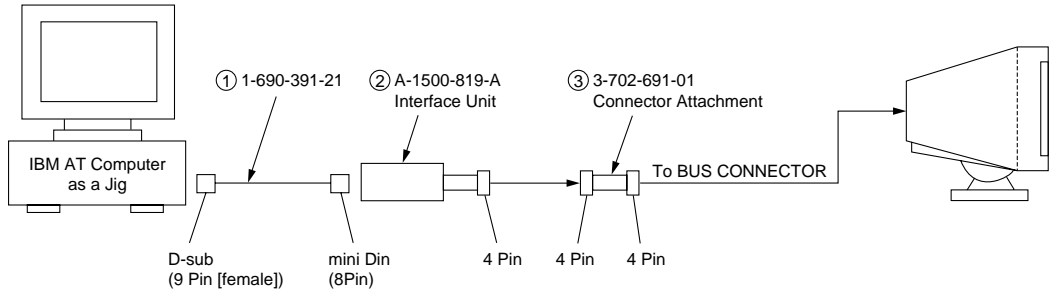

*The parts above (1) ~ (3) are necessary for DAS adjustment.

• Convergence Rough Adjustment

- (1) Receive an image of the white crosshatch signals (white lines on black).
- (2) Place the protrusions of the 6-fold poles magnet attached to the CRT neck upon each other.
- (3) Make rough adjustment of the H direction convergence by using H. STAT VR (left side of the video block).
- (4) Make a rough adjustment of the V direction convergence by using "V. STAT".

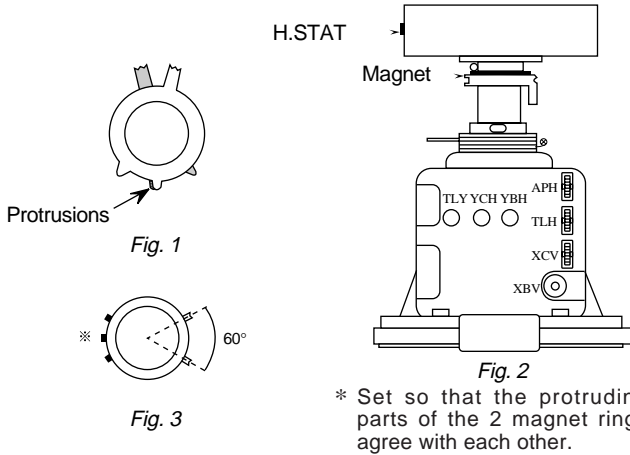

• Convergence Specification

MODE	Zone	N. Hemisphere	S. Hemisphere
fH ≥ 60 kHz	A zone	0.24 mm	0.28 mm
	B zone	0.24 mm	0.28 mm
	C zone	0.32 mm	0.36 mm
fH < 60 kHz	A zone	0.24 mm	0.28 mm
	B zone	0.32 mm	0.36 mm
	C zone	0.36 mm	0.40 mm

• White Balance Adjustment Specification

- (1) 9300K
 $x = 0.283 \pm 0.005$
 $y = 0.298 \pm 0.005$
 (All White)
- (2) 6500K
 $x = 0.313 \pm 0.005$
 $y = 0.329 \pm 0.005$
 (All White)
- (3) 5000K
 $x = 0.346 \pm 0.005$
 $y = 0.359 \pm 0.005$
 (All White)

• Vertical and Horizontal Position and Size Specification

MODE	1-5, 10	6, 7, 9	8
A	350 mm	373 mm	373 mm
B	280 mm	280 mm	201 mm

$a \leq 2.8 \text{ mm}$
 $b \leq 2.8 \text{ mm}$

• Focus adjustment

Adjust the focus volume 1 and 2 for the optimum focus.

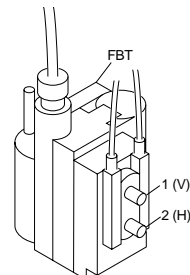

SECTION 5 DIAGRAMS

5-1. BLOCK DIAGRAMS

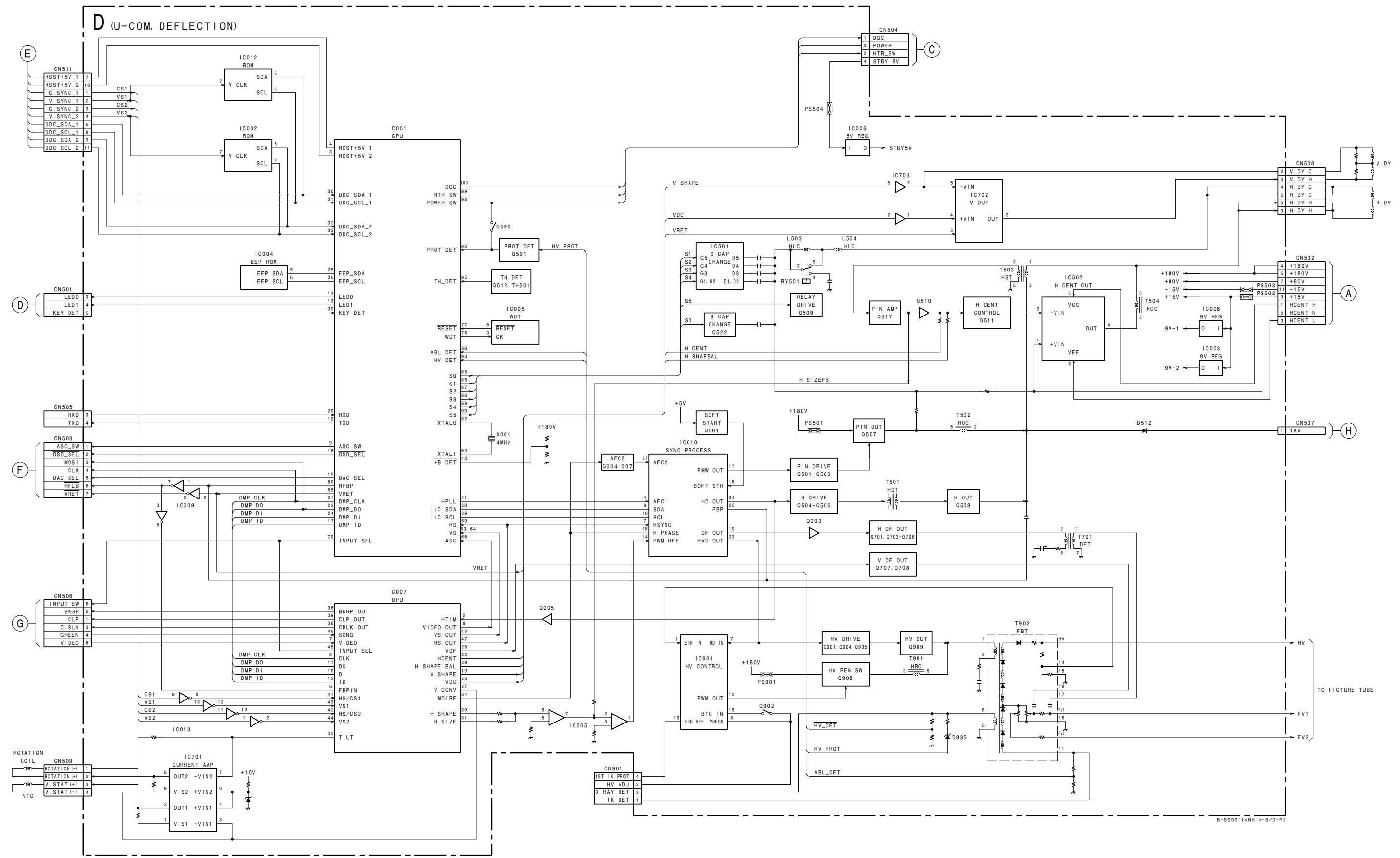
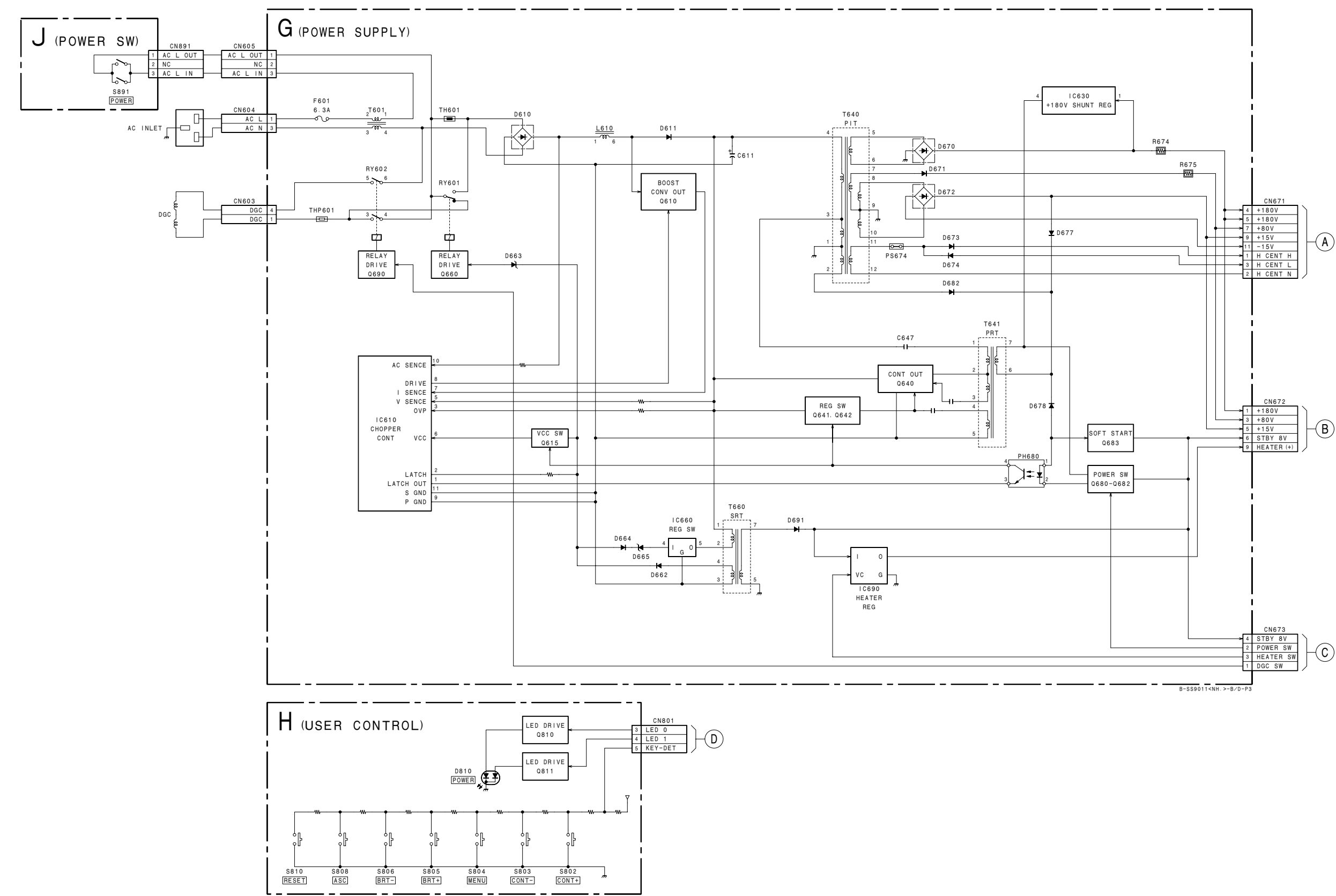

5-2. FRAME SCHEMATIC DIAGRAM

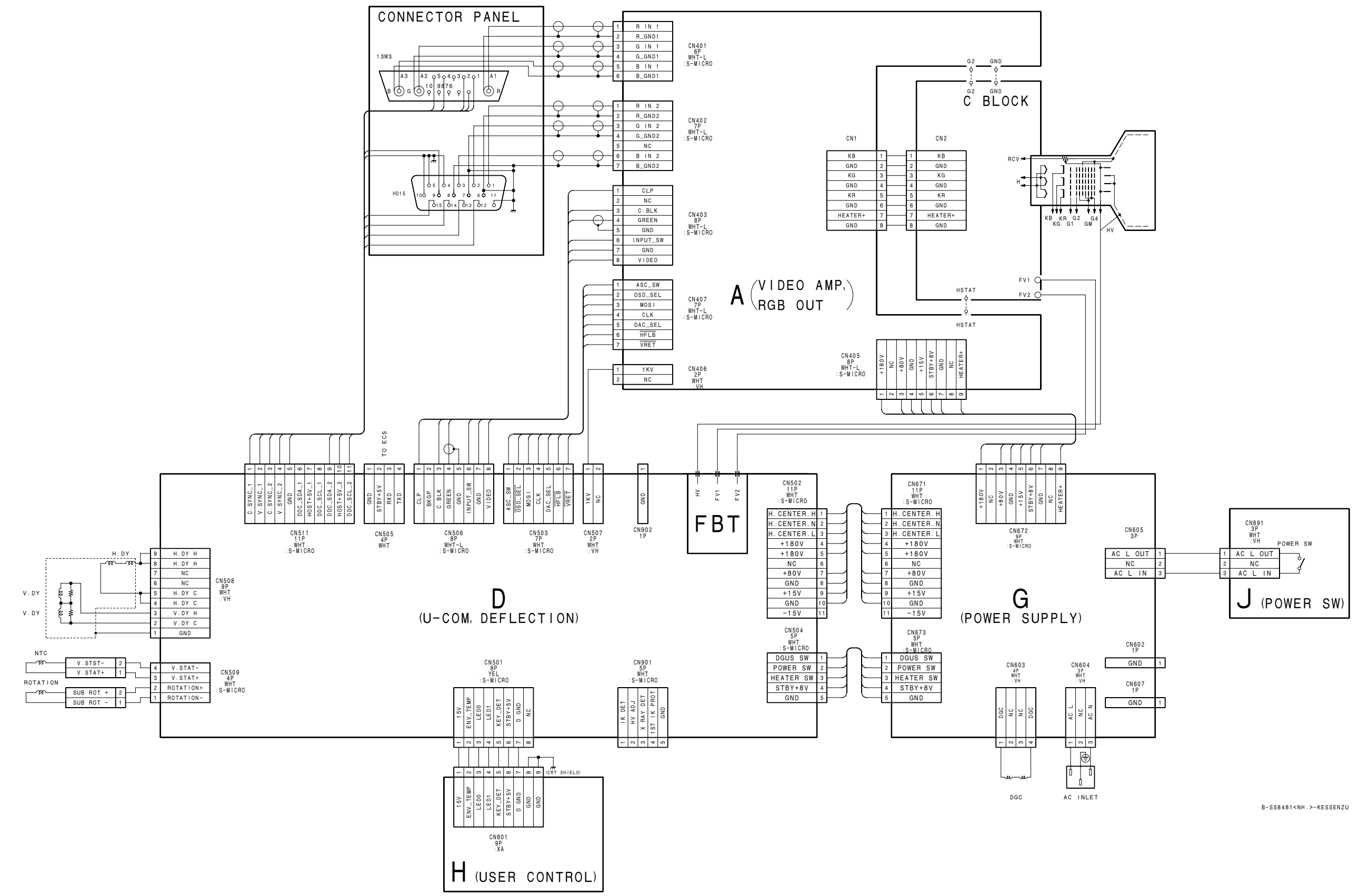
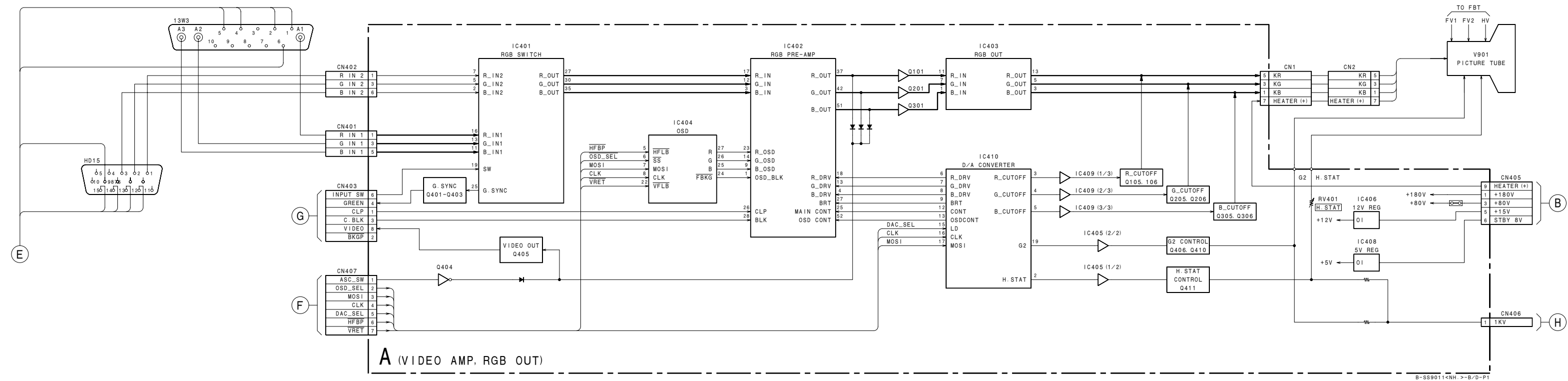

• G BOARD VOLTAGE LIST

Ref.	Pin No.	Voltage [V]	Ref.	Pin No.	Voltage [V]	
IC610	1	0	Q640	B1	-1.8	
	2	0.6		C1	187.3	
	3	*		B2	185.2	
	5	2.3		C2	380.0	
	6	14.8		E2	187.3	
	7	0.2				
IC630	1	179.7	Q641	B	1.1	
	3	2.5		C	-1.8	
	4	12.5		E	0.2	
IC660	4	5.8	Q660	B	0.8	
	5	389.0		C	0.2	
IC690	IN	7.0	Q680	B	0.7	
	OUT	6.3		C	0	
	VC	4.8				
PH680	1	1.2	Q681	B	0.2	
	2	0		C	12.4	
	3	0				
	4	-0.4				
Q610	G	9.6	Q683	B	6.5	
	D	92.0		C	7.0	
	S	0.2		E	7.0	
Q615	B	14.1	Q690	B	0	
	C	14.8		C	15.3	
	E	14.9				

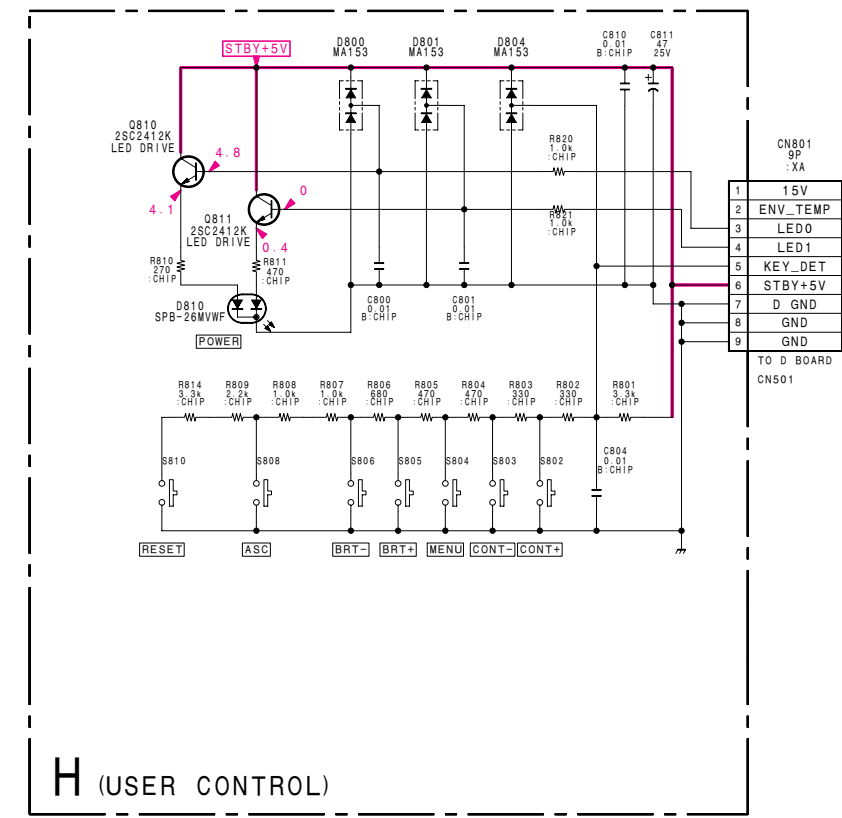
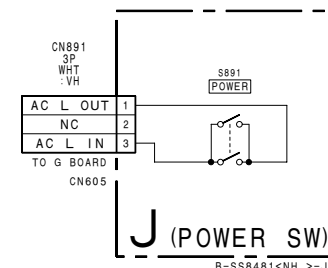

— H BOARD (Conductor side) —

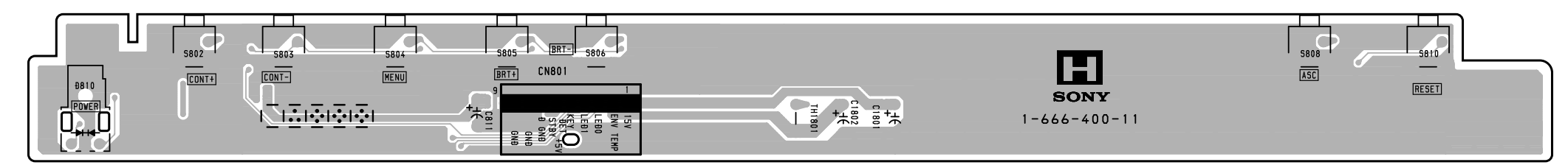

— H BOARD (Component side) —

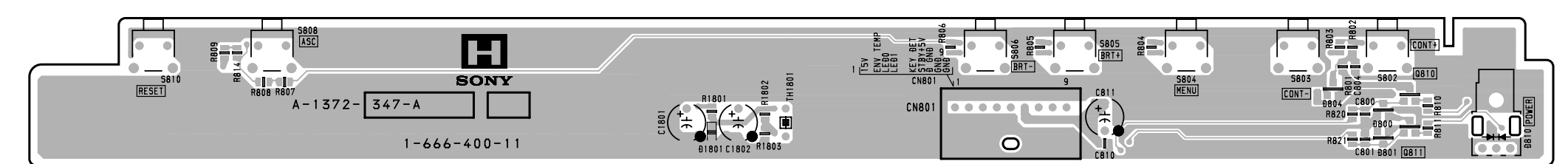

H BOARD
Terminal name of semiconductors
in silk screen printed circuit (※)

Ref.	※
Q810, Q811	②
D800, D801, D804	⑦

※: Refer to Terminal name of semiconductors in silk screen printed circuit (see page 5-9)

— J BOARD —

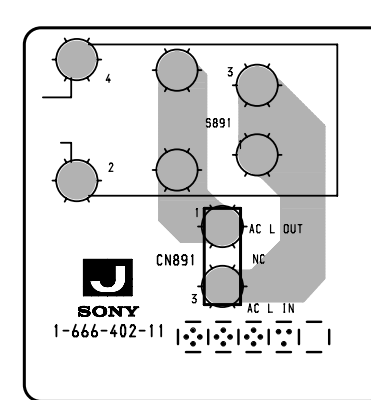

— G BOARD —

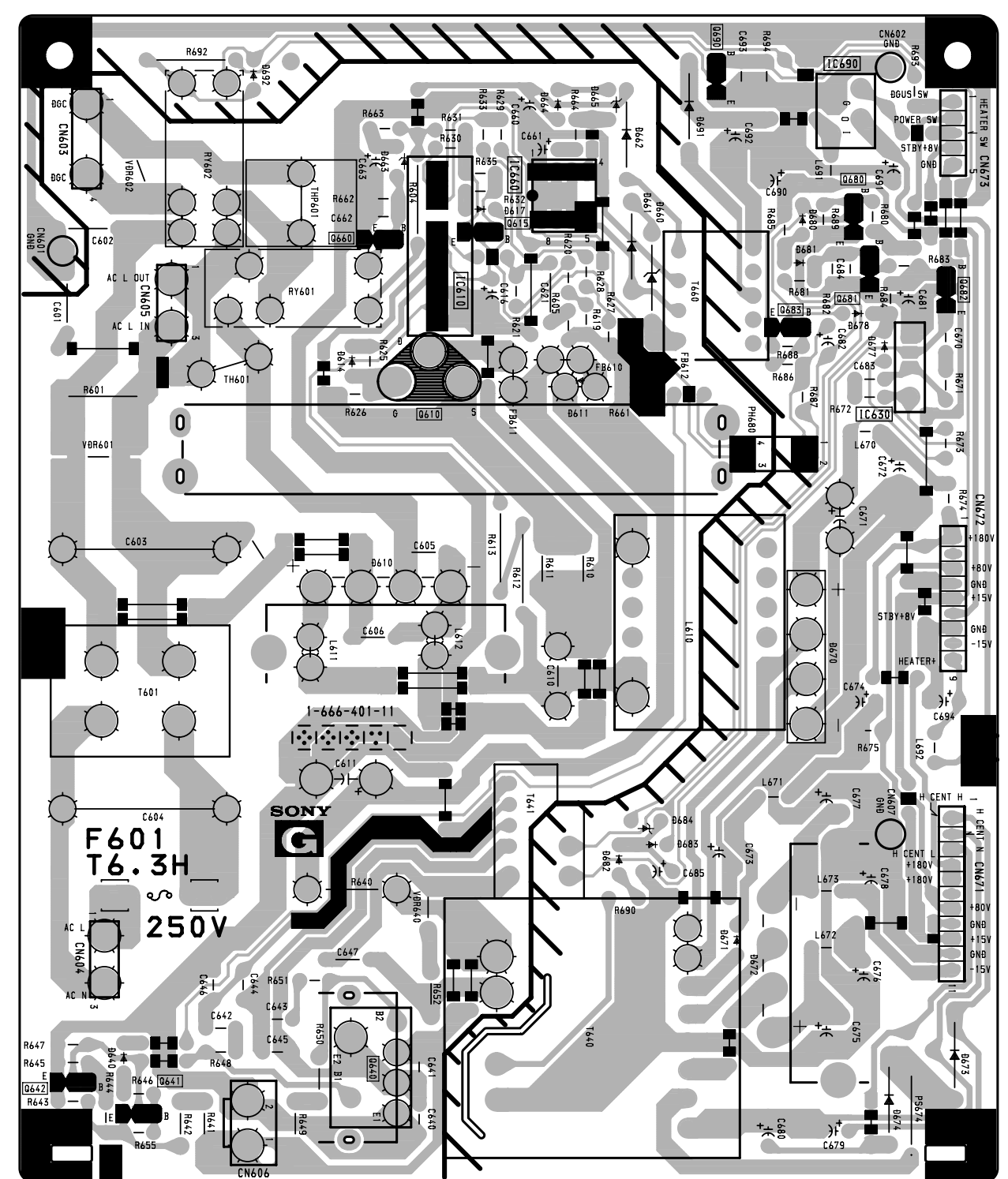

5-3. CIRCUIT BOARDS LOCATION

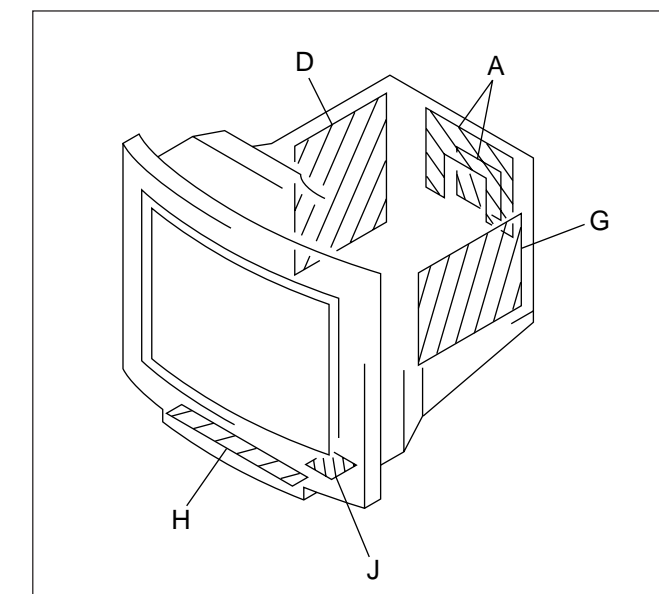

Note: The components identified by shading and mark Δ are critical for safety. Replace only with part number specified.

Note: Les composants identifiés par un trame et une marque Δ sont critiques pour la sécurité. Ne les remplacer que par une pièce portant le numéro spécifié.

- All voltages are in V.
- Readings are taken with a 10 M digital multimeter.
- Readings are taken with a color-bar signal input.
- Voltage variations may be noted due to normal production tolerances.
- * : Can not be measured.
- : Circled numbers are waveform references.
- : B + bus.
- - - : B - bus.

Terminal name of semiconductors in silk screen printed circuit (※)

Device	Printed symbol	Terminal name	Circuit
① Transistor		Collector Base Emitter	
② Transistor		Collector Base Emitter	
③ Diode		Cathode Anode	
④ Diode		Cathode Anode (NC)	
⑤ Diode		Cathode Anode (NC)	
⑥ Diode		Common Anode Cathode	
⑦ Diode		Common Anode Cathode	
⑧ Diode		Common Anode Anode	
⑨ Diode		Common Cathode Cathode	
⑩ Diode		Common Cathode Anode	
⑪ Diode		Common Cathode Cathode	
⑫ Diode		Anode Cathode Cathode	
⑬ Diode		Anode Anode Anode	
⑭ Transistor (FET)		Drain Gate	
⑮ Transistor (FET)		Drain Source Gate	
⑯ Transistor (FET)		Source Drain Gate	
⑰ Transistor		Emitter Collector Base	

(Chip semiconductors that are not actually used are included.)

5-4. SCHEMATIC DIAGRAMS AND PRINTED WIRING BOARDS

- All capacitors are in μF unless otherwise noted. (pF: μpF)
- Capacitors without voltage indication are all 50 V.
- Indication of resistance, which does not have one for rating electrical power, is as follows.

Pitch: 5 mm
Rating electrical power 1/4 W (CHIP: 1/10 W)

- All resistors are in ohms.
- : nonflammable resistor.
- : fusible resistor.
- : internal component.
- : panel designation, and adjustment for repair.
- All variable and adjustable resistors have characteristic curve B, unless otherwise noted.
- : earth-ground.
- : earth-chassis.
- When replacing components identified by Δ , make the necessary adjustments indicated. (See page 3-1)
- When replacing the part in below table, be sure to perform the related adjustment.

	Part replaced (Δ)
HV Regulator Circuit Check	D Board IC901, T902 • Mounted D board
HV Protector Circuit Check	D Board Q590, Q591, D916, D935, C924, R597, R599, R940, R980, T902 G Board • Mounted D board • D908, Q680, Q683, D680, R680, R686, R687, R688, R689 • Mounted G board
Beam Current Protector Circuit Check	D Board IC901, D904, D907, D908, R011, R908, R909, R921, R925, R926, R929, R930, T902 • Mounted D board

(2) Schematic Diagram of D Board

• D BOARD WAVEFORMS

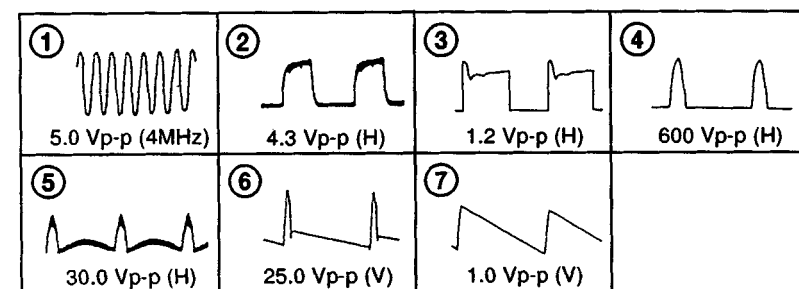

• D BOARD IC701 LA6510

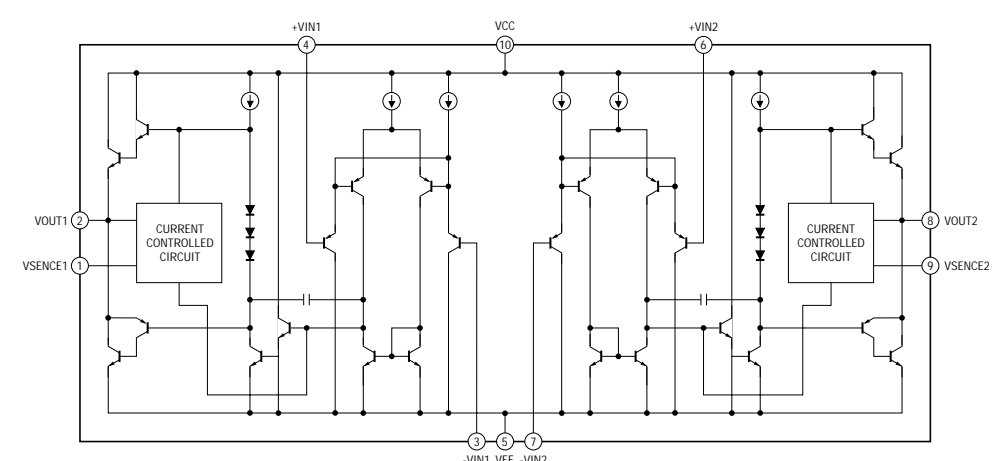

• D BOARD VOLTAGE LIST

Ref.	Pin No.	Voltage [V]	Ref.	Pin No.	Voltage [V]
IC002	5	1.1	7	0.9	
	6	4.2	8	9.3	
	7	0	10	0	
			11	0	
IC004	5	4.8	12	11.2	
	6	4.8	15	0	
IC005	1	0.4	16	8.4	
	3	0	19	9.2	
	7	1.5			
	8	4.8			
IC009	1	-0.1	Q003	B	5.1
	2	4.5		C	0
	3	4.7		E	5.7
	4	0.3			
	5	0.3			
	6	0.3			
	7	4.5			
IC010	1	4.0	Q501	B	11.2
	3	3.0		C	13.8
	4	2.8		E	10.8
	5	2.3	Q502	B	0.2
	6	2.6		C	11.2
	7	0.6			
	9	4.8	Q503	B	11.2
	10	4.8		C	12.0
	12	5.4		E	2.5
	14	4.5			
	15	4.5			
	16	5.4	Q504	B	2.5
	17	1.0		C	12.0
	18	0		E	2.4
	19	5.1	Q506	B	-14.0
	20	3.7		C	-0.2
	23	0.8		E	-14.0
	24	2.5	Q507	G	197.4
	25	-0.1		D	41.8
	26	4.0			
	27	4.0	Q508	B	-1.4
	28	4.4		C	41.0
IC012	5	0.6	Q509	B	0
	6	3.9		C	14.1
	7	4.1			
IC013	1	0	Q510	B	4.5
	2	4.9		E	3.9
	8	0.6			
	9	3.6	Q511	B	3.2
	10	4.9		E	33.5
	11	0			
	12	0			
	13	0	Q517	B	4.6
				E	5.1
IC501	2	0	Q522	G	D
	3	27.7			
	4	0	Q590	B	4.2
	5	27.7		C	0
	6	4.8		E	0
	7	0			
	8	4.7	Q591	B	0
	9	0		C	4.2
	10	4.7			
	11	0	Q701	B	5.7
IC502	1	41.4		C	36.0
	2	41.4		E	5.1
	3	33.7	Q703	B	37.9
	4	42.3		E	37.4
	5	48.3			
IC505	1	4.5	Q704	B	37.4
	2	0		E	37.0
	3	0	Q705	B	36.0
	6	0		E	36.6
	7	-10.0	Q706	B	36.6
				E	37.0
IC701	1	14.2	Q707	B	-0.6
	2	14.2		C	-5.0
	3	0		E	0
	4	3.6			
	6	3.0	Q708	B	0.6
	7	3.0		C	477.0
	8	-0.7			
	9	-0.7	Q901	B	0.1
				C	9.9
IC702	2	0.4	Q902	B	9.0
	3	13.5		C	0
	4	1.2		E	9.0
	5	1.2			
IC703	1	1.2	Q904	B	8.6
	2	1.6		E	8.4
	3	1.6			
	5	2.8	Q905	B	8.6
	6	2.8		E	8.4
	7	2.8			
			Q908	G	176.1
				D	67.8
IC901	1	9.3	Q909	G	7.9
	2	5.6		D	=
	4	5.0			
	6	1.1			

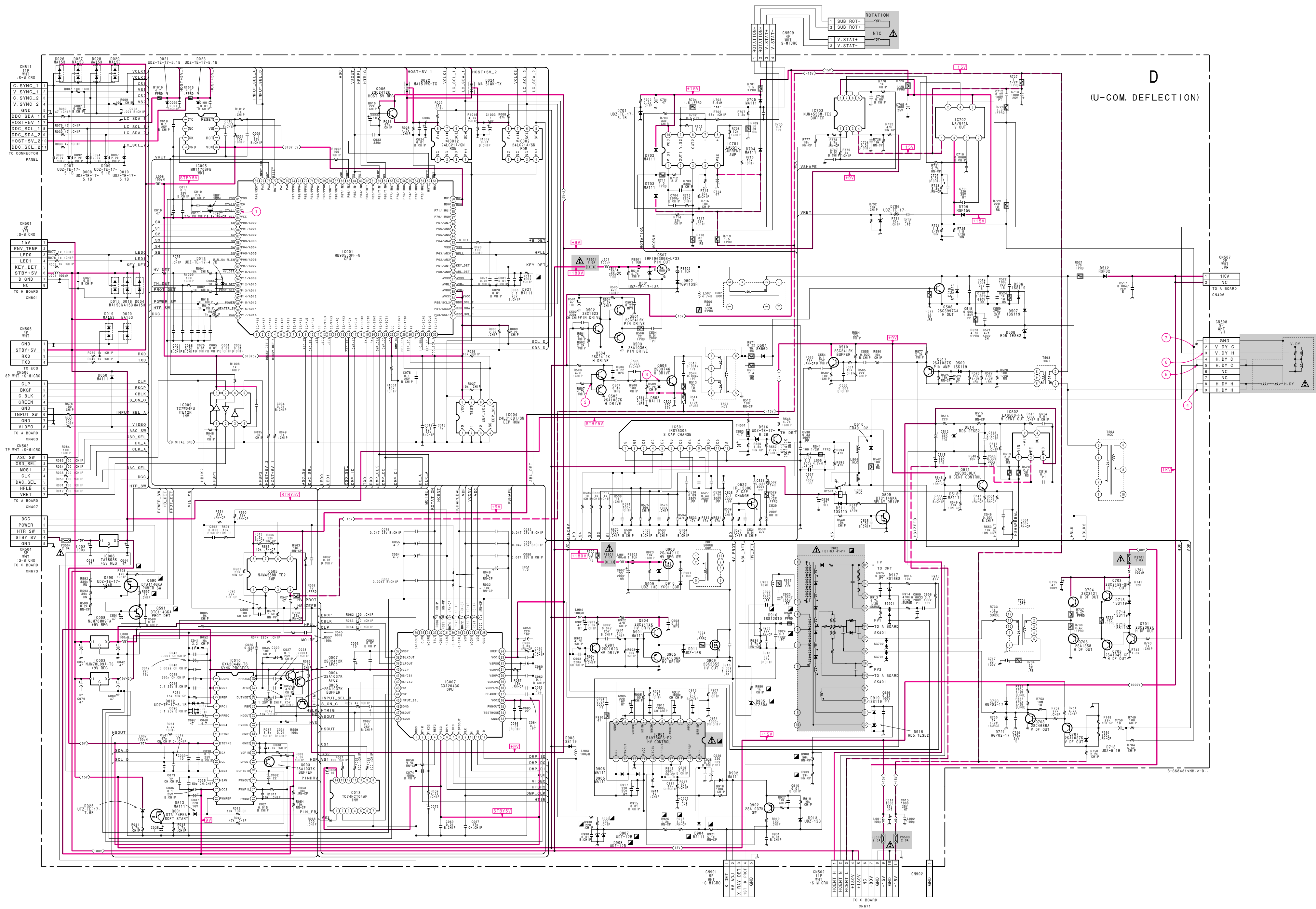

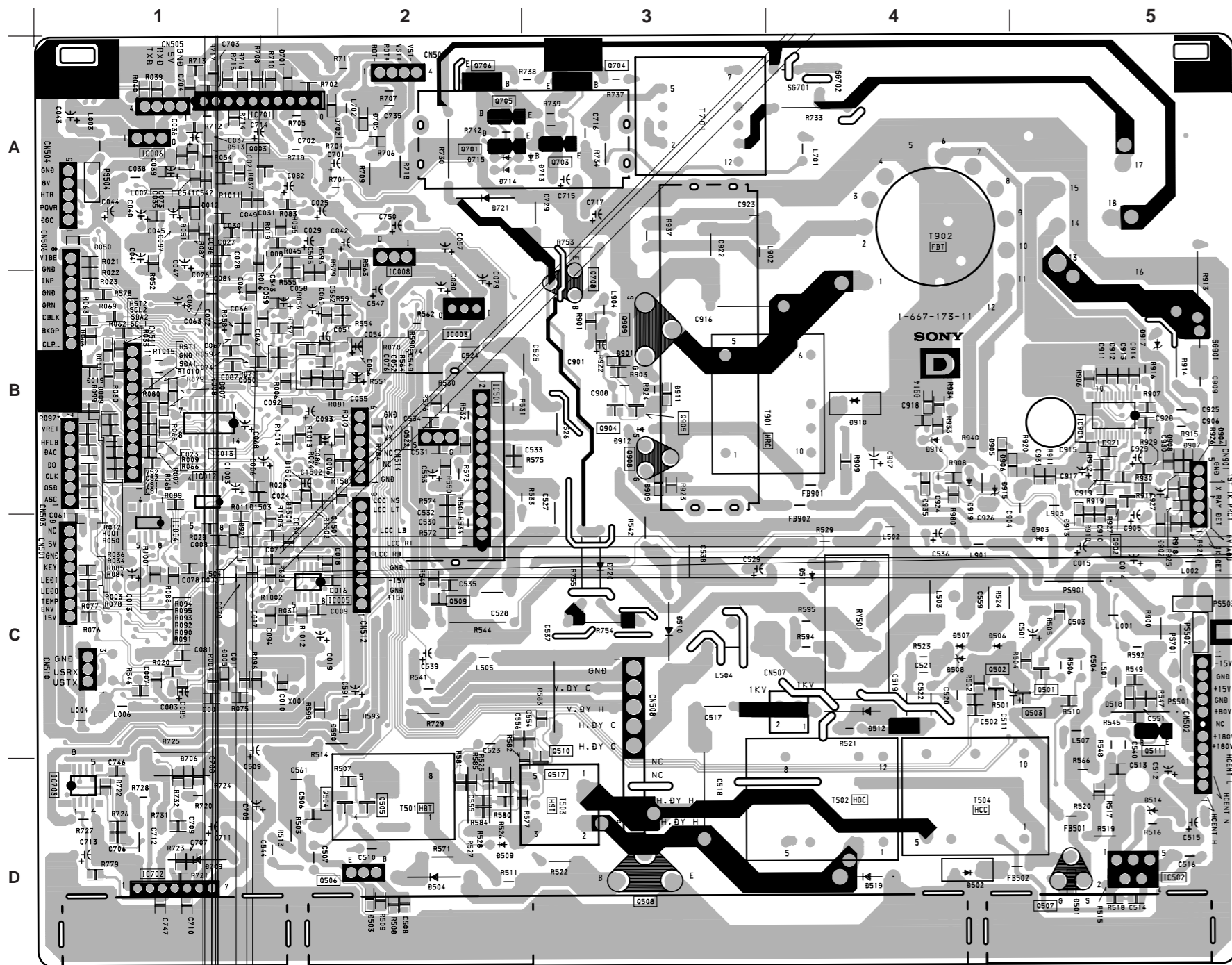

• D BOARD SEMICONDUCTOR LOCATION

IC	(Conductor Side)	(Component Side)	D010	B-1	③
IC001	C-5		D012	A-1	③
IC002	B-5		D013		③
IC003	B-4		D015		⑦
IC004	B-1		D016		⑦
IC005	C-2		D019	B-1	⑥
IC006	A-1	A-5	D020		⑦
IC007	B-5	B-5	D021	A-5	⑦
IC008	A-2	A-4	D022	B-5	⑧
IC009	C-4	C-4	D023	B-5	⑧
IC010	A-5	A-5	D024	B-5	⑧
IC012	B-1	B-4	D025	A-4	③
IC501	B-2	D-1	D026	B-5	⑦
IC502	D-5	B-4	D027	B-5	⑦
IC505		B-4	D028	B-5	⑦
IC701	A-1	A-5	D029	B-5	⑦
IC702	D-1	D-5	D050	A-1	③
IC703	D-1	D-5	D501	D-5	③
IC901	B-5		D502	D-4	②
			D503	D-2	②
			D504	D-2	④
			D506	C-4	①
			D507	C-4	②
			D508	C-4	②
			D509	D-2	④
			D510	C-3	③
			D511	C-4	②
			D512	C-4	②
			D513	A-1	③
			D514	D-5	①
			D516	B-4	③
			D518	C-5	③
			D519	D-4	②
			D590	C-2	②
			D701	A-2	②
			D702	A-2	②
			D703		②
			D704	A-5	②
			D705	A-2	②
			D706	D-1	②
			D709	D-1	⑤
			D713	A-3	②
			D714	A-2	④
			D715	A-2	④
			D718	B-4	②
			D720	C-3	③
			D721	A-2	④
			D901	B-3	③
			D902	C-5	③
			D903	C-5	①
			D904	B-5	②
			D906	B-4	②
			D907	B-5	②
			D908	B-5	②
			D909	B-3	②
			D910	B-4	②
			D911	B-3	③
			D913	B-5	②
			D915	B-4	①
			D916	B-4	②
			D917	B-5	①
			D919	B-4	②
			D921	C-1	③
			D935	B-4	③

TRANSISTOR		(Conductor Side)	(Component Side)*
Q001			
Q004	A-1	A-4	②
Q005		A-4	②
Q006	B-2	A-4	②
Q007		A-4	②
Q501	C-5		①
Q502	C-4		①
Q503	C-5		①
Q504	D-2		①
Q505	D-2		①
Q506	D-2	D-4	①
Q507	D-5	D-1	①
Q508	D-3	D-3	①
Q509	C-2		①
Q510	C-3		①
Q511	C-5		①
Q512		C-1	②
Q517	D-2		①
Q522	B-2	B-4	①
Q590		C-4	②
Q591		C-4	②
Q701	A-2	A-4	②
Q703	A-3	A-3	②
Q704	A-3	A-3	②
Q705	A-2	A-4	②
Q706	A-2	A-4	②
Q707		B-3	②
Q708	A-3	A-3	②
Q901		B-3	②
Q902	B-5		①
Q904	B-3		①
Q905	B-3		①
Q908	B-3	B-3	①
Q909	B-3	B-3	①

DIODE		(Conductor Side)	(Component Side)*
D004			C-5 ⑦
D007	B-1		③
D008	B-1		③
D009	B-1		③

CRYSTAL		(Conductor Side)	(Component Side)
X001		C-2	C-4

*: Refer to Terminal name of semiconductors in silk screen printed circuit (see page 5-9)

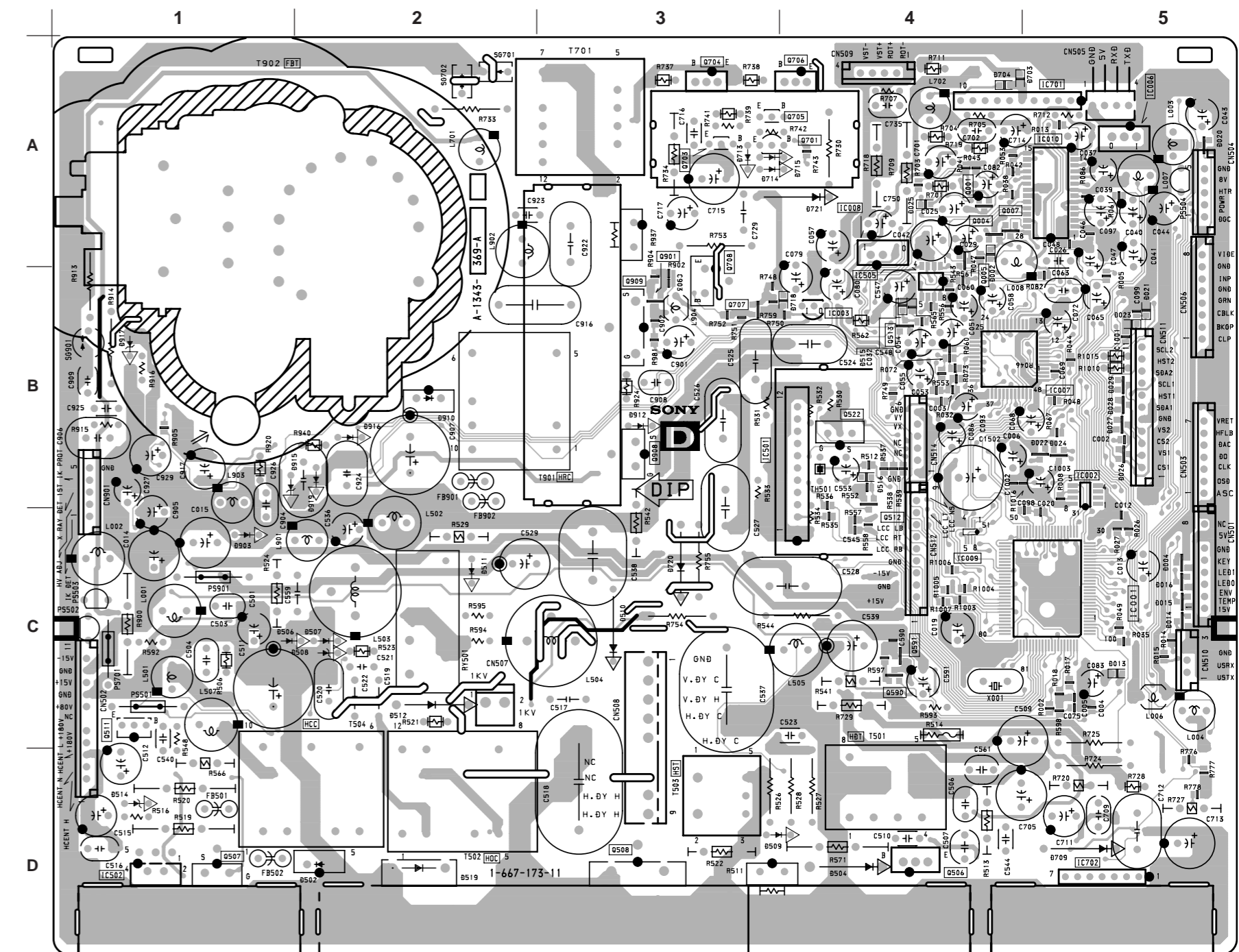

— A BOARD (Conductor Side) —

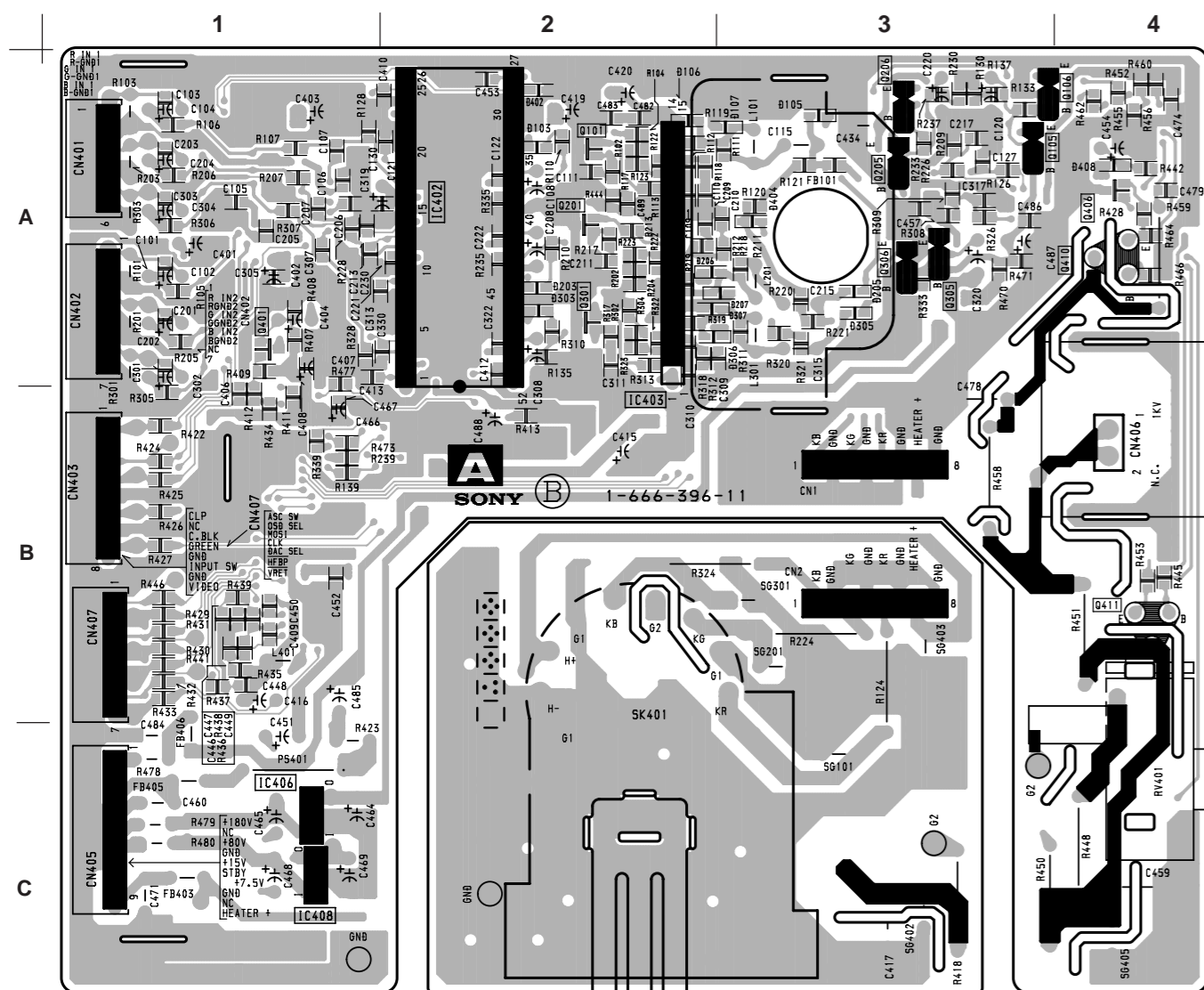

• A BOARD
SEMICONDUCTOR
LOCATION

IC	
(Conductor Side)	(Component Side)
IC401	A-3
IC402	A-2 A-3
IC403	A-2 A-2
IC404	B-3
IC405	A-1
IC406	C-1 C-3
IC408	C-1 C-3
IC409	A-1
IC410	B-3

TRANSISTOR	
(Conductor Side)	(Component Side) *
Q101	A-2 ①
Q105	A-3 A-1
Q106	A-3 A-1
Q201	A-2 ①
Q205	A-3 A-1
Q206	A-3 A-1
Q301	A-2 ①
Q305	A-3 A-1
Q306	A-3 A-1
Q401	A-1 ①
Q402	B-3 ②
Q403	B-3 ②
Q404	B-3 ②
Q405	B-2 ②
Q406	A-4 ②
Q410	A-4 A-1
Q411	B-4 B-1

DIODE	
(Conductor Side)	(Component Side) *
D101	A-3 ⑦
D102	A-3 ⑦
D103	A-2 ③
D104	A-2 ③
D105	A-3 ③
D106	A-2 ③
D107	A-2 ③
D201	A-3 ⑦
D202	A-3 ⑦
D203	A-2 ③
D204	A-2 ③
D205	A-3 ③
D206	A-2 ③
D207	A-2 ③
D301	B-3 ⑦
D302	A-3 ⑦
D303	A-2 ③
D304	A-2 ③
D305	A-3 ③
D306	A-2 ③
D307	A-2 ③
D401	B-3 ③
D402	A-2 ③
D404	A-3 ③
D408	A-4 ③

VARIABLE RESISTOR	
(Conductor Side)	(Component Side)
RV401	C-4 C-1

*: Refer to Terminal name of semiconductors in silk screen printed circuit (see page 5-9)

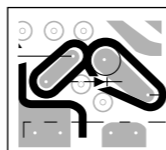

NOTE:
The circuit indicated as left contains high voltage of over 600 Vp-p. Care must be paid to prevent an electric shock in inspection or repairing.

— A BOARD (Component Side) —

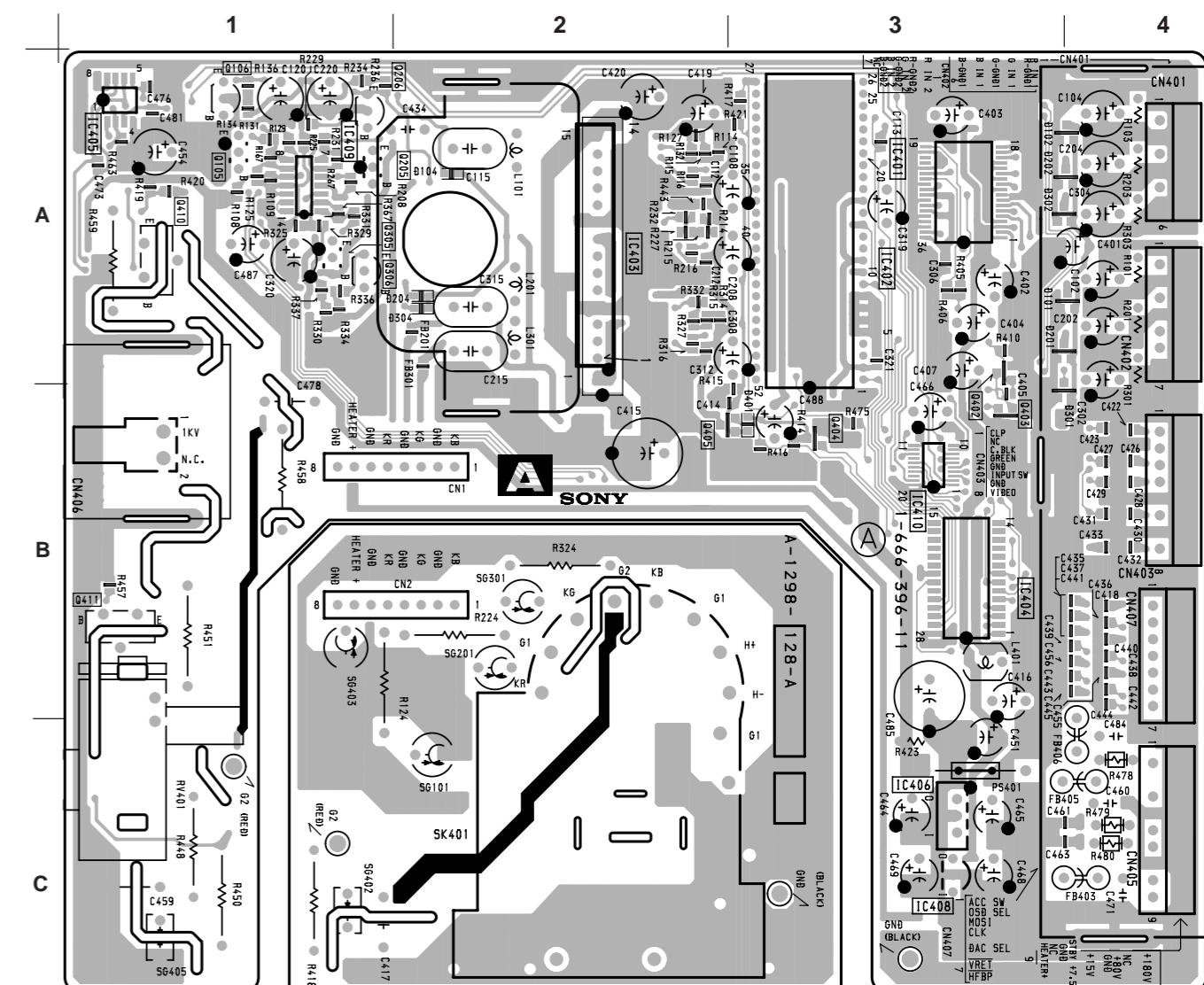

(3) Schematic Diagram of A Board

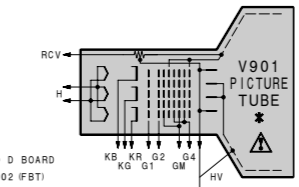
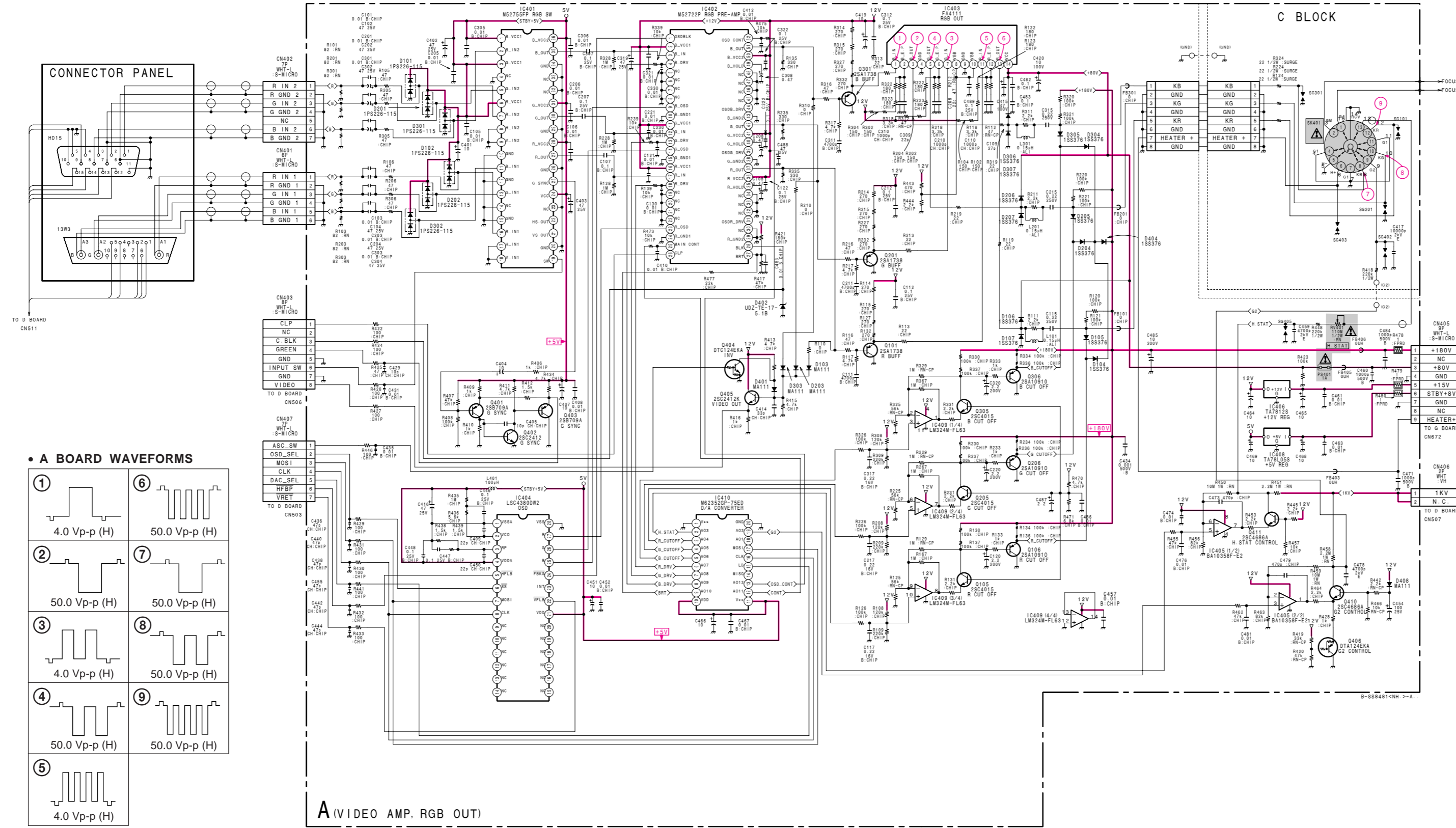

* V901 20SPG

• A BOARD VOLTAGE LIST

Ref.	Pin No.	Voltage [V]	Ref.	Pin No.	Voltage [V]	
IC402	1	1.1	Q106	B	101.7	
	3	2.8		E	6.4	
	4	3.7		Q201	B	2.7
	9	1.1			E	3.5
	12	2.8			Q205	B
	13	3.8		C		100.8
	14	1.1		E		6.5
	17	2.8		Q206	B	100.8
	18	3.9			C	101.3
	23	1.1		Q301	B	2.7
	25	3.3			E	3.4
	26	0.7		Q305	B	7.0
27	2.4	C	102.7			
28	1.2	Q306	B	102.7		
35	4.4		E	103.3		
37	2.7	IC403	1	+180V		
40	4.4		2	NC		
42	2.7		3	+80V		
49	4.4		4	GND		
51	2.7		5	+1.5V		
52	2.1		6	STBY+8V		
Q401	1		52.7	7	GND	
	2		2.8	8	NC	
	3		52.7	9	HEATER+	
Q406	5		52.7	10	9.8	
	6		2.9	11	9.8	
	7		3.5	12	2.9	
Q410	8	9.8	13	3.5		
	10	9.8	B	75.3		
	11	3.5	C	75.3		
Q105	12	2.9	SK401	KR	244.5	
	13	3.5	B	75.3		
			C	6.2		

• A BOARD WAVEFORMS

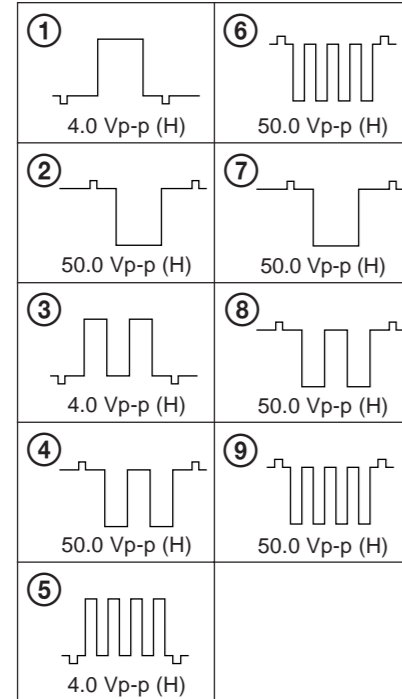

• A BOARD IC402 M52722P

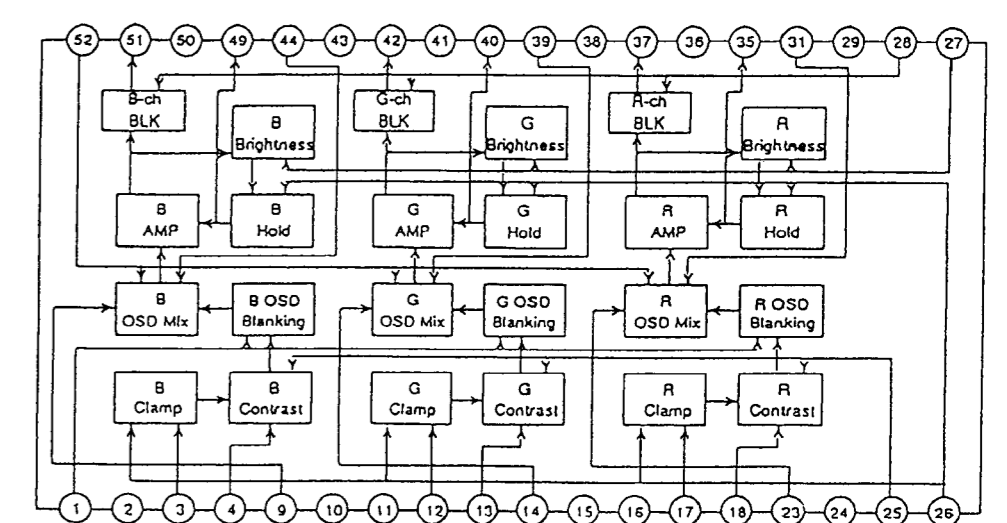

Schematic diagram
← A board

5-5. SEMICONDUCTORS

BA10358F-E2
 NJM4558M
 TC7W04FU
 μPC4558G2
 24LC16BT/SN
 24LC21A/SN

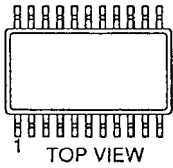

BA9756FS-E2
 M62352GP-75E
 M62352GP-75ED

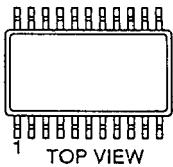

CXA2043Q

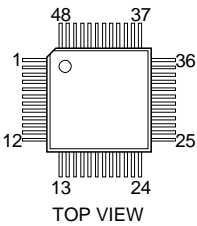

CXA2044M
 LSC4380DW2

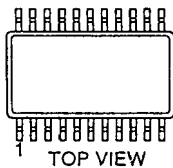

DM-57N

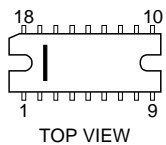

FA4111

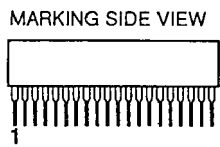

IRSY5305

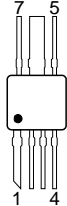

LA6500-FA

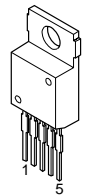

LA6510

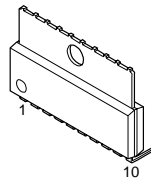

LA7841L

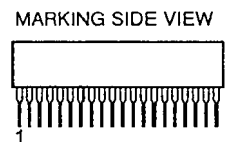

LM324M
 TC74HCT04AF

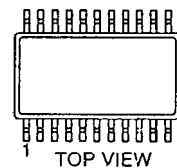

MB90553PF-G-106

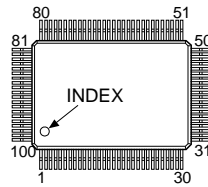

MC33262
 MM1170BFB

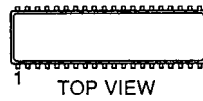

M52348FP

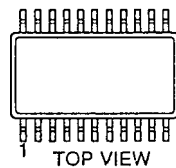

M52722P



NJM78L09A
 TA78L09S

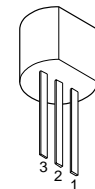

NJM78M09FA
 TA7805S
 TA7812S

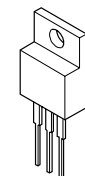

TME757

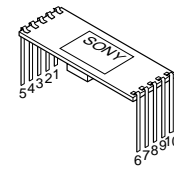

DTA114GKAT146
 DTA124EKA-T146
 DTC114GKA
 DTC114GKAT146
 DTC124EK
 DTC124EKA-T146
 2SA1036K-Q
 2SA1036K-T-146-Q
 2SA1037K-T-146-QR
 2SA1162G
 2SA1462-Y33
 2SA1738-TX
 2SB709A-QRS-TX
 2SC1623-L5L6
 2SC2412K-T-146-QR

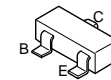

MX0541AB-F
 MX0541B-F

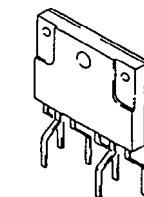

IRFI9630GS
 2SC3746
 2SC4686A (LBSONY)
 2SJ449
 2SJ449 (1)

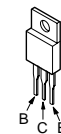

IRLI530G

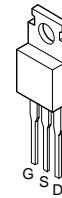

2SA1049-GR
 2SC2458-YGR
 2SC2459-GR

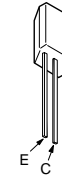

2SA1091-O
 2SC2362K-G



2SA1175-HFE
 2SA1309A-QRSTA
 2SC2784
 2SC2785-HFE
 2SC3311A-QRSTA

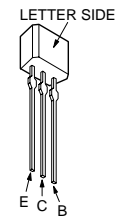

2SA1358-Y
 2SC3421-Y



2SC2362KG-AA

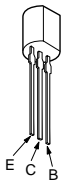

2SC3209LK

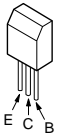

2SC3997CA

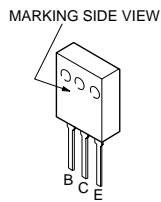

2SC4015TV2

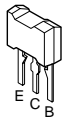

2SJ307-CB14

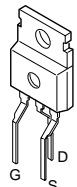

2SK2195F04

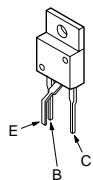

AG01A-V1
ERA91-02
S2LA20F

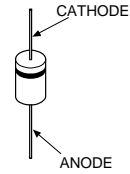

DTZ-TT11-16B
DTZ-TT11-30A
DTZ13B
DTZ24B
DTZ4.7C
DTZ5.1B
MA111
RD12SB2
UDZ-TE-17-12B
UDZ-TE-17-13B
UDZ-TE-17-16B
UDZ-TE-17-24B
UDZ-TE-17-4.7B
UDZ-TE-17-5.1B
UDZ-TE-17-6.2B
UDZ-TE-17-7.5B

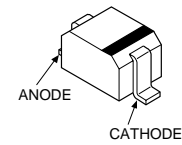

D1NL20-TR
GMA01
RD12ES-B2
RD13ES-B1
RD16ES-B2
RD16ES-B3
RD18ES-B2
RD5.1ES-B2
RD6.2ES-B2
1SS119-25TD
1SS119-25
1SS120TD

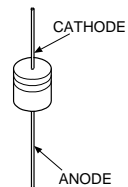

D2L20U
EGP20G
RGP02-17EL-6433
RGP02-17PKG23
RGP02-20EG23
RGP15GPKG23
UF4005PKG23

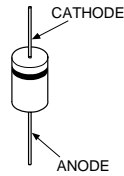

D2S4MF
D2S4MTA1

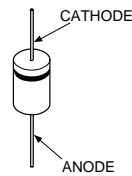

D4SBS4
D4SBS4-F
D4SBL40
D4SB60L

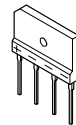

D5L60



FMQ-G5FMS
5TUZ52

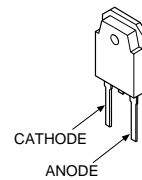

MA151WK
1SS184

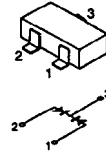

MA153
1SS226

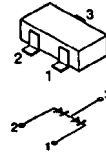

PC123F2
PC123FY2

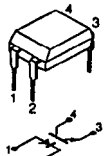

P6KE170AG23

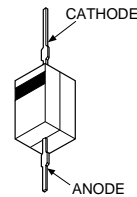

RD6.2M-B1

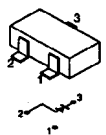

RM11A
RM11C

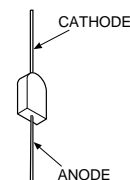

SB560

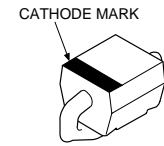

YG911S3R

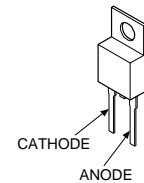

1PS226-115

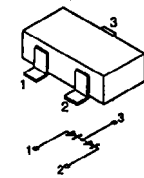

1SS376TE-17

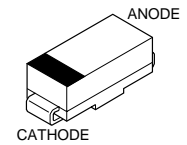

SPB-26MVWF

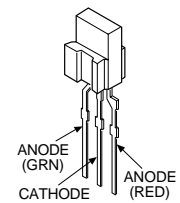

SECTION 6 EXPLODED VIEWS

- Items with no part number and no description are not stocked because they are seldom required for routine service.
- The construction parts of an assembled part are indicated with a collation number in the remark column.

- Items marked " * " are not stocked since they are seldom required for routine service. Some delay should be anticipated when ordering these items.

The components identified by shading and mark Δ are critical for safety. Replace only with part number specified.

Les composants identifiés par un tramé et une marque Δ sont critiques pour la sécurité. Ne les remplacer que par une pièce portant le numéro spécifié.

6-1. CHASSIS

- \blacktriangle 7-685-647-79 +BVTP 3X10 \circ 7-685-872-09 +BVTT 3X8
- \blacksquare 7-685-663-71 +BVTP 4X16 \triangle 7-685-881-09 +BVTT 4X8

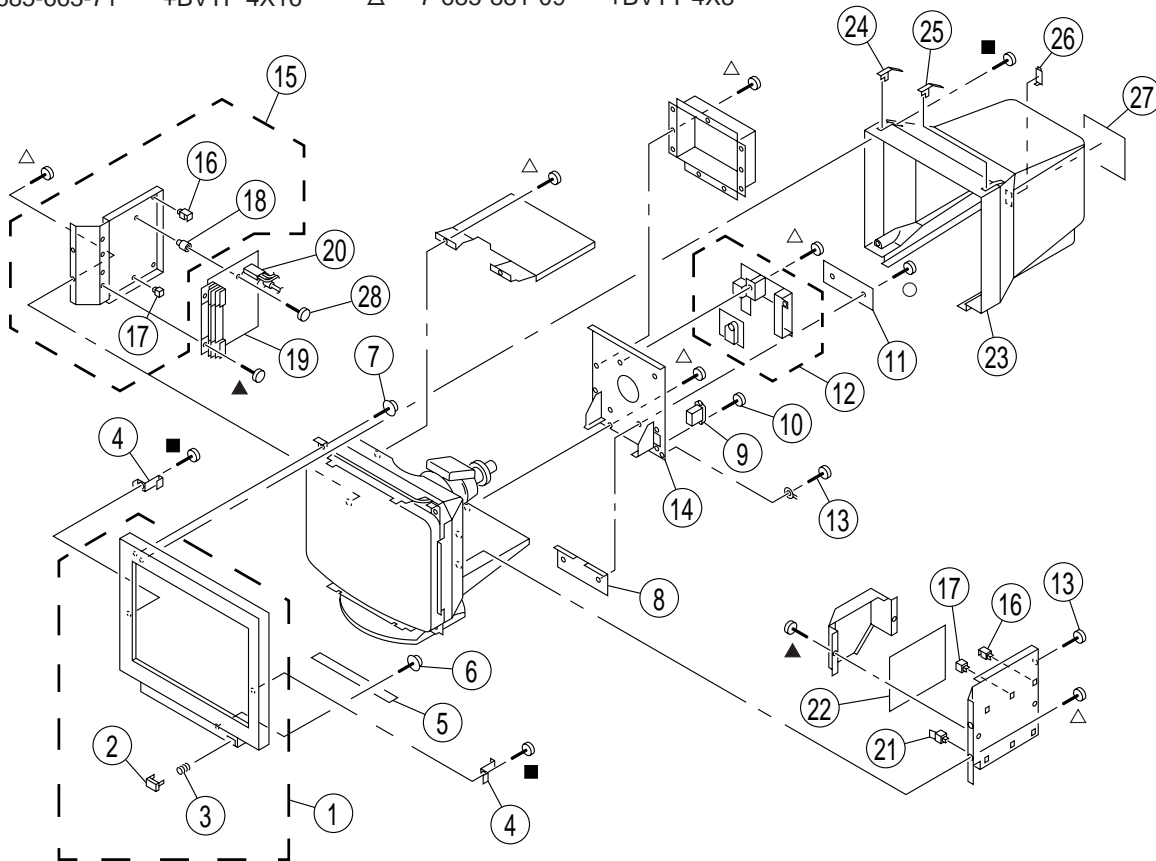

REF.NO.	PART NO.	DESCRIPTION	REMARK	REF.NO.	PART NO.	DESCRIPTION	REMARK
1	* X-4034-926-1	BEZEL ASSY [NH for Japan-made set]	2,3	17	* 4-382-848-01	HOLDER, PRINTED CIRCUIT BOARD	
1	* X-4034-968-1	BEZEL ASSY [NH for USA-made set]	2,3	18	* 4-060-359-01	HOLDER, PRINTED CIRCUIT BOARD	
2	* 4-060-356-11	BUTTON, POWER [NH for Japan-made set]		19	* 8-933-251-00	DEFLECTION MCB ASSY (D BOARD)	
2	* 4-061-156-01	BUTTON, POWER [NH for USA-made set]		20	Δ X-4034-920-1	TRANSFORMER ASSY, FLAYBACK	
3	3-653-339-01	SPRING, COMPRESSION				(NX-4141//J1D4)	
			[NH for Japan-made set]	21	* 3-703-141-00	HOLDER, PRINTED CIRCUIT BOARD	
3	3-653-339-21	SPRING, COMPRESSION [NH for USA-made set]		22	* 8-933-252-00	SWITCHING REGULATOR UNIT (G BOARD)	
4	* 4-051-566-01	HOOK (20) [NH for Japan-made set]		23	* 4-060-380-11	CABINET [NH for Japan-made set]	
4	* 4-051-566-11	HOOK (20) [NH for USA-made set]		23	* 4-061-162-01	CABINET [NH for USA-made set]	
5	* 8-933-254-00	CONTROL BLOCK ASSY (H BOARD)		24	* 4-060-376-11	COVER (L), SCREW	
6	4-029-432-01	SCREW (3X12), (+) BVWHTP				[NH for Japan-made set]	
7	4-365-808-01	SCREW (5), TAPPING		24	* 4-061-159-01	COVER (L), SCREW	
8	1-694-351-13	TERMINAL BOARD ASSY, I/O				[NH for USA-made set]	
9	Δ 1-251-382-12	INLET, AC 3P(WITH NOISE FILTE)		25	* 4-060-375-11	COVER (R), SCREW	
10	4-052-345-01	SCREW, (3X8) (+K), TAPPING				[NH for Japan-made set]	
11	* 4-060-954-01	SHEET, CONNECTOR		25	* 4-061-158-01	COVER (R), SCREW [NH for USA-made set]	
12	* 8-933-250-00	VIDEO AMP MCB ASSY (A BOARD)		26	* 4-060-358-11	COVER, ECS [NH for Japan-made set]	
13	4-389-025-01	SCREW (M4) (EXT TOOTH WASHER)		26	* 4-061-155-01	COVER, ECS [NH for USA-made set]	
14	* X-4034-835-1	SHIELD ASSY, REAR		27	* 4-060-955-01	LABEL, INFORMATION [NH for Japan-made set]	
15	* X-4034-837-2	COVER (D) ASSY, SIDE	16-18	27	* 4-060-995-21	LABEL, INFORMATION [SH]	
16	* 3-701-903-11	HOLDER, PRINTED CIRCUIT BOARD		27	* 4-061-227-01	LABEL, INFORMATION [NH for USA-made set]	
				28	4-062-115-01	SCREW +P 3.5X20 TYPE 2	

6-2. PICTURE TUBE

- 7-685-663-71 +BVTP 4X16
- △ 7-685-881-09 +BVTT 4X8

The components identified by shading and mark △ are critical for safety. Replace only with part number specified.

Les composants identifiés par un tramé et une marque △ sont critiques pour la sécurité. Ne les remplacer que par une pièce portant le numéro spécifié.

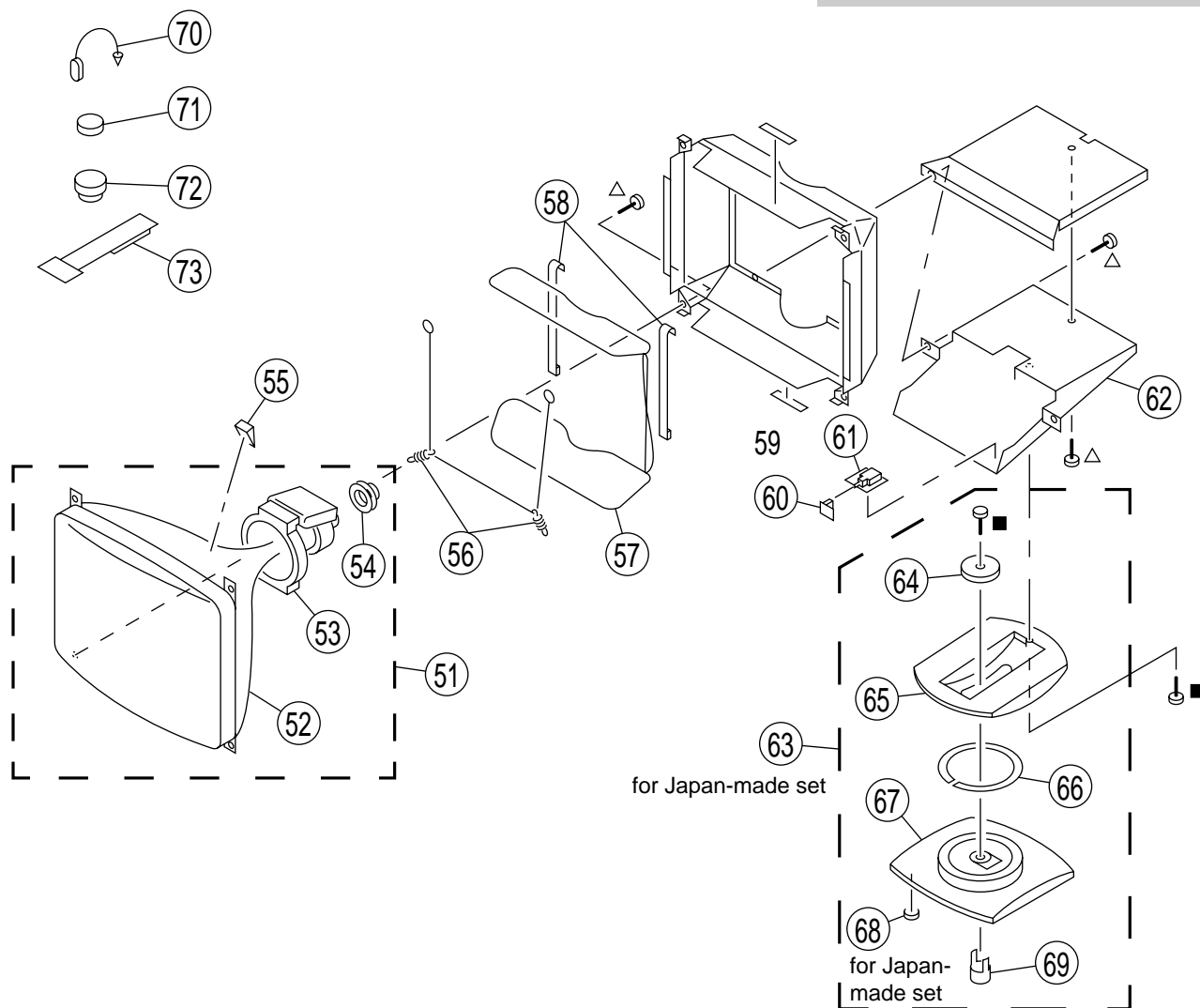

REF.NO.	PART NO.	DESCRIPTION	REMARK	REF.NO.	PART NO.	DESCRIPTION	REMARK
51	△ 8-736-148-91	ITC ASSY (20SPG-R3) [NH]	52-54	64	4-060-340-01	STOPPER (A) [NH for Japan-made set]	
51	△ 8-736-156-91	ITC ASSY (20SPG-RS2) [SH]	52-54	64	4-060-706-01	STOPPER (A) [NH for USA-made set]	
52	△ 8-736-148-05	PICTURE TUBE (20SPG) [NH]		65	* 4-060-383-11	SLIDER [NH for Japan-made set]	
52	△ 8-736-156-05	PICTURE TUBE (20SPG) [SH]		65	* 4-061-161-01	SLIDER [NH for USA-made set]	
53	△ 8-451-489-11	DEFLECTION YOKE (Y2OSHK2-M)		66	4-060-339-01	RING, TILT SWIVEL [NH for Japan-made set]	
54	△ 8-453-010-51	NECK ASSY, PICTURE TUBE (NA3014-M5) [NH]		66	4-060-705-01	RING, TILT SWIVEL [NH for USA-made set]	
55	4-040-897-01	SPACER, DY		67	* X-4034-923-1	BASE ASSY, STAND [NH for Japan-made set]	68
56	* 4-047-316-01	SPRING, TENSION [NH for Japan-made set]		67	* X-4034-964-1	BASE ASSY, STAND [NH for USA-made set]	
56	* 4-061-573-01	SPRING, TENSION [NH for USA-made set]		68	4-047-474-01	FOOT, RUBBER [NH for Japan-made set]	
57	△ 1-416-139-12	COIL, DEMAGNETIC		69	4-041-621-01	STOPPER (B) [NH for Japan-made set]	
58	* 4-057-193-01	BAND, DEGAUSE COIL		69	4-041-621-21	STOPPER (B) [NH for USA-made set]	
60	* 4-394-972-21	CAP, POWER		70	4-308-870-00	CLIP, LEAD WIRE	
61	* 8-933-253-00	POWER SW ASSY (J BOARD)		71	1-452-032-00	MAGNET, DISC ; 10 mmφ	
62	* 4-060-382-11	COVER, BOTTOM [NH for Japan-made set]		72	1-452-094-00	MAGNET, ROTABLE DISK; 15 mmφ	
62	* 4-061-163-01	COVER, BOTTOM [NH for USA-made set]		73	4-059-493-01	PERMALLOY (90), CONV.CORRECT	
63	* X-4034-924-1	STAND ASSY [NH for Japan-made set]	64-69				

6-3. PACKING MATERIALS

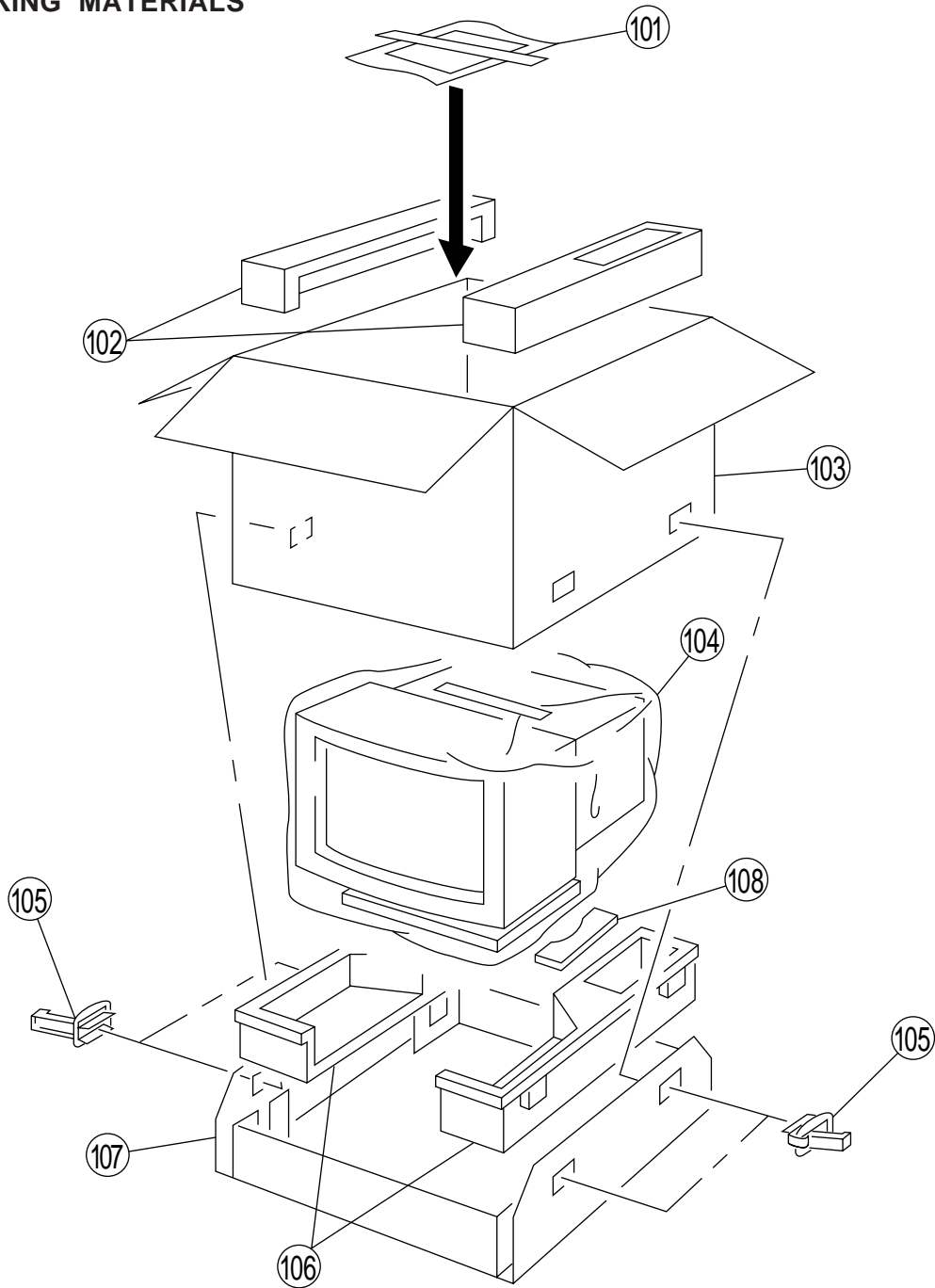

REF.NO.	PART NO.	DESCRIPTION	REMARK	REF.NO.	PART NO.	DESCRIPTION	REMARK
101	* 3-861-068-01	MANUAL, INSTRUCTIONS		104	* 4-041-927-31	BAG, POLYETHYLENE	
			[NH for Japan-made set]				[NH for Japan-made set]
101	* 3-861-068-11	MANUAL, INSTRUCTIONS		104	* 4-047-293-01	BAG, POLYETHYLENE	[NH for USA-made set]
			[for USA-made set]				
102	* 4-058-305-01	CUSHION (UPPER) (ASSY)		105	4-396-077-01	JOINT	
			[NH for Japan-made set]				
102	* 4-061-409-01	CUSHION (UPPER) (ASSY)	[NH for USA-made set]	106	* 4-058-306-01	CUSHION (LOWER) (ASSY)	
103	* 4-060-898-01	INDIVIDUAL CARTON					[NH for Japan-made set]
			[NH for Japan-made set]				
103	* 4-061-407-01	INDIVIDUAL CARTON	[NH for USA-made set]	106	* 4-061-410-02	CUSHION (LOWER) (ASSY)	[NH for USA-made set]
103	* 4-064-224-01	INDIVIDUAL CARTON	[SH]	107	* 4-058-304-01	TRAY	[NH for Japan-made set]
				107	* 4-061-408-01	TRAY	[NH for USA-made set]
				108	* 4-058-311-01	PAD, FOR TILT FIXING	
							[NH for Japan-made set]
				108	* 4-061-415-01	PAD, FOR TILT FIXING	[NH for USA-made set]

SECTION 7

GDM-4011P

ELECTRICAL PARTS LIST



NOTE:

The components identified by shading and mark Δ are critical for safety. Replace only with part number specified.

Les composants identifiés par un trame et une marque Δ sont critiques pour la sécurité. Ne les remplacer que par une pièce portant le numéro spécifié.

When indicating parts by reference number, please include the board name.

- All variable and adjustable resistors have characteristic curve B, unless otherwise noted.
- Items marked " * " are not stocked since they are seldom required for routine service. Some delay should be anticipated when ordering these items.

RESISTORS

- All resistors are in ohms
- F : nonflammable

CAPACITORS

- MF : μ F
- COILS
- UH : μ H

REF.NO.	PART NO.	DESCRIPTION	REMARK	REF.NO.	PART NO.	DESCRIPTION	REMARK
	* 8-933-250-00	VIDEO AMP MCB ASSY (A BOARD)					

	4-382-854-11	SCREW (M3X10), P, SW (+) (IC403)					
		<CAPACITOR>					
C101	1-164-232-11	CERAMIC CHIP 0.01MF	10% 50V	C301	1-164-232-11	CERAMIC CHIP 0.01MF	10% 50V
C102	1-104-664-11	ELECT 47MF	20% 25V	C302	1-104-664-11	ELECT 47MF	20% 25V
C103	1-164-232-11	CERAMIC CHIP 0.01MF	10% 50V	C303	1-164-232-11	CERAMIC CHIP 0.01MF	10% 50V
C104	1-104-664-11	ELECT 47MF	20% 25V	C304	1-104-664-11	ELECT 47MF	20% 25V
C105	1-164-232-11	CERAMIC CHIP 0.01MF	10% 50V				
C106	1-164-232-11	CERAMIC CHIP 0.01MF	10% 50V	C305	1-164-232-11	CERAMIC CHIP 0.01MF	10% 50V
C107	1-164-004-11	CERAMIC CHIP 0.1MF	10% 25V	C306	1-164-232-11	CERAMIC CHIP 0.01MF	10% 50V
C108	1-107-901-11	ELECT 0.47MF	20% 50V	C307	1-164-004-11	CERAMIC CHIP 0.1MF	10% 25V
C109	1-163-237-11	CERAMIC CHIP 27PF	5% 50V	C308	1-107-901-11	ELECT 0.47MF	20% 50V
C110	1-163-275-11	CERAMIC CHIP 0.001MF	5% 50V	C309	1-163-235-11	CERAMIC CHIP 22PF	5% 50V
C111	1-163-017-00	CERAMIC CHIP 0.0047MF	10% 50V				
C112	1-164-004-11	CERAMIC CHIP 0.1MF	10% 25V	C310	1-163-275-11	CERAMIC CHIP 0.001MF	5% 50V
C115	1-104-514-11	FILM 0.22MF	10% 250V	C311	1-163-017-00	CERAMIC CHIP 0.0047MF	10% 50V
C117	1-164-489-11	CERAMIC CHIP 0.22MF	10% 16V	C312	1-164-004-11	CERAMIC CHIP 0.1MF	10% 25V
C120	1-107-949-11	ELECT 2.2MF	20% 200V	C315	1-104-514-11	FILM 0.22MF	10% 250V
C121	1-164-232-11	CERAMIC CHIP 0.01MF	10% 50V	C317	1-164-489-11	CERAMIC CHIP 0.22MF	10% 16V
C122	1-164-004-11	CERAMIC CHIP 0.1MF	10% 25V				
C130	1-164-232-11	CERAMIC CHIP 0.01MF	10% 50V	C319	1-107-888-11	ELECT 47MF	20% 25V
C201	1-164-232-11	CERAMIC CHIP 0.01MF	10% 50V	C320	1-107-949-11	ELECT 2.2MF	20% 200V
C202	1-104-664-11	ELECT 47MF	20% 25V	C321	1-164-232-11	CERAMIC CHIP 0.01MF	10% 50V
C203	1-164-232-11	CERAMIC CHIP 0.01MF	10% 50V	C322	1-164-004-11	CERAMIC CHIP 0.1MF	10% 25V
C204	1-104-664-11	ELECT 47MF	20% 25V	C330	1-164-232-11	CERAMIC CHIP 0.01MF	10% 50V
C205	1-164-232-11	CERAMIC CHIP 0.01MF	10% 50V				
C206	1-164-232-11	CERAMIC CHIP 0.01MF	10% 50V	C401	1-126-964-11	ELECT 10MF	20% 50V
C207	1-164-004-11	CERAMIC CHIP 0.1MF	10% 25V	C402	1-104-664-11	ELECT 47MF	20% 25V
C208	1-107-901-11	ELECT 0.47MF	20% 50V	C403	1-104-664-11	ELECT 47MF	20% 25V
C209	1-163-235-11	CERAMIC CHIP 22PF	5% 50V	C404	1-126-964-11	ELECT 10MF	20% 50V
C210	1-163-275-11	CERAMIC CHIP 0.001MF	5% 50V	C405	1-163-227-11	CERAMIC CHIP 10PF	0.5PF 50V
C211	1-163-017-00	CERAMIC CHIP 0.0047MF	10% 50V				
C212	1-164-004-11	CERAMIC CHIP 0.1MF	10% 25V	C407	1-126-964-11	ELECT 10MF	20% 50V
C215	1-104-514-11	FILM 0.22MF	10% 250V	C408	1-164-232-11	CERAMIC CHIP 0.01MF	10% 50V
C217	1-164-489-11	CERAMIC CHIP 0.22MF	10% 16V	C409	1-163-235-11	CERAMIC CHIP 22PF	5% 50V
C220	1-107-949-11	ELECT 2.2MF	20% 200V	C410	1-164-232-11	CERAMIC CHIP 0.01MF	10% 50V
C221	1-164-232-11	CERAMIC CHIP 0.01MF	10% 50V	C412	1-164-232-11	CERAMIC CHIP 0.01MF	10% 50V
C222	1-164-004-11	CERAMIC CHIP 0.1MF	10% 25V				
C230	1-164-232-11	CERAMIC CHIP 0.01MF	10% 50V	C414	1-163-239-11	CERAMIC CHIP 33PF	5% 50V
				C415	1-128-562-11	ELECT 47MF	20% 100V
				C416	1-104-664-11	ELECT 47MF	20% 25V
				C417	1-115-349-51	CERAMIC 0.01MF	2KV
				C419	1-126-964-11	ELECT 10MF	20% 50V
				C420	1-107-929-11	ELECT 10MF	20% 100V
				C429	1-163-227-11	CERAMIC CHIP 10PF	0.5PF 50V
				C431	1-164-232-11	CERAMIC CHIP 0.01MF	10% 50V
				C434	1-162-318-11	CERAMIC 0.001MF	10% 500V
				C435	1-164-232-11	CERAMIC CHIP 0.01MF	10% 50V
				C436	1-163-243-11	CERAMIC CHIP 47PF	5% 50V
				C438	1-163-243-11	CERAMIC CHIP 47PF	5% 50V
				C440	1-163-243-11	CERAMIC CHIP 47PF	5% 50V
				C442	1-163-243-11	CERAMIC CHIP 47PF	5% 50V



Les composants identifiés per un trame et une marque Δ sont critiques pour la sécurité. Ne les remplacer que par une pièce portant le numéro spécifié.

The components identified by shading and mark Δ are critical for safety. Replace only with part number specified.

REF.NO.	PART NO.	DESCRIPTION	REMARK	REF.NO.	PART NO.	DESCRIPTION	REMARK
C444	1-163-243-11	CERAMIC CHIP 47PF	5% 50V	D202	8-719-062-51	DIODE 1PS226-115	
C446	1-164-004-11	CERAMIC CHIP 0.1MF	10% 25V	D203	8-719-404-49	DIODE MA111	
C447	1-164-004-11	CERAMIC CHIP 0.1MF	10% 25V	D204	8-719-052-12	DIODE 1SS376TE-17	
C448	1-164-004-11	CERAMIC CHIP 0.1MF	10% 25V	D205	8-719-052-12	DIODE 1SS376TE-17	
C450	1-163-235-11	CERAMIC CHIP 22PF	5% 50V	D206	8-719-052-12	DIODE 1SS376TE-17	
C451	1-126-964-11	ELECT 10MF	20% 50V	D207	8-719-052-12	DIODE 1SS376TE-17	
C452	1-164-232-11	CERAMIC CHIP 0.01MF	10% 50V	D301	8-719-062-51	DIODE 1PS226-115	
C453	1-164-232-11	CERAMIC CHIP 0.01MF	10% 50V	D302	8-719-062-51	DIODE 1PS226-115	
C454	1-104-665-11	ELECT 100MF	20% 25V	D303	8-719-404-49	DIODE MA111	
C455	1-163-243-11	CERAMIC CHIP 47PF	5% 50V	D304	8-719-052-12	DIODE 1SS376TE-17	
C457	1-164-232-11	CERAMIC CHIP 0.01MF	10% 50V	D305	8-719-052-12	DIODE 1SS376TE-17	
C459	1-115-350-51	CERAMIC 0.0047MF	2KV	D306	8-719-052-12	DIODE 1SS376TE-17	
C460	1-162-318-11	CERAMIC 0.001MF	10% 500V	D307	8-719-052-12	DIODE 1SS376TE-17	
C461	1-164-232-11	CERAMIC CHIP 0.01MF	10% 50V	D401	8-719-404-49	DIODE MA111	
C463	1-164-232-11	CERAMIC CHIP 0.01MF	10% 50V	D402	8-719-976-99	ZENER DIODE DTZ5.1B	
C464	1-107-906-11	ELECT 10MF	20% 50V	D404	8-719-052-12	DIODE 1SS376TE-17	
C465	1-107-906-11	ELECT 10MF	20% 50V	D408	8-719-404-49	DIODE MA111	
C466	1-126-964-11	ELECT 10MF	20% 50V				
C467	1-164-232-11	CERAMIC CHIP 0.01MF	10% 50V			<FERRITE BEAD>	
C468	1-126-964-11	ELECT 10MF	20% 50V	FB101	1-216-295-91	SHORT	0
C469	1-126-964-11	ELECT 10MF	20% 50V	FB201	1-216-295-91	SHORT	0
C471	1-162-318-11	CERAMIC 0.001MF	10% 500V	FB301	1-216-295-91	SHORT	0
C473	1-163-133-00	CERAMIC CHIP 470PF	5% 50V	FB403	1-412-911-31	FERRITE	0UH
C474	1-164-232-11	CERAMIC CHIP 0.01MF	10% 50V	FB405	1-412-911-31	FERRITE	0UH
C476	1-164-232-11	CERAMIC CHIP 0.01MF	10% 50V				
C478	1-115-350-51	CERAMIC 0.0047MF	2KV	FB406	1-412-911-31	FERRITE	0UH
C479	1-163-133-00	CERAMIC CHIP 470PF	5% 50V				
C481	1-164-232-11	CERAMIC CHIP 0.01MF	10% 50V			<IC>	
C482	1-115-339-11	CERAMIC CHIP 0.1MF	10% 50V	IC401	8-759-522-86	IC M52755FP-TP	
C483	1-115-339-11	CERAMIC CHIP 0.1MF	10% 50V	IC402	8-759-468-63	IC M52722P	
C484	1-162-318-11	CERAMIC 0.001MF	10% 500V	IC403	8-749-013-74	IC FA4111	
C485	1-107-652-11	ELECT 10MF	20% 200V	IC404	8-759-492-78	IC LSC4380DW2EL	
C486	1-164-232-11	CERAMIC CHIP 0.01MF	10% 50V	IC405	8-759-510-71	IC BA10358F-E2	
C487	1-126-961-11	ELECT 2.2MF	20% 50V				
C488	1-104-664-11	ELECT 47MF	20% 25V	IC406	8-759-231-58	IC TA7812S	
C489	1-164-004-11	CERAMIC CHIP 0.1MF	10% 25V	IC408	8-759-239-14	IC TA78L05S	
				IC409	8-759-502-82	IC LM324M	
				IC410	8-759-635-27	IC M62352GP-75E	
		<CONNECTOR>					
		CN401*1-564-521-11 PLUG, CONNECTOR 6P				<COIL>	
		CN402*1-564-522-11 PLUG, CONNECTOR 7P		L101	1-412-478-11	INDUCTOR	0.15UH
		CN403 1-564-523-11 PLUG, CONNECTOR 8P		L201	1-412-478-11	INDUCTOR	0.15UH
		CN405 1-564-524-11 PLUG, CONNECTOR 9P		L301	1-412-478-11	INDUCTOR	0.15UH
		CN406*1-766-179-11 PIN, CONNECTOR (PC BOARD) 2P		L401	1-408-421-00	INDUCTOR	100UH
		CN407*1-564-522-11 PLUG, CONNECTOR 7P				<IC LINK>	
		<DIODE>				PS401Δ1-533-590-31 LINK, IC (1A/90V AC, 60V DC)	
D101	8-719-062-51	DIODE 1PS226-115				<TRANSISTOR>	
D102	8-719-062-51	DIODE 1PS226-115		Q101	8-729-112-65	TRANSISTOR 2SA1462-Y33	
D103	8-719-404-49	DIODE MA111		Q105	8-729-041-66	TRANSISTOR 2SC4015TV2	
D104	8-719-052-12	DIODE 1SS376TE-17		Q106	8-729-200-17	TRANSISTOR 2SA1091-O	
D105	8-719-052-12	DIODE 1SS376TE-17		Q201	8-729-112-65	TRANSISTOR 2SA1462-Y33	
D106	8-719-052-12	DIODE 1SS376TE-17		Q205	8-729-041-66	TRANSISTOR 2SC4015TV2	
D107	8-719-052-12	DIODE 1SS376TE-17					
D201	8-719-062-51	DIODE 1PS226-115					



REF.NO.	PART NO.	DESCRIPTION	REMARK	REF.NO.	PART NO.	DESCRIPTION	REMARK
Q206	8-729-200-17	TRANSISTOR 2SA1091-O		R204	1-216-029-00	RES,CHIP 150	5% 1/10W
Q301	8-729-112-65	TRANSISTOR 2SA1462-Y33		R205	1-216-017-91	RES,CHIP 47	5% 1/10W
Q305	8-729-041-66	TRANSISTOR 2SC4015TV2		R206	1-216-017-91	RES,CHIP 47	5% 1/10W
Q306	8-729-200-17	TRANSISTOR 2SA1091-O		R208	1-216-099-00	RES,CHIP 120K	5% 1/10W
Q401	8-729-216-22	TRANSISTOR 2SA1162-G					
Q402	8-729-120-28	TRANSISTOR 2SC1623-L5L6		R209	1-216-105-91	RES,CHIP 220K	5% 1/10W
Q403	8-729-216-22	TRANSISTOR 2SA1162-G		R210	1-216-295-91	SHORT 0	
Q404	8-729-901-00	TRANSISTOR DTC124EK		R211	1-216-057-00	RES,CHIP 2.2K	5% 1/10W
Q405	8-729-120-28	TRANSISTOR 2SC1623-L5L6		R212	1-216-619-11	METAL CHIP 47	0.50%1/10W
Q406	8-729-027-31	TRANSISTOR DTA124EKA-T146		R213	1-216-009-00	RES,CHIP 22	5% 1/10W
Q410	8-729-020-07	TRANSISTOR 2SC4686A(LBSONY)		R214	1-216-035-00	RES,CHIP 270	5% 1/10W
Q411	8-729-020-07	TRANSISTOR 2SC4686A(LBSONY)		R215	1-216-035-00	RES,CHIP 270	5% 1/10W
		<RESISTOR>		R216	1-216-017-91	RES,CHIP 47	5% 1/10W
R101	1-215-395-00	METAL 82	1% 1/4W	R217	1-216-065-00	RES,CHIP 4.7K	5% 1/10W
R102	1-216-029-00	RES,CHIP 150	5% 1/10W	R218	1-216-061-00	RES,CHIP 3.3K	5% 1/10W
R103	1-215-395-00	METAL 82	1% 1/4W	R219	1-216-009-00	RES,CHIP 22	5% 1/10W
R104	1-216-029-00	RES,CHIP 150	5% 1/10W	R220	1-216-097-91	RES,CHIP 100K	5% 1/10W
R105	1-216-017-91	RES,CHIP 47	5% 1/10W	R221	1-216-097-91	RES,CHIP 100K	5% 1/10W
R106	1-216-017-91	RES,CHIP 47	5% 1/10W	R222	1-216-031-00	RES,CHIP 180	5% 1/10W
R108	1-216-099-00	RES,CHIP 120K	5% 1/10W	R223	1-216-031-00	RES,CHIP 180	5% 1/10W
R109	1-216-105-91	RES,CHIP 220K	5% 1/10W	R224	1-219-497-11	CARBON 22	5% 1/2W
R110	1-216-295-91	SHORT 0		R225	1-216-693-11	METAL CHIP 56K	0.50%1/10W
R111	1-216-057-00	RES,CHIP 2.2K	5% 1/10W	R226	1-216-097-91	RES,CHIP 100K	5% 1/10W
R112	1-216-619-11	METAL CHIP 47	0.50%1/10W	R227	1-216-035-00	RES,CHIP 270	5% 1/10W
R113	1-216-009-00	RES,CHIP 22	5% 1/10W	R228	1-216-121-91	RES,CHIP 1M	5% 1/10W
R114	1-216-035-00	RES,CHIP 270	5% 1/10W	R229	1-218-776-11	METAL CHIP 1M	0.50%1/10W
R115	1-216-035-00	RES,CHIP 270	5% 1/10W	R230	1-216-097-91	RES,CHIP 100K	5% 1/10W
R116	1-216-017-91	RES,CHIP 47	5% 1/10W	R231	1-216-057-00	RES,CHIP 2.2K	5% 1/10W
R117	1-216-065-00	RES,CHIP 4.7K	5% 1/10W	R232	1-216-035-00	RES,CHIP 270	5% 1/10W
R118	1-216-061-00	RES,CHIP 3.3K	5% 1/10W	R233	1-216-049-91	RES,CHIP 1K	5% 1/10W
R119	1-216-009-00	RES,CHIP 22	5% 1/10W	R234	1-216-097-91	RES,CHIP 100K	5% 1/10W
R120	1-216-097-91	RES,CHIP 100K	5% 1/10W	R235	1-216-037-00	RES,CHIP 330	5% 1/10W
R121	1-216-097-91	RES,CHIP 100K	5% 1/10W	R236	1-216-097-91	RES,CHIP 100K	5% 1/10W
R122	1-216-031-00	RES,CHIP 180	5% 1/10W	R237	1-216-097-91	RES,CHIP 100K	5% 1/10W
R123	1-216-031-00	RES,CHIP 180	5% 1/10W	R239	1-216-073-00	RES,CHIP 10K	5% 1/10W
R124	1-219-497-11	CARBON 22	5% 1/2W	R267	1-216-121-91	RES,CHIP 1M	5% 1/10W
R125	1-216-693-11	METAL CHIP 56K	0.50%1/10W	R301	1-215-395-00	METAL 82	1% 1/4W
R126	1-216-097-91	RES,CHIP 100K	5% 1/10W	R302	1-216-029-00	RES,CHIP 150	5% 1/10W
R127	1-216-035-00	RES,CHIP 270	5% 1/10W	R303	1-215-395-00	METAL 82	1% 1/4W
R128	1-216-121-91	RES,CHIP 1M	5% 1/10W	R304	1-216-029-00	RES,CHIP 150	5% 1/10W
R129	1-218-776-11	METAL CHIP 1M	0.50%1/10W	R305	1-216-017-91	RES,CHIP 47	5% 1/10W
R130	1-216-097-91	RES,CHIP 100K	5% 1/10W	R306	1-216-017-91	RES,CHIP 47	5% 1/10W
R131	1-216-057-00	RES,CHIP 2.2K	5% 1/10W	R308	1-216-099-00	RES,CHIP 120K	5% 1/10W
R132	1-216-035-00	RES,CHIP 270	5% 1/10W	R309	1-216-105-91	RES,CHIP 220K	5% 1/10W
R133	1-216-049-91	RES,CHIP 1K	5% 1/10W	R310	1-216-295-91	SHORT 0	
R134	1-216-097-91	RES,CHIP 100K	5% 1/10W	R311	1-216-057-00	RES,CHIP 2.2K	5% 1/10W
R135	1-216-037-00	RES,CHIP 330	5% 1/10W	R312	1-216-619-11	METAL CHIP 47	0.50%1/10W
R136	1-216-097-91	RES,CHIP 100K	5% 1/10W	R313	1-216-009-00	RES,CHIP 22	5% 1/10W
R137	1-216-097-91	RES,CHIP 100K	5% 1/10W	R314	1-216-035-00	RES,CHIP 270	5% 1/10W
R139	1-216-073-00	RES,CHIP 10K	5% 1/10W	R315	1-216-035-00	RES,CHIP 270	5% 1/10W
R167	1-216-121-91	RES,CHIP 1M	5% 1/10W	R316	1-216-017-91	RES,CHIP 47	5% 1/10W
R201	1-215-395-00	METAL 82	1% 1/4W	R317	1-216-065-00	RES,CHIP 4.7K	5% 1/10W
R202	1-216-029-00	RES,CHIP 150	5% 1/10W	R318	1-216-061-00	RES,CHIP 3.3K	5% 1/10W
R203	1-215-395-00	METAL 82	1% 1/4W	R319	1-216-009-00	RES,CHIP 22	5% 1/10W
				R320	1-216-097-91	RES,CHIP 100K	5% 1/10W
				R321	1-216-097-91	RES,CHIP 100K	5% 1/10W
				R322	1-216-031-00	RES,CHIP 180	5% 1/10W



Les composants identifiés per un trame et une marque Δ sont critiques pour la sécurité. Ne les remplacer que par une pièce portant le numéro spécifié.

The components identified by shading and mark Δ are critical for safety. Replace only with part number specified.

REF.NO.	PART NO.	DESCRIPTION	REMARK	REF.NO.	PART NO.	DESCRIPTION	REMARK
R323	1-216-031-00	RES,CHIP	180 5% 1/10W	R450	1-219-720-11	METAL	10M 5% 1W
R324	1-219-497-11	CARBON	22 5% 1/2W	R451	1-211-885-21	METAL	2.2M 5% 1W
R325	1-216-693-11	METAL CHIP	56K 0.50%1/10W	R453	1-216-057-00	RES,CHIP	2.2K 5% 1/10W
R326	1-216-097-91	RES,CHIP	100K 5% 1/10W	R455	1-216-089-91	RES,CHIP	47K 5% 1/10W
R327	1-216-035-00	RES,CHIP	270 5% 1/10W	R456	1-216-095-00	RES,CHIP	82K 5% 1/10W
R328	1-216-121-91	RES,CHIP	1M 5% 1/10W	R457	1-216-073-00	RES,CHIP	10K 5% 1/10W
R329	1-218-776-11	METAL CHIP	1M 0.50%1/10W	R458	1-211-885-21	METAL	2.2M 5% 1W
R330	1-216-097-91	RES,CHIP	100K 5% 1/10W	R459	1-219-720-11	METAL	10M 5% 1W
R331	1-216-057-00	RES,CHIP	2.2K 5% 1/10W	R462	1-216-089-91	RES,CHIP	47K 5% 1/10W
R332	1-216-035-00	RES,CHIP	270 5% 1/10W	R463	1-216-095-00	RES,CHIP	82K 5% 1/10W
R333	1-216-049-91	RES,CHIP	1K 5% 1/10W	R464	1-216-057-00	RES,CHIP	2.2K 5% 1/10W
R334	1-216-097-91	RES,CHIP	100K 5% 1/10W	R466	1-216-675-11	METAL CHIP	10K 0.50%1/10W
R335	1-216-037-00	RES,CHIP	330 5% 1/10W	R470	1-216-065-00	RES,CHIP	4.7K 5% 1/10W
R336	1-216-097-91	RES,CHIP	100K 5% 1/10W	R471	1-216-069-00	RES,CHIP	6.8K 5% 1/10W
R337	1-216-097-91	RES,CHIP	100K 5% 1/10W	R473	1-216-073-00	RES,CHIP	10K 5% 1/10W
R339	1-216-073-00	RES,CHIP	10K 5% 1/10W	R475	1-216-073-00	RES,CHIP	10K 5% 1/10W
R367	1-216-121-91	RES,CHIP	1M 5% 1/10W	R477	1-216-081-00	RES,CHIP	22K 5% 1/10W
R406	1-216-049-91	RES,CHIP	1K 5% 1/10W	R478	1-249-381-11	CARBON	1 5% 1/4W F
R407	1-216-089-91	RES,CHIP	47K 5% 1/10W	R479	1-249-381-11	CARBON	1 5% 1/4W F
R408	1-216-097-91	RES,CHIP	100K 5% 1/10W	R480	1-249-381-11	CARBON	1 5% 1/4W F
R409	1-216-049-91	RES,CHIP	1K 5% 1/10W	<VARIABLE RESISTOR>			
R410	1-216-049-91	RES,CHIP	1K 5% 1/10W	RV401	Δ 1-223-410-21	RES, ADJ, METAL FILM	110M (H.STAT)
R411	1-216-065-00	RES,CHIP	4.7K 5% 1/10W	<SPARK GAP>			
R412	1-216-053-00	RES,CHIP	1.5K 5% 1/10W	SG101	1-517-499-21	GAP, SPARK	
R413	1-216-065-00	RES,CHIP	4.7K 5% 1/10W	SG201	1-517-499-21	GAP, SPARK	
R415	1-216-065-00	RES,CHIP	4.7K 5% 1/10W	SG301	1-517-499-21	GAP, SPARK	
R416	1-216-049-91	RES,CHIP	1K 5% 1/10W	SG402	1-519-422-11	GAP, SPARK	
R417	1-216-089-91	RES,CHIP	47K 5% 1/10W	SG403	1-517-499-21	GAP, SPARK	
R418	1-260-127-11	CARBON	220K 5% 1/2W	SG405	1-519-422-11	GAP, SPARK	
R419	1-216-687-11	METAL CHIP	33K 0.50%1/10W	<SOCKET>			
R420	1-216-691-11	METAL CHIP	47K 0.50%1/10W	SK401	Δ 1-251-116-12	SOCKET, PICTURE TUBE	
R421	1-216-103-00	RES,CHIP	180K 5% 1/10W	*****			
R422	1-216-025-91	RES,CHIP	100 5% 1/10W	* 8-933-252-00 SWITCHING REGULATOR UNIT (G BOARD)			
R423	1-249-441-11	CARBON	100K 5% 1/4W	*****			
R424	1-216-025-91	RES,CHIP	100 5% 1/10W	4-382-854-11 SCREW (M3X10), P, SW (+)			
R425	1-216-017-91	RES,CHIP	47 5% 1/10W	(Q610, Q611, Q640, D610, D672)			
R426	1-216-025-91	RES,CHIP	100 5% 1/10W	<CAPACITOR>			
R427	1-216-025-91	RES,CHIP	100 5% 1/10W	C601	Δ 1-113-900-51	CERAMIC	470PF 10% 250V
R428	1-216-049-91	RES,CHIP	1K 5% 1/10W	C602	Δ 1-113-900-51	CERAMIC	470PF 10% 250V
R429	1-216-025-91	RES,CHIP	100 5% 1/10W	C603	Δ 1-107-533-51	FILM	1MF 20% 250V
R430	1-216-025-91	RES,CHIP	100 5% 1/10W	C604	Δ 1-107-533-51	FILM	1MF 20% 250V
R431	1-216-025-91	RES,CHIP	100 5% 1/10W	C605	1-113-926-11	CERAMIC	0.0047MF 250V
R432	1-216-025-91	RES,CHIP	100 5% 1/10W	C606	1-113-926-11	CERAMIC	0.0047MF 250V
R433	1-216-025-91	RES,CHIP	100 5% 1/10W	C610	1-137-479-11	FILM	1MF 10% 400V
R434	1-216-065-00	RES,CHIP	4.7K 5% 1/10W	C611	1-113-707-11	ELECT(BLOCK)	220MF 20% 450V
R435	1-216-121-91	RES,CHIP	1M 5% 1/10W				
R436	1-216-067-00	RES,CHIP	5.6K 5% 1/10W				
R438	1-216-053-00	RES,CHIP	1.5K 5% 1/10W				
R439	1-216-053-00	RES,CHIP	1.5K 5% 1/10W				
R441	1-216-025-91	RES,CHIP	100 5% 1/10W				
R442	1-216-659-11	METAL CHIP	2.2K 0.50%1/10W				
R443	1-216-041-00	RES,CHIP	470 5% 1/10W				
R444	1-216-057-00	RES,CHIP	2.2K 5% 1/10W				
R445	1-216-057-00	RES,CHIP	2.2K 5% 1/10W				
R446	1-216-025-91	RES,CHIP	100 5% 1/10W				
R448	1-260-127-11	CARBON	220K 5% 1/2W				

The components identified by shading and mark Δ are critical for safety. Replace only with part number specified.

Les composants identifiés par un trame et une marque Δ sont critiques pour la sécurité. Ne les remplacer que par une pièce portant le numéro spécifié.



REF.NO.	PART NO.	DESCRIPTION	REMARK	REF.NO.	PART NO.	DESCRIPTION	REMARK
C616	1-104-664-11	ELECT	47MF 20% 25V	D663	8-719-110-31	ZENER DIODE RD12ESB2	
C621	1-136-205-11	FILM	0.022MF 10% 630V	D664	8-719-911-19	DIODE 1SS119-25	
C640	1-165-127-11	CERAMIC	470PF 10% 500V	D665	8-719-110-35	ZENER DIODE RD13ESB1	
C641	1-165-127-11	CERAMIC	470PF 10% 500V	D670	8-719-064-49	DIODE D4SBL40	
C642	1-136-169-00	FILM	0.22MF 5% 50V	D671	8-719-510-64	DIODE S2LA20F	
C643	1-136-169-00	FILM	0.22MF 5% 50V	D672	8-719-052-91	DIODE D4SBS4-F	
C644	1-165-127-11	CERAMIC	470PF 10% 500V	D673	8-719-022-97	DIODE D2S4MF	
C645	1-136-165-00	FILM	0.1MF 5% 50V	D674	8-719-022-97	DIODE D2S4MF	
C646	1-136-165-00	FILM	0.1MF 5% 50V	D677	8-719-911-19	DIODE 1SS119-25	
C647	1-129-718-00	FILM	0.022MF 5% 630V	D678	8-719-911-19	DIODE 1SS119-25	
C660	1-115-779-11	ELECT	120MF 20% 25V	D680	8-719-911-19	DIODE 1SS119-25	
C661	1-126-933-11	ELECT	100MF 20% 16V	D681	8-719-911-19	DIODE 1SS119-25	
C662	1-137-399-11	FILM	0.1MF 5% 50V	D682	8-719-510-64	DIODE S2LA20F	
C663	1-126-965-11	ELECT	22MF 20% 50V	D683	8-719-911-19	DIODE 1SS119-25	
C670	1-137-370-11	FILM	0.01MF 5% 50V	D684	8-719-110-49	ZENER DIODE RD18ESB2	
C671	1-107-955-11	ELECT	100MF 20% 200V	D691	8-719-028-45	DIODE D2L20U	
C672	1-107-950-11	ELECT	3.3MF 20% 200V	D692	8-719-911-19	DIODE 1SS119-25	
C673	1-107-935-11	ELECT	330MF 20% 100V	<FUSE>			
C674	1-107-928-11	ELECT	4.7MF 20% 100V	F601 Δ 1-576-233-11	FUSE (H.B.C.) (6.3A/250V)		
C675	1-107-890-11	ELECT	2200MF 20% 25V	1-533-223-11	HOLDER, FUSE ; F601		
C676	1-107-888-11	ELECT	47MF 20% 25V	<FERRITE BEAD>			
C677	1-107-890-11	ELECT	2200MF 20% 25V	FB610	1-410-396-41	FERRITE 0.45UH	
C678	1-107-888-11	ELECT	47MF 20% 25V	FB611	1-410-396-41	FERRITE 0.45UH	
C679	1-126-927-11	ELECT	2200MF 20% 10V	FB612	1-410-396-41	FERRITE 0.45UH	
C680	1-126-927-11	ELECT	2200MF 20% 10V	<IC>			
C681	1-126-963-11	ELECT	4.7MF 20% 50V	IC610	8-749-013-77	IC TME757	
C682	1-126-963-11	ELECT	4.7MF 20% 50V	IC630	8-749-012-49	IC DM-57N	
C683	1-164-646-11	CERAMIC	2200PF 10% 500V	IC660	8-759-469-10	IC TOP223PF1	
C684	1-137-370-11	FILM	0.01MF 5% 50V	IC690	8-749-013-76	IC PQ6RD83B	
C685	1-126-967-11	ELECT	47MF 20% 50V	<COIL>			
C690	1-128-528-11	ELECT	470MF 20% 16V	L610	1-416-297-11	COIL, CHOKE 500UH	
C691	1-107-888-11	ELECT	47MF 20% 25V	L611	1-412-529-11	INDUCTOR 22UH	
C692	1-115-737-11	ELECT	0.001F 20% 10V	L612	1-412-529-11	INDUCTOR 22UH	
C693	1-137-399-11	FILM	0.1MF 5% 50V	L670	1-412-529-11	INDUCTOR 22UH	
C694	1-107-888-11	ELECT	47MF 20% 25V	L671	1-412-529-11	INDUCTOR 22UH	
<CONNECTOR>				L672	1-412-529-11	INDUCTOR 22UH	
CN603*	1-580-689-11	PIN, CONNECTOR (PC BOARD) 4P		L673	1-412-529-11	INDUCTOR 22UH	
CN604	1-691-960-11	PIN, CONNECTOR (PC BOARD) 3P		L691	1-412-529-11	INDUCTOR 22UH	
CN605	1-691-960-11	PIN, CONNECTOR (PC BOARD) 3P		L692	1-412-529-11	INDUCTOR 22UH	
CN671*	1-564-514-11	PLUG, CONNECTOR 11P		<PHOTO COUPLER>			
CN672*	1-564-512-11	PLUG, CONNECTOR 9P		PH680	8-749-010-64	PHOTO COUPLER PC123F2	
CN673*	1-564-508-11	PLUG, CONNECTOR 5P		<IC LINK>			
<DIODE>				PS674 Δ 1-533-593-31	LINK, IC (2A/90V AC, 60V DC)		
D610	8-719-510-53	DIODE D4SB60L					
D611	8-719-029-04	DIODE D5L60					
D612	8-719-304-63	DIODE RM11C					
D614	8-719-911-19	DIODE 1SS119-25					
D617	8-719-911-19	DIODE 1SS119-25					
D640	8-719-911-19	DIODE 1SS119-25					
D660	8-719-066-51	DIODE P6KE170AG23					
D661	8-719-979-64	DIODE UF4005PKG23					
D662	8-719-058-92	DIODE AG01A-V1					



Les composants identifiés par un tramé et une marque Δ sont critiques pour la sécurité. Ne les remplacer que par une pièce portant le numéro spécifié.

The components identified by shading and mark Δ are critical for safety. Replace only with part number specified.

REF.NO.	PART NO.	DESCRIPTION	REMARK	REF.NO.	PART NO.	DESCRIPTION	REMARK
<TRANSISTOR>				R673	1-249-413-11	CARBON	470 5% 1/4W F
Q610	8-729-041-65	TRANSISTOR 2SK2195F04		R674	1-249-377-11	CARBON	0.47 5% 1/4W F
Q615	8-729-119-76	TRANSISTOR 2SA1175-HFE		R675	1-260-292-11	CARBON	1 5% 1/2W
Q640	8-729-039-65	TRNSISTOR MX0541B-F		R680	1-249-429-11	CARBON	10K 5% 1/4W
Q641	8-729-119-76	TRANSISTOR 2SA1175-HFE		R681	1-249-417-11	CARBON	1K 5% 1/4W
Q642	8-729-119-78	TRANSISTOR 2SC2785-HFE		R682	1-249-425-11	CARBON	4.7K 5% 1/4W
Q660	8-729-119-78	TRANSISTOR 2SC2785-HFE		R683	1-247-807-31	CARBON	100 5% 1/4W
Q680	8-729-119-78	TRANSISTOR 2SC2785-HFE		R685	1-249-429-11	CARBON	10K 5% 1/4W
Q681	8-729-230-45	TRANSISTOR 2SC2458-YGR		R686	1-249-417-11	CARBON	1K 5% 1/4W
Q682	8-729-119-76	TRANSISTOR 2SA1175-HFE		R687	1-249-417-11	CARBON	1K 5% 1/4W
Q683	8-729-119-76	TRANSISTOR 2SA1175-HFE		R688	1-249-429-11	CARBON	10K 5% 1/4W
Q690	8-729-119-78	TRANSISTOR 2SC2785-HFE		R689	1-249-425-11	CARBON	4.7K 5% 1/4W
<RESISTOR>				R690	1-249-393-11	CARBON	10 5% 1/4W F
R601	Δ 1-220-825-11	CARBON	330K 5% 1/2W	R692	1-260-085-11	CARBON	68 5% 1/2W
R604	1-260-089-11	CARBON	150 5% 1/2W	R693	1-249-425-11	CARBON	4.7K 5% 1/4W
R605	1-247-863-91	CARBON	22K 5% 1/4W	R694	1-249-429-11	CARBON	10K 5% 1/4W
R610	1-207-616-00	WIREWOUND	0.47 10% 2W F	<RELAY>			
R611	1-207-616-00	WIREWOUND	0.47 10% 2W F	RY601 Δ 1-515-669-21 RELAY			
R612	1-260-123-11	CARBON	100K 5% 1/2W	RY602 1-755-031-11 RELAY			
R613	1-260-123-11	CARBON	100K 5% 1/2W	<TRANSFORMER>			
R619	1-215-485-00	METAL	470K 1% 1/4W	T601 Δ 1-429-180-11 TRANSFORMER, LINE FILTER			
R620	1-215-483-00	METAL	390K 1% 1/4W	T640 Δ 1-431-415-11 TRANSFORMER, CONVERTER (PIT)			
R621	1-215-483-00	METAL	390K 1% 1/4W	T641 1-429-992-11 TRANSFORMER, CONVERTER (PRT)			
R625	1-249-393-11	CARBON	10 5% 1/4W	T660 1-431-416-11 TRANSFORMER, CONVERTER (SRT)			
R626	1-249-429-11	CARBON	10K 5% 1/4W	<THERMISTOR>			
R627	1-215-485-00	METAL	470K 1% 1/4W	TH601 Δ 1-809-260-11 THERMISTOR, POWER			
R628	1-215-481-00	METAL	330K 1% 1/4W	THP601 1-809-827-11 THERMISTOR, POSITIVE			
R629	1-215-463-00	METAL	56K 1% 1/4W	<VARISTOR>			
R630	1-247-863-91	CARBON	22K 5% 1/4W	VDR601 Δ 1-801-268-31 VARISTOR TNR14V471K660			
R631	1-249-407-11	CARBON	150 5% 1/4W	VDR602 1-810-622-11 VARISTOR			
R632	1-249-429-11	CARBON	10K 5% 1/4W	VDR640 1-810-974-21 VARISTOR TNR10V431K660			
R633	1-215-481-00	METAL	330K 1% 1/4W	*****			
R635	1-249-429-11	CARBON	10K 5% 1/4W	* 8-933-251-00 DEFLECTION MCB ASSY (D BOARD)			
R640	1-220-926-11	FUSIBLE	0.47 10% 1/2W F	*****			
R641	1-218-642-11	METAL OXIDE	100K 5% 1W F	2-371-561-00 BUSHING (P), INSULATING (IC502)			
R642	1-218-642-11	METAL OXIDE	100K 5% 1W F	4-047-285-01 SHEET, INSULATING (Q508)			
R643	1-247-863-91	CARBON	22K 5% 1/4W	4-060-842-01 SHEET, INSULATING (IC502)			
R644	1-247-887-00	CARBON	220K 5% 1/4W	4-060-844-01 SHEET, INSULATING (IC702)			
R645	1-247-863-91	CARBON	22K 5% 1/4W	4-382-854-11 SCREW (M3X10), P, SW (+)			
R646	1-249-429-11	CARBON	10K 5% 1/4W	<CAPACITOR>			
R647	1-249-441-11	CARBON	100K 5% 1/4W	C001 1-164-232-11 CERAMIC CHIP 0.01MF 10% 50V			
R648	1-249-385-11	CARBON	2.2 5% 1/4W	C002 1-163-009-11 CERAMIC CHIP 0.001MF 10% 50V			
R649	1-218-642-11	METAL OXIDE	100K 5% 1W F	C003 1-163-017-00 CERAMIC CHIP 0.0047MF 10% 50V			
R650	1-218-642-11	METAL OXIDE	100K 5% 1W F	C004 1-164-232-11 CERAMIC CHIP 0.01MF 10% 50V			
R651	1-249-385-11	CARBON	2.2 5% 1/4W				
R652	1-212-942-00	FUSIBLE	2.2 5% 1/2W F				
R655	1-249-429-11	CARBON	10K 5% 1/4W				
R661	1-249-389-11	CARBON	4.7 5% 1/4W F				
R662	1-249-429-11	CARBON	10K 5% 1/4W				
R663	1-249-429-11	CARBON	10K 5% 1/4W				
R664	1-249-389-11	CARBON	4.7 5% 1/4W				
R671	1-247-895-91	CARBON	470K 5% 1/4W				
R672	1-249-417-11	CARBON	1K 5% 1/4W				



REF.NO.	PART NO.	DESCRIPTION	REMARK	REF.NO.	PART NO.	DESCRIPTION	REMARK
C005	1-164-232-11	CERAMIC CHIP 0.01MF	10% 50V	C063	1-137-399-11	FILM 0.1MF	5% 50V
C006	1-126-960-11	ELECT 1MF	20% 50V	C064	1-137-399-11	FILM 0.1MF	5% 50V
C007	1-164-232-11	CERAMIC CHIP 0.01MF	10% 50V	C065	1-126-965-11	ELECT 22MF	20% 50V
C008	1-164-004-11	CERAMIC CHIP 0.1MF	10% 25V	C066	1-164-232-11	CERAMIC CHIP 0.01MF	10% 50V
C009	1-164-004-11	CERAMIC CHIP 0.1MF	10% 25V	C067	1-163-243-11	CERAMIC CHIP 47PF	5% 50V
C010	1-163-235-11	CERAMIC CHIP 22PF	5% 50V	C068	1-126-964-11	ELECT 10MF	20% 50V
C011	1-163-235-11	CERAMIC CHIP 22PF	5% 50V	C069	1-164-232-11	CERAMIC CHIP 0.01MF	10% 50V
C012	1-164-004-11	CERAMIC CHIP 0.1MF	10% 25V	C071	1-164-232-11	CERAMIC CHIP 0.01MF	10% 50V
C013	1-126-967-11	ELECT 47MF	20% 50V	C072	1-126-960-11	ELECT 1MF	20% 50V
C014	1-107-914-11	ELECT 1000MF	20% 25V	C074	1-163-009-11	CERAMIC CHIP 0.001MF	10% 50V
C015	1-107-914-11	ELECT 1000MF	20% 25V	C075	1-164-232-11	CERAMIC CHIP 0.01MF	10% 50V
C016	1-163-009-11	CERAMIC CHIP 0.001MF	10% 50V	C076	1-163-809-11	CERAMIC CHIP 0.047MF	10% 25V
C017	1-164-004-11	CERAMIC CHIP 0.1MF	10% 25V	C078	1-164-004-11	CERAMIC CHIP 0.1MF	10% 25V
C018	1-164-004-11	CERAMIC CHIP 0.1MF	10% 25V	C079	1-126-967-11	ELECT 47MF	20% 50V
C019	1-126-967-11	ELECT 47MF	20% 50V	C080	1-126-967-11	ELECT 47MF	20% 50V
C020	1-164-232-11	CERAMIC CHIP 0.01MF	10% 50V	C081	1-164-232-11	CERAMIC CHIP 0.01MF	10% 50V
C021	1-163-023-00	CERAMIC CHIP 0.015MF	10% 50V	C082	1-126-965-11	ELECT 22MF	20% 50V
C023	1-163-009-11	CERAMIC CHIP 0.001MF	10% 50V	C083	1-126-964-11	ELECT 10MF	20% 50V
C024	1-164-232-11	CERAMIC CHIP 0.01MF	10% 50V	C084	1-164-004-11	CERAMIC CHIP 0.1MF	10% 25V
C025	1-126-960-11	ELECT 1MF	20% 50V	C085	1-164-232-11	CERAMIC CHIP 0.01MF	10% 50V
C026	1-137-372-11	FILM 0.022MF	5% 50V	C086	1-126-964-11	ELECT 10MF	20% 50V
C027	1-164-004-11	CERAMIC CHIP 0.1MF	10% 25V	C087	1-164-004-11	CERAMIC CHIP 0.1MF	10% 25V
C028	1-164-695-11	CERAMIC CHIP 0.0022MF	5% 50V	C092	1-164-232-11	CERAMIC CHIP 0.01MF	10% 50V
C029	1-126-960-11	ELECT 1MF	20% 50V	C093	1-126-964-11	ELECT 10MF	20% 50V
C030	1-164-004-11	CERAMIC CHIP 0.1MF	10% 25V	C096	1-164-004-11	CERAMIC CHIP 0.1MF	10% 25V
C031	1-164-232-11	CERAMIC CHIP 0.01MF	10% 50V	C097	1-126-967-11	ELECT 47MF	20% 50V
C032	1-164-232-11	CERAMIC CHIP 0.01MF	10% 50V	C099	1-164-232-11	CERAMIC CHIP 0.01MF	10% 50V
C033	1-163-001-11	CERAMIC CHIP 220PF	10% 50V	C501	1-107-909-11	ELECT 47MF	20% 50V
C034	1-164-232-11	CERAMIC CHIP 0.01MF	10% 50V	C502	1-163-259-91	CERAMIC CHIP 220PF	5% 50V
C035	1-163-121-00	CERAMIC CHIP 150PF	5% 50V	C503	1-136-169-00	FILM 0.22MF	5% 50V
C036	1-164-004-11	CERAMIC CHIP 0.1MF	10% 25V	C504	1-107-364-11	MYLAR 0.01MF	10% 200V
C037	1-126-934-11	ELECT 220MF	20% 16V	C505	1-163-251-11	CERAMIC CHIP 100PF	5% 50V
C038	1-164-004-11	CERAMIC CHIP 0.1MF	10% 25V	C506	1-136-169-00	FILM 0.22MF	5% 50V
C039	1-126-964-11	ELECT 10MF	20% 50V	C507	1-136-173-00	FILM 0.47MF	5% 50V
C040	1-126-963-11	ELECT 4.7MF	20% 50V	C508	1-163-037-11	CERAMIC CHIP 0.022MF	10% 50V
C041	1-126-961-11	ELECT 2.2MF	20% 50V	C509	1-126-941-11	ELECT 470MF	20% 25V
C042	1-126-967-11	ELECT 47MF	20% 50V	C510	1-137-368-11	FILM 0.0047MF	5% 50V
C043	1-126-967-11	ELECT 47MF	20% 50V	C511	1-110-641-51	ELECT 33MF	20% 200V
C044	1-126-967-11	ELECT 47MF	20% 50V	C512	1-107-889-11	ELECT 220MF	20% 25V
C045	1-163-275-11	CERAMIC CHIP 0.001MF	5% 50V	C513	1-163-017-00	CERAMIC CHIP 0.0047MF	10% 50V
C046	1-164-004-11	CERAMIC CHIP 0.1MF	10% 25V	C514	1-164-232-11	CERAMIC CHIP 0.01MF	10% 50V
C047	1-126-934-11	ELECT 220MF	20% 16V	C515	1-107-889-11	ELECT 220MF	20% 25V
C048	1-164-695-11	CERAMIC CHIP 0.0022MF	5% 50V	C516	1-137-399-11	FILM 0.1MF	5% 50V
C049	1-163-137-00	CERAMIC CHIP 680PF	5% 50V	C517	1-115-350-51	CERAMIC 0.0047MF	2KV
C050	1-163-809-11	CERAMIC CHIP 0.047MF	10% 25V	C518	1-117-413-11	FILM 6000PF	3% 1.8KV
C051	1-126-960-11	ELECT 1MF	20% 50V	C519	1-162-558-11	CERAMIC 100PF	10% 2KV
C052	1-163-809-11	CERAMIC CHIP 0.047MF	10% 25V	C520	1-117-948-91	FILM 1500PF	5% 630V
C054	1-126-963-11	ELECT 4.7MF	20% 50V	C521	1-162-815-11	CERAMIC 47PF	5% 500V
C055	1-126-963-11	ELECT 4.7MF	20% 50V	C522	1-162-558-11	CERAMIC 100PF	10% 2KV
C056	1-163-809-11	CERAMIC CHIP 0.047MF	10% 25V	C523	1-137-370-11	FILM 0.01MF	5% 50V
C057	1-126-967-11	ELECT 47MF	20% 50V	C524	1-113-694-11	FILM 0.056MF	5% 400V
C058	1-126-934-11	ELECT 220MF	20% 16V	C525	1-107-846-11	FILM 0.1MF	5% 200V
C059	1-164-232-11	CERAMIC CHIP 0.01MF	10% 50V	C526	1-115-514-11	FILM 0.22MF	5% 200V
C060	1-126-964-11	ELECT 10MF	20% 50V	C527	1-117-451-11	FILM 0.43MF	5% 250V
C061	1-164-232-11	CERAMIC CHIP 0.01MF	10% 50V	C528	1-117-947-21	FILM 0.89MF	5% 250V
C062	1-137-399-11	FILM 0.1MF	5% 50V	C529	1-119-872-91	ELECT 1MF	20% 200V



REF.NO.	PART NO.	DESCRIPTION	REMARK	REF.NO.	PART NO.	DESCRIPTION	REMARK
C530	1-164-232-11	CERAMIC CHIP 0.01MF	10% 50V	C909	1-106-355-12	MYLAR 0.0033MF	10% 200V
C531	1-164-232-11	CERAMIC CHIP 0.01MF	10% 50V	C910	1-164-232-11	CERAMIC CHIP 0.01MF	10% 50V
C532	1-164-232-11	CERAMIC CHIP 0.01MF	10% 50V	C911	1-163-275-11	CERAMIC CHIP 0.001MF	5% 50V
C533	1-164-232-11	CERAMIC CHIP 0.01MF	10% 50V	C912	1-163-145-00	CERAMIC CHIP 0.0015MF	5% 50V
C534	1-164-232-11	CERAMIC CHIP 0.01MF	10% 50V	C913	1-164-004-11	CERAMIC CHIP 0.1MF	10% 25V
C535	1-164-232-11	CERAMIC CHIP 0.01MF	10% 50V	C914	1-163-275-11	CERAMIC CHIP 0.001MF	5% 50V
C536	1-107-909-11	ELECT 47MF	20% 50V	C915	1-164-232-11	CERAMIC CHIP 0.01MF	10% 50V
C537	1-113-696-11	FILM 1.4MF	5% 400V	C916	1-117-626-31	FILM 2000PF	3% 1.2KV
C538	1-136-757-11	FILM 0.33MF	5% 400V	C917	1-107-889-11	ELECT 220MF	20% 25V
C539	1-107-949-11	ELECT 2.2MF	20% 200V	C918	1-164-004-11	CERAMIC CHIP 0.1MF	10% 25V
C540	1-106-343-00	MYLAR 0.001MF	10% 200V	C919	1-164-232-11	CERAMIC CHIP 0.01MF	10% 50V
C541	1-163-243-11	CERAMIC CHIP 47PF	5% 50V	C921	1-163-243-11	CERAMIC CHIP 47PF	5% 50V
C542	1-163-243-11	CERAMIC CHIP 47PF	5% 50V	C922	1-117-665-11	FILM 0.33MF	5% 200V
C544	1-137-368-11	FILM 0.0047MF	5% 50V	C923	1-106-359-00	MYLAR 0.0047MF	10% 100V
C545	1-163-007-11	CERAMIC CHIP 680PF	10% 50V	C924	1-106-220-00	MYLAR 0.1MF	10% 100V
C547	1-126-967-11	ELECT 47MF	20% 50V	C925	1-137-372-11	FILM 0.022MF	5% 50V
C549	1-163-009-11	CERAMIC CHIP 0.001MF	10% 50V	C926	1-106-228-00	MYLAR 0.22MF	10% 100V
C551	1-163-009-11	CERAMIC CHIP 0.001MF	10% 50V	C927	1-107-903-11	ELECT 2.2MF	20% 50V
C553	1-126-963-11	ELECT 4.7MF	20% 50V	C928	1-164-232-11	CERAMIC CHIP 0.01MF	10% 50V
C554	1-164-004-11	CERAMIC CHIP 0.1MF	10% 25V	C929	1-107-889-11	ELECT 220MF	20% 25V
C555	1-163-037-11	CERAMIC CHIP 0.022MF	10% 50V	C930	1-164-232-11	CERAMIC CHIP 0.01MF	10% 50V
C556	1-163-009-11	CERAMIC CHIP 0.001MF	10% 50V	C931	1-164-232-11	CERAMIC CHIP 0.01MF	10% 50V
C559	1-162-134-11	CERAMIC 470PF	10% 2KV	C1001	1-164-232-11	CERAMIC CHIP 0.01MF	10% 50V
C561	1-136-173-00	FILM 0.47MF	5% 50V	C1002	1-164-232-11	CERAMIC CHIP 0.01MF	10% 50V
C562	1-163-017-00	CERAMIC CHIP 0.0047MF	10% 50V	C1003	1-126-960-11	ELECT 1MF	20% 50V
C590	1-164-232-11	CERAMIC CHIP 0.01MF	10% 50V			<CONNECTOR>	
C591	1-126-967-11	ELECT 47MF	20% 50V	CN501*	1-564-511-11	PLUG, CONNECTOR 8P	
C701	1-126-967-11	ELECT 47MF	20% 50V	CN502*	1-564-514-11	PLUG, CONNECTOR 11P	
C702	1-137-399-11	FILM 0.1MF	5% 50V	CN503*	1-564-510-11	PLUG, CONNECTOR 7P	
C703	1-163-003-11	CERAMIC CHIP 330PF	10% 50V	CN504*	1-564-508-11	PLUG, CONNECTOR 5P	
C704	1-164-161-11	CERAMIC CHIP 0.0022MF	10% 50V	CN505*	1-508-879-11	BASE POST	
C705	1-126-942-61	ELECT 1000MF	20% 25V	CN506*	1-564-511-11	PLUG, CONNECTOR 8P	
C706	1-164-232-11	CERAMIC CHIP 0.01MF	10% 50V	CN507	1-764-101-11	PIN, CONNECTOR (PC BOARD) 2P	
C707	1-164-232-11	CERAMIC CHIP 0.01MF	10% 50V	CN508*	1-774-513-11	PIN, CONNECTOR (PC BOARD) 9P	
C709	1-137-399-11	FILM 0.1MF	5% 50V	CN509*	1-564-507-11	PLUG, CONNECTOR 4P	
C710	1-163-019-00	CERAMIC CHIP 0.0068MF	10% 50V	CN511*	1-564-514-11	PLUG, CONNECTOR 11P	
C711	1-107-894-11	ELECT 220MF	20% 35V	CN901*	1-564-508-11	PLUG, CONNECTOR 5P	
C712	1-106-228-00	MYLAR 0.22MF	10% 100V			<DIODE>	
C713	1-126-942-61	ELECT 1000MF	20% 25V	D004	8-719-800-76	DIODE 1SS226	
C714	1-126-967-11	ELECT 47MF	20% 50V	D007	8-719-976-99	ZENER DIODE DTZ5.1B	
C715	1-128-562-11	ELECT 47MF	20% 100V	D008	8-719-976-99	ZENER DIODE DTZ5.1B	
C717	1-128-560-11	ELECT 22MF	20% 100V	D009	8-719-976-99	ZENER DIODE DTZ5.1B	
C729	1-162-134-11	CERAMIC 470PF	10% 2KV	D010	8-719-976-99	ZENER DIODE DTZ5.1B	
C735	1-137-399-11	FILM 0.1MF	5% 50V	D012	8-719-976-99	ZENER DIODE DTZ5.1B	
C746	1-163-009-11	CERAMIC CHIP 0.001MF	10% 50V	D013	8-719-976-96	ZENER DIODE DTZ4.7C	
C747	1-164-232-11	CERAMIC CHIP 0.01MF	10% 50V	D015	8-719-800-76	DIODE 1SS226	
C750	1-126-964-11	ELECT 10MF	20% 50V	D016	8-719-800-76	DIODE 1SS226	
C901	1-107-909-11	ELECT 47MF	20% 50V	D019	8-719-800-76	DIODE 1SS226	
C902	1-163-809-11	CERAMIC CHIP 0.047MF	10% 25V	D020	8-719-800-76	DIODE 1SS226	
C903	1-163-259-91	CERAMIC CHIP 220PF	5% 50V	D021	8-719-976-99	ZENER DIODE DTZ5.1B	
C904	1-107-364-11	MYLAR 0.01MF	10% 200V	D022	8-719-801-78	DIODE 1SS184	
C905	1-104-653-11	ELECT 220MF	20% 16V				
C906	1-106-220-00	MYLAR 0.1MF	10% 100V				
C907	1-110-641-51	ELECT 33MF	20% 200V				
C908	1-136-169-00	FILM 0.22MF	5% 50V				

The components identified by shading
and mark \triangle are critical for safety.
Replace only with part number specified.

Les composants identifiés par un tramé
et une marque \triangle sont critiques pour la
sécurité. Ne les remplacer que par une
pièce portant le numéro spécifié.



REF.NO.	PART NO.	DESCRIPTION	REMARK	REF.NO.	PART NO.	DESCRIPTION	REMARK
D023	8-719-976-99	ZENER DIODE DTZ5.1B				<FERRITE BEAD>	
D024	8-719-801-78	DIODE 1SS184					
D025	8-719-056-84	ZENER DIODE UDZ-TE-17-7.5B		FB501	1-410-397-21	FERRITE	1.1UH
D026	8-719-800-76	DIODE 1SS226		FB502	1-410-397-21	FERRITE	1.1UH
D027	8-719-800-76	DIODE 1SS226		FB901	1-410-397-21	FERRITE	1.1UH
D028	8-719-800-76	DIODE 1SS226		FB902	1-410-397-21	FERRITE	1.1UH
D029	8-719-800-76	DIODE 1SS226					
D050	8-719-404-49	DIODE MA111				<IC>	
D501	8-719-977-40	ZENER DIODE DTZ13B		IC001	8-759-496-17	IC MB90553PF-G-106-BND	
D502	8-719-063-89	DIODE YG911S3R		IC002	8-759-442-20	IC 24LC21A/SN	
D503	8-719-404-49	DIODE MA111		IC003	8-759-168-20	IC TA78L09S	
D504	8-719-984-73	DIODE SB560		IC004	8-759-454-79	IC 24LC16BT/SN	
D506	8-719-911-19	DIODE 1SS119-25		IC005	8-759-162-80	IC MM1170BFB	
D507	8-719-911-19	DIODE 1SS119-25		IC006	8-759-231-53	IC TA7805S	
D508	8-719-109-85	ZENER DIODE RD5.1ESB2		IC007	8-752-078-46	IC CXA2043Q	
D509	8-719-911-19	DIODE 1SS119-25		IC008	8-759-701-59	IC NJM78M09FA	
D510	8-719-951-30	DIODE ERA91-02		IC009	8-759-082-57	IC TC7W04FU	
D511	8-719-911-19	DIODE 1SS119-25		IC010	8-752-083-83	IC CXA2044M-T6	
D512	8-719-031-34	DIODE RGP02-20EG23		IC012	8-759-442-20	IC 24LC21A/SN	
D513	8-719-404-49	DIODE MA111		IC013	8-759-233-66	IC TC74HC704AF	
D514	8-719-109-93	ZENER DIODE RD6.2ESB2		IC501	8-749-011-63	IC IRSY5305	
D516	8-719-105-99	ZENER DIODE RD6.2M-B1		IC502	8-759-803-42	IC LA6500-FA	
D518	8-719-404-49	DIODE MA111		IC505	8-759-100-96	IC UPC4558G2	
D519	8-719-061-21	DIODE FMQ-G5FMS		IC701	8-759-822-38	IC LA6510	
D590	8-719-977-69	ZENER DIODE DTZ24B		IC702	8-759-444-82	IC LA7841L	
D701	8-719-976-99	ZENER DIODE DTZ5.1B		IC703	8-759-100-96	IC UPC4558G2	
D702	8-719-404-49	DIODE MA111		IC901 \triangle	8-759-467-70	IC BA9756FS-E2	
D703	8-719-404-49	DIODE MA111					
D704	8-719-404-49	DIODE MA111				<COIL>	
D705	8-719-404-49	DIODE MA111		L001	1-406-665-11	COIL, CHOKE	100UH
D706	8-719-976-99	ZENER DIODE DTZ5.1B		L002	1-406-665-11	COIL, CHOKE	100UH
D709	8-719-979-85	DIODE EGP20G		L003	1-412-537-31	INDUCTOR	100UH
D713	8-719-911-19	DIODE 1SS119-25		L004	1-412-537-31	INDUCTOR	100UH
D714	8-719-911-19	DIODE 1SS119-25		L006	1-410-482-31	INDUCTOR	100UH
D715	8-719-911-19	DIODE 1SS119-25		L007	1-412-537-31	INDUCTOR	100UH
D718	8-719-976-99	ZENER DIODE DTZ5.1B		L008	1-412-537-31	INDUCTOR	100UH
D720	8-719-028-72	DIODE RGP02-17EL-6433		L501	1-412-537-31	INDUCTOR	100UH
D721	8-719-028-72	DIODE RGP02-17EL-6433		L502	1-406-671-11	COIL, CHOKE	1.0MMH
D901	8-719-404-49	DIODE MA111		L503	1-411-585-11	COIL, HORIZONTAL LINEARITY	
D902	8-719-404-49	DIODE MA111		L504	1-411-584-11	COIL, HORIZONTAL LINEARITY	
D903	8-719-911-19	DIODE 1SS119-25		L505	1-414-493-41	INDUCTOR	4.7MMH
D904	8-719-404-49	DIODE MA111		L507	1-406-673-21	COIL, CHOKE	2.2MMH
D905	8-719-404-49	DIODE MA111		L701	1-412-537-31	INDUCTOR	100UH
D906	8-719-404-49	DIODE MA111		L702	1-412-522-31	INDUCTOR	5.6UH
D907	8-719-158-49	ZENER DIODE RD12SB2		L901	1-412-537-31	INDUCTOR	100UH
D908	8-719-158-49	ZENER DIODE RD12SB2		L902	1-406-660-41	COIL, CHOKE	15UH
D909	8-719-977-40	ZENER DIODE DTZ13B		L903	1-412-537-31	INDUCTOR	100UH
D910	8-719-063-89	DIODE YG911S3R		L904	1-410-482-31	INDUCTOR	100UH
D911	8-719-978-69	ZENER DIODE DTZ-TT11-16B				<IC LINK>	
D913	8-719-158-49	ZENER DIODE RD12SB2		PS501 \triangle	1-533-592-31	LINK, IC (1.6A/90V AC, 60V DC)	
D915	8-719-109-85	ZENER DIODE RD5.1ESB2		PS502 \triangle	1-532-984-91	LINK, IC (2A/90V)	
D916	8-719-939-79	DIODE GMA01-BT		PS503 \triangle	1-532-984-91	LINK, IC (2A/90V)	
D917	8-719-110-46	ZENER DIODE RD16ESB3		PS504 \triangle	1-532-984-91	LINK, IC (2A/90V)	
D919	8-719-911-19	DIODE 1SS119-25		PS701 \triangle	1-533-590-31	LINK, IC (1A/90V AC, 60V DC)	
D921	8-719-404-49	DIODE MA111					
D935	8-719-978-92	ZENER DIODE DTZ-TT11-30A					



Les composants identifiés par un tramé et une marque Δ sont critiques pour la sécurité. Ne les remplacer que par une pièce portant le numéro spécifié.

The components identified by shading and mark Δ are critical for safety. Replace only with part number specified.

REF.NO.	PART NO.	DESCRIPTION	REMARK	REF.NO.	PART NO.	DESCRIPTION	REMARK
		PS901 Δ 1-533-592-31 LINK, IC (1.6A/90V AC, 60V DC)		R020	1-216-049-91	RES,CHIP 1K	5% 1/10W
		<TRANSISTOR>		R023	1-216-025-91	RES,CHIP 100	5% 1/10W
		Q001 8-729-027-31 TRANSISTOR DTA124EKA-T146		R024	1-216-089-91	RES,CHIP 47K	5% 1/10W
		Q003 8-729-216-22 TRANSISTOR 2SA1162-G		R026	1-216-073-00	RES,CHIP 10K	5% 1/10W
		Q004 8-729-216-22 TRANSISTOR 2SA1162-G		R027	1-216-073-00	RES,CHIP 10K	5% 1/10W
		Q005 8-729-216-22 TRANSISTOR 2SA1162-G		R028	1-216-065-00	RES,CHIP 4.7K	5% 1/10W
		Q006 8-729-120-28 TRANSISTOR 2SC1623-L5L6		R029	1-216-089-91	RES,CHIP 47K	5% 1/10W
		Q007 8-729-120-28 TRANSISTOR 2SC1623-L5L6		R030	1-216-017-91	RES,CHIP 47	5% 1/10W
		Q501 8-729-120-28 TRANSISTOR 2SC1623-L5L6		R031	1-216-073-00	RES,CHIP 10K	5% 1/10W
		Q502 8-729-120-28 TRANSISTOR 2SC1623-L5L6		R032	1-216-675-11	METAL CHIP 10K	0.50%1/10W
		Q503 8-729-901-97 TRANSISTOR 2SA1036K-Q		R033	1-216-017-91	RES,CHIP 47	5% 1/10W
		Q504 8-729-120-28 TRANSISTOR 2SC1623-L5L6		R034	1-216-025-91	RES,CHIP 100	5% 1/10W
		Q505 8-729-216-22 TRANSISTOR 2SA1162-G		R035	1-216-049-91	RES,CHIP 1K	5% 1/10W
		Q506 8-729-820-73 TRANSISTOR 2SC3746		R036	1-216-025-91	RES,CHIP 100	5% 1/10W
		Q507 8-729-027-83 TRANSISTOR 2SJ307-CB14		R037	1-216-061-00	RES,CHIP 3.3K	5% 1/10W
		Q508 8-729-821-07 TRANSISTOR 2SC3997CA		R038	1-216-065-00	RES,CHIP 4.7K	5% 1/10W
		Q509 8-729-033-25 TRANSISTOR DTC114GKA		R039	1-216-049-91	RES,CHIP 1K	5% 1/10W
		Q510 8-729-120-28 TRANSISTOR 2SC1623-L5L6		R040	1-216-049-91	RES,CHIP 1K	5% 1/10W
		Q511 8-729-140-50 TRANSISTOR 2SC3209LK		R041	1-216-065-00	RES,CHIP 4.7K	5% 1/10W
		Q512 8-729-120-28 TRANSISTOR 2SC1623-L5L6		R042	1-216-089-91	RES,CHIP 47K	5% 1/10W
		Q517 8-729-216-22 TRANSISTOR 2SA1162-G		R043	1-216-065-00	RES,CHIP 4.7K	5% 1/10W
		Q522 8-729-027-96 TRANSISTOR IRLI530G		R044	1-216-105-91	RES,CHIP 220K	5% 1/10W
		Q590 8-729-033-26 TRANSISTOR DTA114GKAT146		R045	1-216-073-00	RES,CHIP 10K	5% 1/10W
		Q591 8-729-033-25 TRANSISTOR DTC114GKA		R046	1-216-675-11	METAL CHIP 10K	0.50%1/10W
		Q701 8-729-800-32 TRANSISTOR 2SC2362K-G		R047	1-216-073-00	RES,CHIP 10K	5% 1/10W
		Q703 8-729-178-43 TRANSISTOR 2SC2784-E		R048	1-216-049-91	RES,CHIP 1K	5% 1/10W
		Q704 8-729-207-82 TRANSISTOR 2SC3421-Y		R049	1-216-049-91	RES,CHIP 1K	5% 1/10W
		Q705 8-729-204-91 TRANSISTOR 2SA1049-GR		R050	1-216-025-91	RES,CHIP 100	5% 1/10W
		Q706 8-729-207-89 TRANSISTOR 2SA1358-Y		R051	1-216-679-11	METAL CHIP 15K	0.50%1/10W
		Q707 8-729-216-22 TRANSISTOR 2SA1162-G		R052	1-216-073-00	RES,CHIP 10K	5% 1/10W
		Q708 8-729-020-07 TRANSISTOR 2SC4686A(LBSONY)		R053	1-216-675-11	METAL CHIP 10K	0.50%1/10W
		Q901 8-729-120-28 TRANSISTOR 2SC1623-L5L6		R054	1-216-675-11	METAL CHIP 10K	0.50%1/10W
		Q902 8-729-216-22 TRANSISTOR 2SA1162-G		R055	1-216-089-91	RES,CHIP 47K	5% 1/10W
		Q904 8-729-120-28 TRANSISTOR 2SC1623-L5L6		R056	1-216-671-11	METAL CHIP 6.8K	0.50%1/10W
		Q905 8-729-901-97 TRANSISTOR 2SA1036K-Q		R057	1-216-679-11	METAL CHIP 15K	0.50%1/10W
		Q908 8-729-035-54 TRANSISTOR 2SJ449		R058	1-216-663-11	METAL CHIP 3.3K	0.50%1/10W
		Q909 8-729-041-58 TRANSISTOR 2SK2675		R059	1-216-065-00	RES,CHIP 4.7K	5% 1/10W
		<RESISTOR>		R060	1-216-049-91	RES,CHIP 1K	5% 1/10W
		R001 1-216-025-91 RES,CHIP 100 5% 1/10W		R061	1-216-065-00	RES,CHIP 4.7K	5% 1/10W
		R002 1-216-049-91 RES,CHIP 1K 5% 1/10W		R062	1-216-025-91	RES,CHIP 100	5% 1/10W
		R003 1-216-049-91 RES,CHIP 1K 5% 1/10W		R063	1-216-025-91	RES,CHIP 100	5% 1/10W
		R004 1-216-073-00 RES,CHIP 10K 5% 1/10W		R064	1-216-025-91	RES,CHIP 100	5% 1/10W
		R005 1-216-073-00 RES,CHIP 10K 5% 1/10W		R065	1-216-025-91	RES,CHIP 100	5% 1/10W
		R006 1-216-049-91 RES,CHIP 1K 5% 1/10W		R066	1-216-025-91	RES,CHIP 100	5% 1/10W
		R007 1-216-025-91 RES,CHIP 100 5% 1/10W		R067	1-216-025-91	RES,CHIP 100	5% 1/10W
		R008 1-216-089-91 RES,CHIP 47K 5% 1/10W		R068	1-216-025-91	RES,CHIP 100	5% 1/10W
		R009 1-216-025-91 RES,CHIP 100 5% 1/10W		R069	1-216-017-91	RES,CHIP 47	5% 1/10W
		R010 1-216-081-00 RES,CHIP 22K 5% 1/10W		R070	1-216-675-11	METAL CHIP 10K	0.50%1/10W
		R011 1-216-097-91 RES,CHIP 100K 5% 1/10W		R071	1-216-049-91	RES,CHIP 1K	5% 1/10W
		R012 1-216-025-91 RES,CHIP 100 5% 1/10W		R072	1-216-651-11	METAL CHIP 1K	0.50%1/10W
		R013 1-216-675-11 METAL CHIP 10K 0.50%1/10W		R073	1-216-295-91	SHORT 0	
		R017 1-216-049-91 RES,CHIP 1K 5% 1/10W		R074	1-216-675-11	METAL CHIP 10K	0.50%1/10W
		R018 1-216-049-91 RES,CHIP 1K 5% 1/10W		R075	1-216-295-91	SHORT 0	
				R077	1-216-049-91	RES,CHIP 1K	5% 1/10W
				R078	1-216-049-91	RES,CHIP 1K	5% 1/10W
				R079	1-216-017-91	RES,CHIP 47	5% 1/10W



REF.NO.	PART NO.	DESCRIPTION	REMARK	REF.NO.	PART NO.	DESCRIPTION	REMARK
R080	1-216-017-91	RES,CHIP	47 5% 1/10W	R542	1-215-863-11	METAL OXIDE	100 5% 1W F
R081	1-216-675-11	METAL CHIP	10K 0.50%1/10W	R543	1-216-655-11	METAL CHIP	1.5K 0.50%1/10W
R082	1-216-065-00	RES,CHIP	4.7K 5% 1/10W	R544	1-260-085-11	CARBON	68 5% 1/2W
R083	1-216-057-00	RES,CHIP	2.2K 5% 1/10W	R545	1-216-683-11	METAL CHIP	22K 0.50%1/10W
R084	1-216-025-91	RES,CHIP	100 5% 1/10W	R546	1-216-065-00	RES,CHIP	4.7K 5% 1/10W
R085	1-216-025-91	RES,CHIP	100 5% 1/10W	R547	1-216-663-11	METAL CHIP	3.3K 0.50%1/10W
R087	1-216-039-00	RES,CHIP	390 5% 1/10W	R548	1-215-445-00	METAL	10K 1% 1/4W
R088	1-216-057-00	RES,CHIP	2.2K 5% 1/10W	R549	1-216-675-11	METAL CHIP	10K 0.50%1/10W
R089	1-216-057-00	RES,CHIP	2.2K 5% 1/10W	R550	1-216-655-11	METAL CHIP	1.5K 0.50%1/10W
R090	1-216-057-00	RES,CHIP	2.2K 5% 1/10W	R551	1-216-659-11	METAL CHIP	2.2K 0.50%1/10W
R092	1-216-057-00	RES,CHIP	2.2K 5% 1/10W	R552	1-216-057-00	RES,CHIP	2.2K 5% 1/10W
R094	1-216-057-00	RES,CHIP	2.2K 5% 1/10W	R553	1-216-675-11	METAL CHIP	10K 0.50%1/10W
R096	1-216-295-91	SHORT	0	R554	1-216-689-11	METAL CHIP	39K 0.50%1/10W
R097	1-216-057-00	RES,CHIP	2.2K 5% 1/10W	R555	1-216-677-11	METAL CHIP	12K 0.50%1/10W
R098	1-216-025-91	RES,CHIP	100 5% 1/10W	R557	1-216-699-11	METAL CHIP	100K 0.50%1/10W
R501	1-216-065-00	RES,CHIP	4.7K 5% 1/10W	R558	1-216-683-11	METAL CHIP	22K 0.50%1/10W
R502	1-216-057-00	RES,CHIP	2.2K 5% 1/10W	R559	1-249-441-11	CARBON	100K 5% 1/4W
R503	1-216-041-00	RES,CHIP	470 5% 1/10W	R561	1-216-683-11	METAL CHIP	22K 0.50%1/10W
R504	1-216-057-00	RES,CHIP	2.2K 5% 1/10W	R562	1-249-401-11	CARBON	47 5% 1/4W F
R505	1-216-041-00	RES,CHIP	470 5% 1/10W	R563	1-216-666-11	METAL CHIP	4.3K 0.50%1/10W
R506	1-249-397-11	CARBON	22 5% 1/4W F	R564	1-216-699-11	METAL CHIP	100K 0.50%1/10W
R507	1-216-065-00	RES,CHIP	4.7K 5% 1/10W	R565	1-216-675-11	METAL CHIP	10K 0.50%1/10W
R508	1-216-025-91	RES,CHIP	100 5% 1/10W	R566	1-215-884-11	METAL OXIDE	47 5% 2W F
R509	1-216-057-00	RES,CHIP	2.2K 5% 1/10W	R571	1-216-381-11	METAL OXIDE	0.22 5% 3W F
R510	1-216-065-00	RES,CHIP	4.7K 5% 1/10W	R572	1-216-097-91	RES,CHIP	100K 5% 1/10W
R511	1-219-731-11	METAL	2.4 1% 10W	R573	1-216-097-91	RES,CHIP	100K 5% 1/10W
R512	1-216-627-11	METAL CHIP	100 0.50%1/10W	R574	1-216-097-91	RES,CHIP	100K 5% 1/10W
R513	1-215-860-11	METAL OXIDE	33 5% 1W F	R575	1-216-097-91	RES,CHIP	100K 5% 1/10W
R514	1-211-796-11	FUSIBLE	1 5% 1/2W F	R576	1-216-097-91	RES,CHIP	100K 5% 1/10W
R515	1-216-675-11	METAL CHIP	10K 0.50%1/10W	R577	1-216-057-00	RES,CHIP	2.2K 5% 1/10W
R516	1-247-815-91	CARBON	220 5% 1/4W	R578	1-216-025-91	RES,CHIP	100 5% 1/10W
R517	1-216-065-00	RES,CHIP	4.7K 5% 1/10W	R579	1-216-672-11	METAL CHIP	7.5K 0.50%1/10W
R518	1-216-097-91	RES,CHIP	100K 5% 1/10W	R580	1-216-073-00	RES,CHIP	10K 5% 1/10W
R519	1-216-393-00	METAL OXIDE	2.2 5% 3W F	R581	1-216-073-00	RES,CHIP	10K 5% 1/10W
R520	1-216-393-00	METAL OXIDE	2.2 5% 3W F	R582	1-216-073-00	RES,CHIP	10K 5% 1/10W
R521	1-249-413-11	CARBON	470 5% 1/4W F	R583	1-216-677-11	METAL CHIP	12K 0.50%1/10W
R522	1-216-423-11	METAL OXIDE	27 5% 1W F	R584	1-216-081-00	RES,CHIP	22K 5% 1/10W
R523	1-249-425-11	CARBON	4.7K 5% 1/4W F	R585	1-216-081-00	RES,CHIP	22K 5% 1/10W
R524	1-215-869-11	METAL OXIDE	1K 5% 1W F	R590	1-216-681-11	METAL CHIP	18K 0.50%1/10W
R525	1-216-681-11	METAL CHIP	18K 0.50%1/10W	R591	1-216-681-11	METAL CHIP	18K 0.50%1/10W
R526	1-214-840-00	METAL	100 1% 1/2W	R592	1-215-481-00	METAL	330K 1% 1/4W
R527	1-214-840-00	METAL	100 1% 1/2W	R593	1-215-459-00	METAL	39K 1% 1/4W
R528	1-214-840-00	METAL	100 1% 1/2W	R594	1-249-437-11	CARBON	47K 5% 1/4W
R529	1-260-311-11	CARBON	39 5% 1/2W	R595	1-249-437-11	CARBON	47K 5% 1/4W
R530	1-249-437-11	CARBON	47K 5% 1/4W	R596	1-216-683-11	METAL CHIP	22K 0.50%1/10W
R531	1-249-437-11	CARBON	47K 5% 1/4W	R597	1-216-049-91	RES,CHIP	1K 5% 1/10W
R532	1-249-437-11	CARBON	47K 5% 1/4W	R598	1-216-041-00	RES,CHIP	470 5% 1/10W
R533	1-249-437-11	CARBON	47K 5% 1/4W	R599	1-216-673-11	METAL CHIP	8.2K 0.50%1/10W
R534	1-249-437-11	CARBON	47K 5% 1/4W	R701	1-249-383-11	CARBON	1.5 5% 1/4W F
R535	1-216-049-91	RES,CHIP	1K 5% 1/10W	R702	1-216-057-00	RES,CHIP	2.2K 5% 1/10W
R536	1-216-049-91	RES,CHIP	1K 5% 1/10W	R703	1-216-085-00	RES,CHIP	33K 5% 1/10W
R537	1-216-049-91	RES,CHIP	1K 5% 1/10W	R704	1-249-383-11	CARBON	1.5 5% 1/4W F
R538	1-216-049-91	RES,CHIP	1K 5% 1/10W	R705	1-249-385-11	CARBON	2.2 5% 1/4W
R539	1-216-049-91	RES,CHIP	1K 5% 1/10W	R706	1-216-093-00	RES,CHIP	68K 5% 1/10W
R540	1-216-073-00	RES,CHIP	10K 5% 1/10W	R707	1-249-421-11	CARBON	2.2K 5% 1/4W
R541	1-260-316-51	CARBON	100 5% 1/2W	R708	1-216-075-00	RES,CHIP	12K 5% 1/10W



Les composants identifiés per un tramé et une marque Δ sont critiques pour la sécurité. Ne les remplacer que par une pièce portant le numéro spécifié.

The components identified by shading and mark Δ are critical for safety. Replace only with part number specified.

REF.NO.	PART NO.	DESCRIPTION	REMARK	REF.NO.	PART NO.	DESCRIPTION	REMARK
R709	1-216-473-11	METAL OXIDE 56	5% 3W F	R910	1-216-073-00	RES,CHIP 10K	5% 1/10W
R710	1-216-073-00	RES,CHIP 10K	5% 1/10W	R911	1-216-049-91	RES,CHIP 1K	5% 1/10W
R711	1-249-383-11	CARBON 1.5	5% 1/4W F	R912	1-218-772-11	METAL CHIP 680K	0.50%1/10W
R712	1-249-385-11	CARBON 2.2	5% 1/4W	R913	1-219-748-11	CARBON 4.7K	5% 1/2W
R713	1-216-105-91	RES,CHIP 220K	5% 1/10W	R914	1-219-510-11	CARBON 470K	5% 1/2W
R714	1-216-081-00	RES,CHIP 22K	5% 1/10W	R915	1-249-437-11	CARBON 47K	5% 1/4W
R715	1-216-073-00	RES,CHIP 10K	5% 1/10W	R916	1-249-429-11	CARBON 10K	5% 1/4W
R716	1-216-073-00	RES,CHIP 10K	5% 1/10W	R917	1-216-073-00	RES,CHIP 10K	5% 1/10W
R717	1-216-085-00	RES,CHIP 33K	5% 1/10W	R918	1-216-097-91	RES,CHIP 100K	5% 1/10W
R718	1-216-450-00	METAL OXIDE 82	5% 2W F	R919	1-216-025-91	RES,CHIP 100	5% 1/10W
R719	1-249-383-11	CARBON 1.5	5% 1/4W F	R920	1-249-401-11	CARBON 47	5% 1/4W F
R720	1-260-292-11	CARBON 1	5% 1/2W	R921	1-216-668-11	METAL CHIP 5.1K	0.50%1/10W
R721	1-216-667-11	METAL CHIP 4.7K	0.50%1/10W	R922	1-216-041-00	RES,CHIP 470	5% 1/10W
R722	1-216-691-11	METAL CHIP 47K	0.50%1/10W	R923	1-216-675-11	METAL CHIP 10K	0.50%1/10W
R723	1-216-663-11	METAL CHIP 3.3K	0.50%1/10W	R924	1-249-397-11	CARBON 22	5% 1/4W F
R724	1-214-798-21	METAL 1.8	1% 1/2W	R925	1-216-653-11	METAL CHIP 1.2K	0.50%1/10W
R725	1-214-798-21	METAL 1.8	1% 1/2W	R926	1-216-653-11	METAL CHIP 1.2K	0.50%1/10W
R726	1-216-675-11	METAL CHIP 10K	0.50%1/10W	R927	1-216-073-00	RES,CHIP 10K	5% 1/10W
R727	1-260-292-11	CARBON 1	5% 1/2W	R929	1-216-033-00	RES,CHIP 220	5% 1/10W
R728	1-249-381-11	CARBON 1	5% 1/4W F	R930	1-216-033-00	RES,CHIP 220	5% 1/10W
R729	1-215-865-11	METAL OXIDE 220	5% 1W F	R933	1-216-683-11	METAL CHIP 22K	0.50%1/10W
R730	1-219-746-11	CARBON 1K	5% 1/2W	R934	1-216-667-11	METAL CHIP 4.7K	0.50%1/10W
R731	1-216-073-00	RES,CHIP 10K	5% 1/10W	R937	1-219-727-11	METAL 68	5% 10W
R732	1-216-073-00	RES,CHIP 10K	5% 1/10W	R940	1-249-393-11	CARBON 10	5% 1/4W F
R733	1-219-746-11	CARBON 1K	5% 1/2W	R980	1-216-049-91	RES,CHIP 1K	5% 1/10W
R734	1-215-881-11	METAL OXIDE 15	5% 2W F	R981	1-216-025-91	RES,CHIP 100	5% 1/10W
R737	1-249-377-11	CARBON 0.47	5% 1/4W F	R1001	1-216-073-00	RES,CHIP 10K	5% 1/10W
R738	1-249-377-11	CARBON 0.47	5% 1/4W F	R1002	1-216-025-91	RES,CHIP 100	5% 1/10W
R739	1-249-413-11	CARBON 470	5% 1/4W F	R1008	1-216-049-91	RES,CHIP 1K	5% 1/10W
R741	1-249-430-11	CARBON 12K	5% 1/4W	R1009	1-216-025-91	RES,CHIP 100	5% 1/10W
R742	1-249-419-11	CARBON 1.5K	5% 1/4W	R1010	1-249-389-11	CARBON 4.7	5% 1/4W F
R743	1-216-049-91	RES,CHIP 1K	5% 1/10W	R1011	1-216-073-00	RES,CHIP 10K	5% 1/10W
R748	1-216-683-11	METAL CHIP 22K	0.50%1/10W	R1012	1-216-049-91	RES,CHIP 1K	5% 1/10W
R749	1-216-025-91	RES,CHIP 100	5% 1/10W	R1015	1-249-389-11	CARBON 4.7	5% 1/4W F
R750	1-216-057-00	RES,CHIP 2.2K	5% 1/10W	R1016	1-216-065-00	RES,CHIP 4.7K	5% 1/10W
R751	1-216-065-00	RES,CHIP 4.7K	5% 1/10W	<RELAY>			
R752	1-216-083-00	RES,CHIP 27K	5% 1/10W	RY501	1-755-137-11	RELAY	
R753	1-219-720-11	METAL 10M	5% 1W	<SPARK GAP>			
R754	1-219-510-11	CARBON 470K	5% 1/2W	SG701	1-519-422-11	GAP, SPARK	
R755	1-219-510-11	CARBON 470K	5% 1/2W	SG702	1-519-422-11	GAP, SPARK	
R759	1-218-754-11	METAL CHIP 120K	0.50%1/10W	SG901	1-517-499-21	GAP, SPARK	
R776	1-216-049-91	RES,CHIP 1K	5% 1/10W	<TRANSFORMER>			
R777	1-216-681-11	METAL CHIP 18K	0.50%1/10W	T501	1-429-303-21	TRANSFORMER, FERRITE (HDT)	
R778	1-216-667-11	METAL CHIP 4.7K	0.50%1/10W	T502	1-416-401-11	COIL, CHOKE 5MMH	
R779	1-216-049-91	RES,CHIP 1K	5% 1/10W	T503	1-431-413-11	TRANSFORMER, FERRITE (HST)	
R784	1-216-067-00	RES,CHIP 5.6K	5% 1/10W	T504	1-416-257-11	COIL, CHOKE (HCC) 2.0MH	
R900	1-216-399-00	METAL OXIDE 6.8	5% 3W F	T701	1-431-414-11	TRANSFORMER, FERRITE (DFT)	
R901	1-216-057-00	RES,CHIP 2.2K	5% 1/10W	T901	1-411-592-21	COIL, CHOKE 500UH	
R902	1-216-065-00	RES,CHIP 4.7K	5% 1/10W	T902	Δ X-4034-920-1	TRANSFORMER ASSY, FLYBACK	
R903	1-216-073-00	RES,CHIP 10K	5% 1/10W				(NX-4141//J1D4)
R904	1-216-057-00	RES,CHIP 2.2K	5% 1/10W				
R905	1-216-025-91	RES,CHIP 100	5% 1/10W				
R906	1-216-065-00	RES,CHIP 4.7K	5% 1/10W				
R907	1-216-025-91	RES,CHIP 100	5% 1/10W				
R908	1-216-693-11	METAL CHIP 56K	0.50%1/10W				
R909	1-216-689-11	METAL CHIP 39K	0.50%1/10W				



REF.NO.	PART NO.	DESCRIPTION	REMARK	REF.NO.	PART NO.	DESCRIPTION	REMARK
		<THERMISTOR>				<SWITCH>	
TH501	1-807-796-11	THERMISTOR		S802	1-692-431-21	SWITCH, TACTILE (CONT+)	
		<CRYSTAL>		S803	1-692-431-21	SWITCH, TACTILE (CONT-)	
X001	1-567-781-61	VIBRATOR, CRYSTAL		S804	1-692-431-21	SWITCH, TACTILE (MENU)	
				S805	1-692-431-21	SWITCH, TACTILE (BRT+)	
				S806	1-692-431-21	SWITCH, TACTILE (BRT-)	
				S808	1-692-431-21	SWITCH, TACTILE (ASC)	
				S810	1-692-431-21	SWITCH, TACTILE (RESET)	
*****				*****			
		* 8-933-254-00 CONTROL BLOCK ASSY (H BOARD)				* 8-933-253-00 POWER SW ASSY (J BOARD)	
		*****				*****	
		* 4-049-002-01 HOLDER, LED (D810)					
		<CAPACITOR>				<CONNECTOR>	
C800	1-164-232-11	CERAMIC CHIP 0.01MF	10% 50V	CN891	1-691-960-11	PIN, CONNECTOR (PC BOARD) 3P	
C801	1-164-232-11	CERAMIC CHIP 0.01MF	10% 50V				
C804	1-164-232-11	CERAMIC CHIP 0.01MF	10% 50V			<SWITCH>	
C810	1-164-232-11	CERAMIC CHIP 0.01MF	10% 50V				
C811	1-126-022-11	ELECT 47MF	20% 25V	S891	1-571-433-21	SWITCH, PUSH (AC POWER)	
		<CONNECTOR>					
CN801*	1-779-683-21	PIN, CONNECTOR (PWB) 9P					
		<DIODE>					
D800	8-719-800-76	DIODE 1SS226					
D801	8-719-800-76	DIODE 1SS226					
D804	8-719-800-76	DIODE 1SS226					
D810	8-719-045-19	DIODE SPB-26MVWF					
		<TRANSISTOR>					
Q810	8-729-120-28	TRANSISTOR 2SC1623-L5L6					
Q811	8-729-120-28	TRANSISTOR 2SC1623-L5L6					
		<RESISTOR>					
R801	1-216-061-00	RES,CHIP	3.3K 5% 1/10W				
R802	1-216-037-00	RES,CHIP	330 5% 1/10W				
R803	1-216-037-00	RES,CHIP	330 5% 1/10W				
R804	1-216-041-00	RES,CHIP	470 5% 1/10W				
R805	1-216-041-00	RES,CHIP	470 5% 1/10W				
R806	1-216-045-00	RES,CHIP	680 5% 1/10W				
R807	1-216-049-91	RES,CHIP	1K 5% 1/10W				
R808	1-216-049-91	RES,CHIP	1K 5% 1/10W				
R809	1-216-057-00	RES,CHIP	2.2K 5% 1/10W				
R810	1-216-035-00	RES,CHIP	270 5% 1/10W				
R811	1-216-041-00	RES,CHIP	470 5% 1/10W				
R814	1-216-061-00	RES,CHIP	3.3K 5% 1/10W				
R820	1-216-049-91	RES,CHIP	1K 5% 1/10W				
R821	1-216-049-91	RES,CHIP	1K 5% 1/10W				