

DESCRIPTION

The SSF2300A uses advanced trench technology to provide excellent $R_{DS(ON)}$, low gate charge and operation with gate voltages as low as 2.5V. This device is suitable for use as a Battery protection or in other Switching application.

GENERAL FEATURES

- $V_{DS} = 20V, I_D = 4.5A$
 $R_{DS(ON)} < 50m\Omega @ V_{GS}=2.5V$
 $R_{DS(ON)} < 40m\Omega @ V_{GS}=4.5V$
- High Power and current handling capability
- Lead free product is acquired
- Surface Mount Package

Application

- Battery protection
- Load switch
- Power management

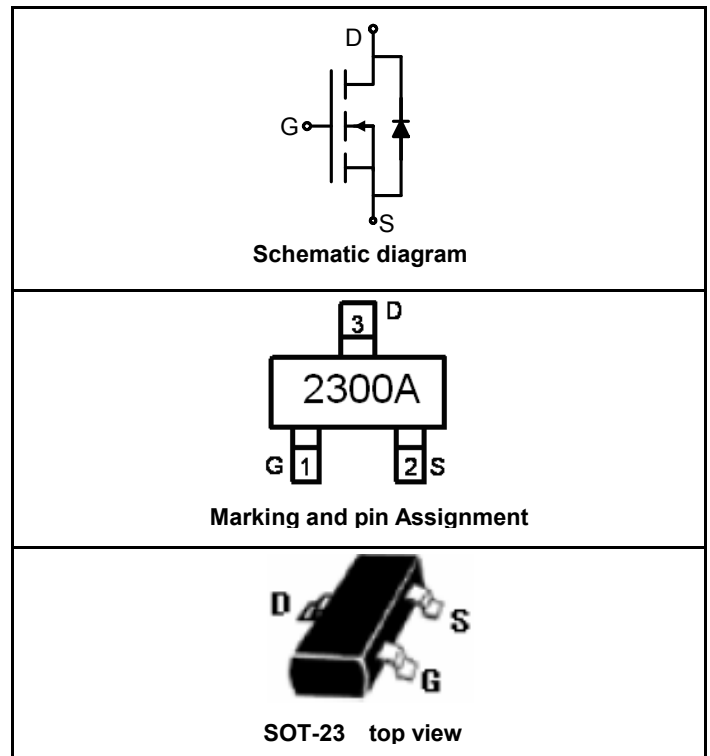

PACKAGE MARKING AND ORDERING INFORMATION

| Device Marking | Device | Device Package | Reel Size | Tape width | Quantity |
|----------------|----------|----------------|-----------|------------|------------|
| 2300A | SSF2300A | SOT-23 | Ø180mm | 8 mm | 3000 units |

ABSOLUTE MAXIMUM RATINGS(TA=25°C unless otherwise noted)

| Parameter | Symbol | Limit | Unit |
|---|----------------|------------|------|
| Drain-Source Voltage | V_{DS} | 20 | V |
| Gate-Source Voltage | V_{GS} | ±10 | V |
| Drain Current-Continuous@ Current-Pulsed (Note 1) | I_D | 4.5 | A |
| | I_{DM} | 16 | A |
| Maximum Power Dissipation | P_D | 1.2 | W |
| Operating Junction and Storage Temperature Range | T_J, T_{STG} | -55 To 150 | °C |

THERMAL CHARACTERISTICS

| | | | |
|---|-----------------|-----|------|
| Thermal Resistance,Junction-to-Ambient (Note 2) | $R_{\theta JA}$ | 140 | °C/W |
|---|-----------------|-----|------|

ELECTRICAL CHARACTERISTICS (TA=25°C unless otherwise noted)

| Parameter | Symbol | Condition | Min | Typ | Max | Unit |
|--------------------------------|------------|---------------------------|-----|-----|-----|------|
| OFF CHARACTERISTICS | | | | | | |
| Drain-Source Breakdown Voltage | BV_{DSS} | $V_{GS}=0V, I_D=250\mu A$ | 20 | | | V |



GDSSF2300A

| | | | | | | |
|---|--------------|--|-----|-----|-----------|------------|
| Zero Gate Voltage Drain Current | I_{DSS} | $V_{DS}=20V, V_{GS}=0V$ | | | 1 | μA |
| Gate-Body Leakage Current | I_{GSS} | $V_{GS}=\pm 10V, V_{DS}=0V$ | | | ± 100 | nA |
| ON CHARACTERISTICS (Note 3) | | | | | | |
| Gate Threshold Voltage | $V_{GS(th)}$ | $V_{DS}=V_{GS}, I_D=250\mu A$ | 0.5 | 0.7 | 1.5 | V |
| Drain-Source On-State Resistance | $R_{DS(ON)}$ | $V_{GS}=2.5V, I_D=4A$ | | 35 | 50 | m Ω |
| | | $V_{GS}=4.5V, I_D=4.5A$ | | 28 | 40 | m Ω |
| Forward Transconductance | g_{FS} | $V_{DS}=10V, I_D=4.5A$ | | 8 | | S |
| DYNAMIC CHARACTERISTICS (Note4) | | | | | | |
| Input Capacitance | C_{ISS} | $V_{DS}=10V, V_{GS}=0V,$ $F=1.0MHz$ | | 500 | | PF |
| Output Capacitance | C_{OSS} | | | 250 | | PF |
| Reverse Transfer Capacitance | C_{RSS} | | | 90 | | PF |
| SWITCHING CHARACTERISTICS (Note 4) | | | | | | |
| Turn-on Delay Time | $t_{d(on)}$ | $V_{DD}=10V, R_L = 2.8 \Omega$ $V_{GS}=4.5V, R_{GEN}=6\Omega,$ $I_D=3.6A,$ | | 7 | | nS |
| Turn-on Rise Time | t_r | | | 55 | | nS |
| Turn-Off Delay Time | $t_{d(off)}$ | | | 16 | | nS |
| Turn-Off Fall Time | t_f | | | 10 | | nS |
| Total Gate Charge | Q_g | $V_{DS}=10V, I_D=4.2A, V_{GS}=4.5V$ | | 10 | | nC |
| Gate-Source Charge | Q_{gs} | | | 2.3 | | nC |
| Gate-Drain Charge | Q_{gd} | | | 2.9 | | nC |
| DRAIN-SOURCE DIODE CHARACTERISTICS | | | | | | |
| Diode Forward Voltage (Note 3) | V_{SD} | $V_{GS}=0V, I_S=1.3A$ | | | 1.2 | V |

NOTES:

1. Repetitive Rating: Pulse width limited by maximum junction temperature.
2. Surface Mounted on FR4 Board, $t \leq 10$ sec.
3. Pulse Test: Pulse Width $\leq 300\mu s$, Duty Cycle $\leq 2\%$.
4. Guaranteed by design, not subject to production testing.

TYPICAL ELECTRICAL AND THERMAL CHARACTERISTICS

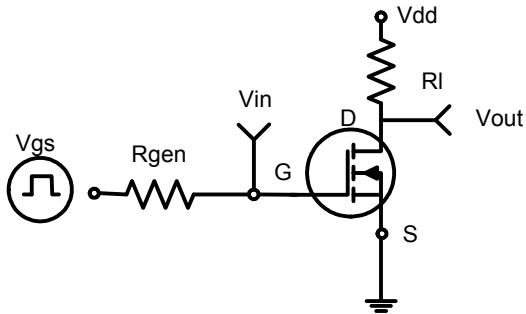

Figure 1: Switching Test Circuit

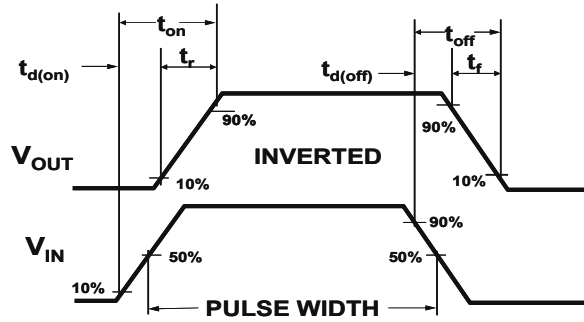

Figure 2: Switching Waveforms

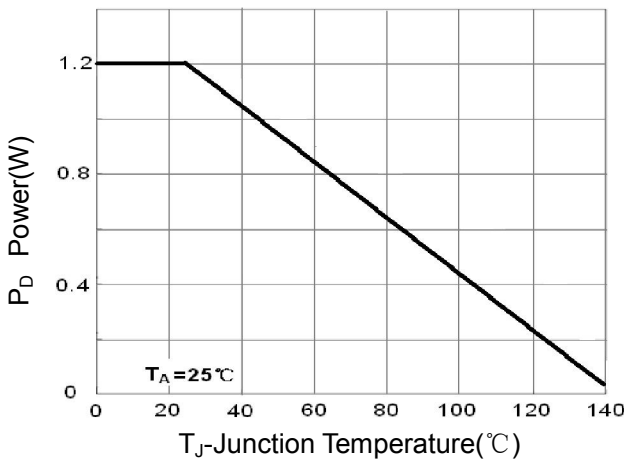

Figure 3 Power Dissipation

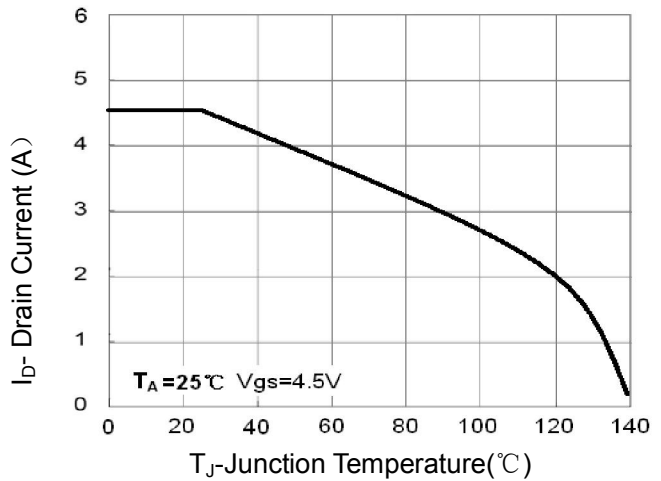

Figure 4 Drain Current

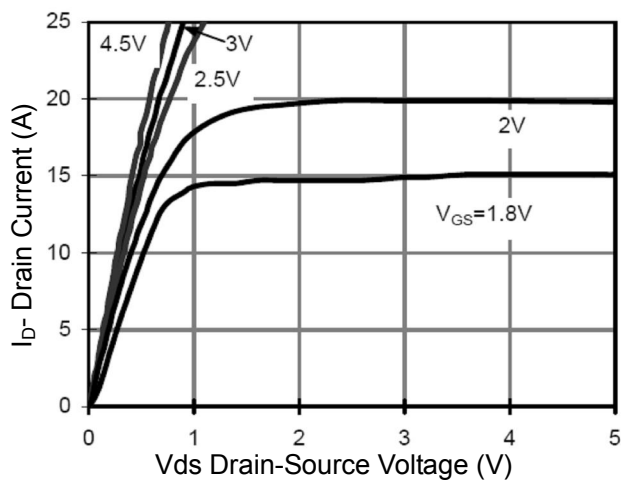

Figure 5 Output CHARACTERISTICS

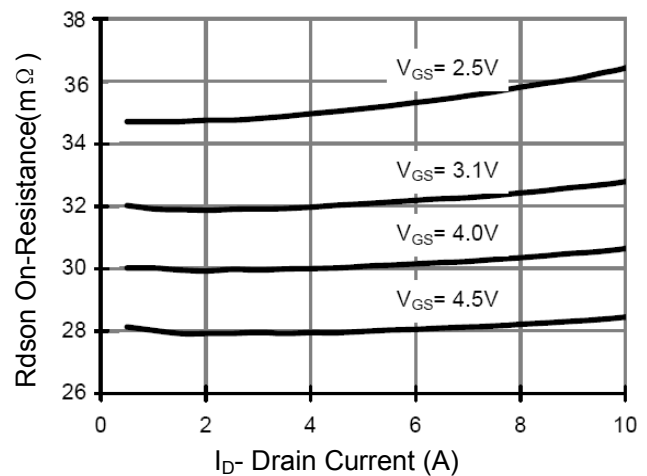

Figure 6 Drain-Source On-Resistance

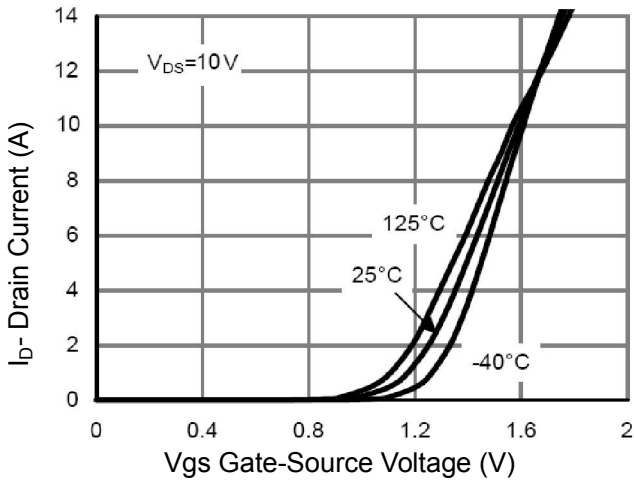

Figure 7 Transfer Characteristics

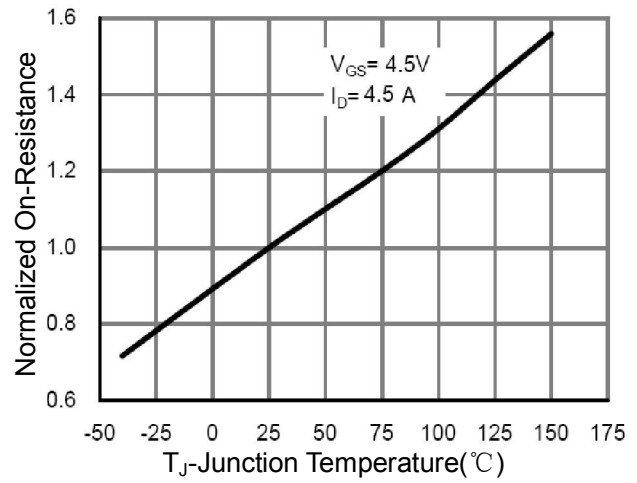

Figure 8 Drain-Source On-Resistance

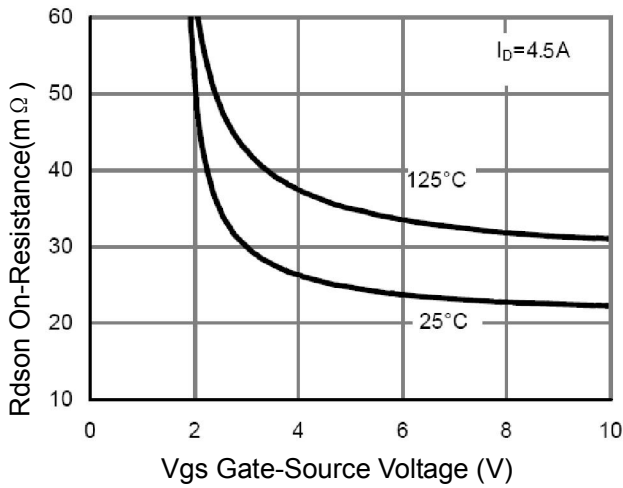

Figure 9 $R_{DS(on)}$ vs V_{GS}

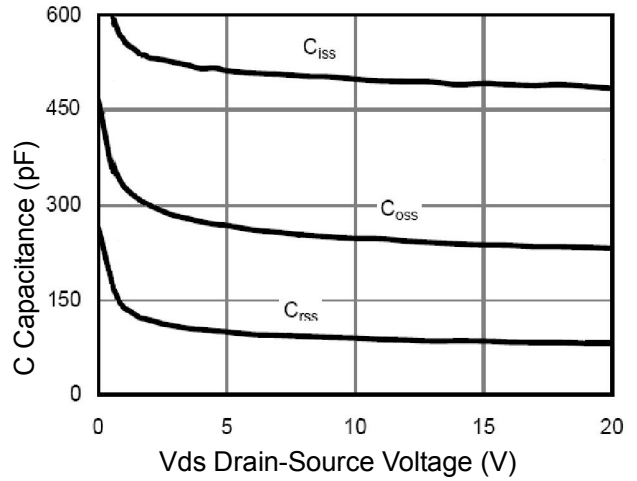

Figure 10 Capacitance vs V_{DS}

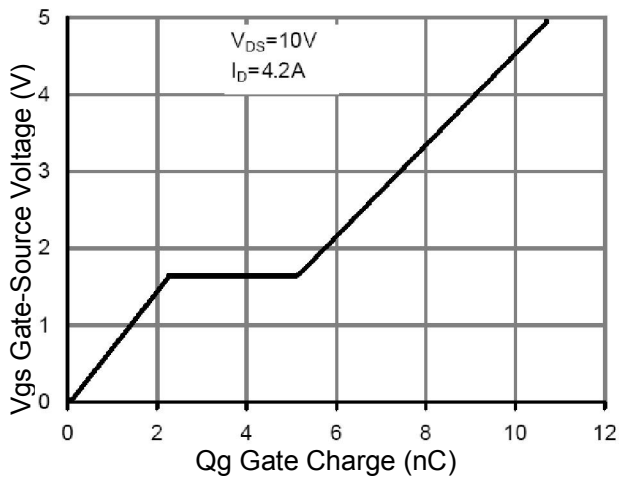

Figure 11 Gate Charge

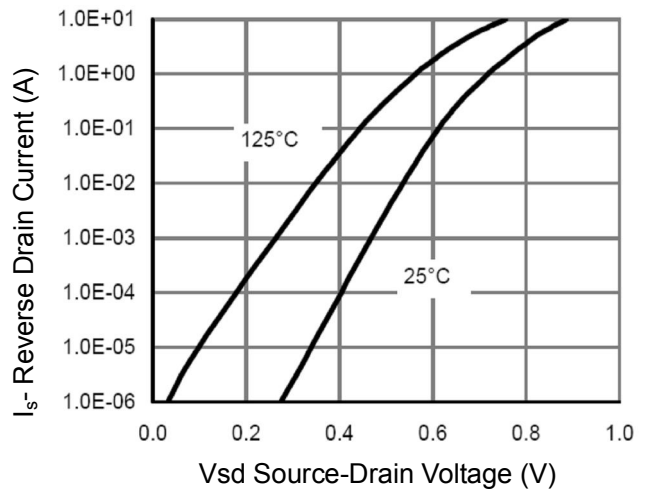

Figure 12 Source- Drain Diode Forward

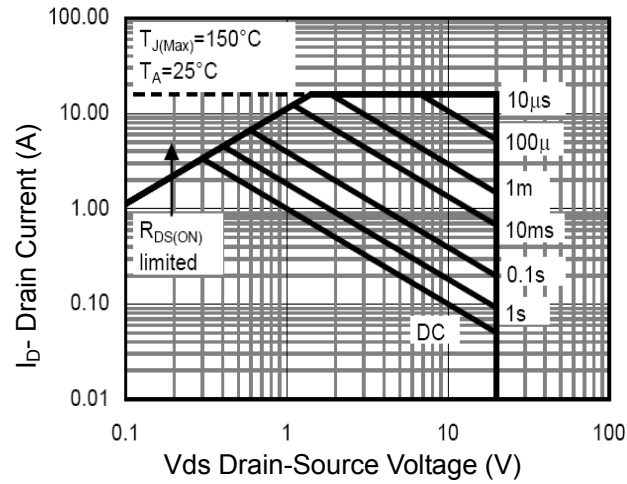

Figure 13 Safe Operation Area

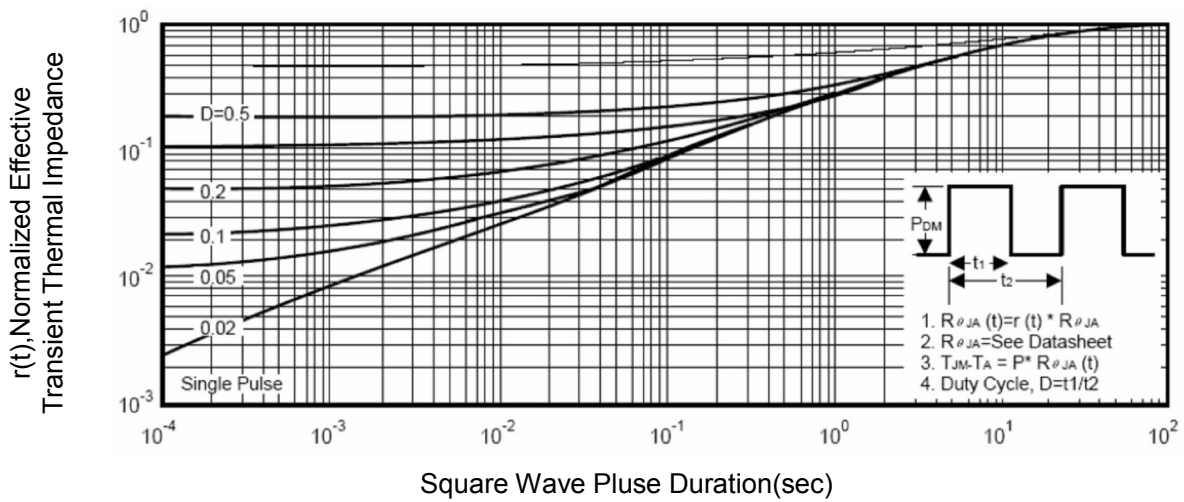
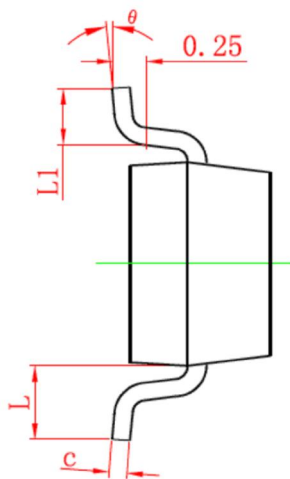
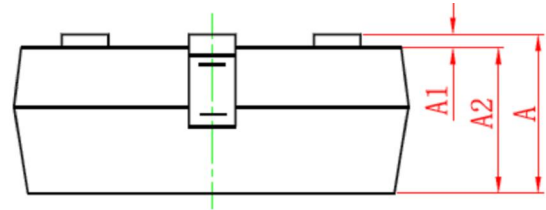
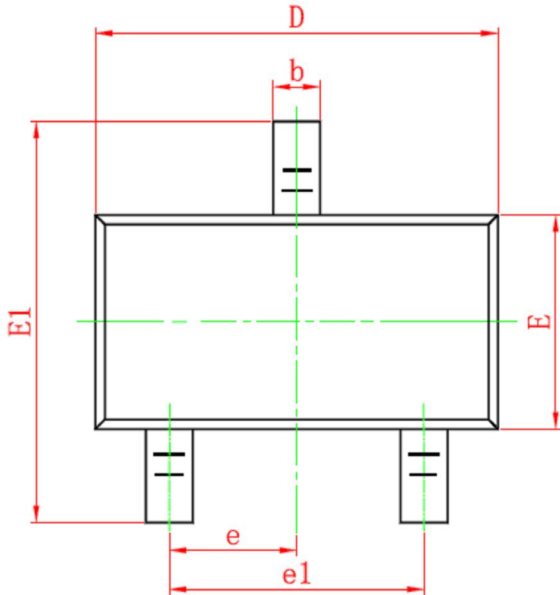

Figure 14 Normalized Maximum Transient Thermal Impedance

SOT-23 PACKAGE INFORMATION

Dimensions in Millimeters (UNIT:mm)



| Symbol | Dimensions in Millimeters | |
|----------|---------------------------|-------|
| | MIN. | MAX. |
| A | 0.900 | 1.150 |
| A1 | 0.000 | 0.100 |
| A2 | 0.900 | 1.050 |
| b | 0.300 | 0.500 |
| c | 0.080 | 0.150 |
| D | 2.800 | 3.000 |
| E | 1.200 | 1.400 |
| E1 | 2.250 | 2.550 |
| e | 0.950TYP | |
| e1 | 1.800 | 2.000 |
| L | 0.550REF | |
| L1 | 0.300 | 0.500 |
| θ | 0° | 8° |

NOTES

- All dimensions are in millimeters.
- Tolerance $\pm 0.10\text{mm}$ (4 mil) unless otherwise specified
- Package body sizes exclude mold flash and gate burrs. Mold flash at the non-lead sides should be less than 5 mils.
- Dimension L is measured in gauge plane.
- Controlling dimension is millimeter, converted inch dimensions are not necessarily exact.