

PowerMESH™ IGBT, S series 600 V, 13 A low drop

Datasheet - production data

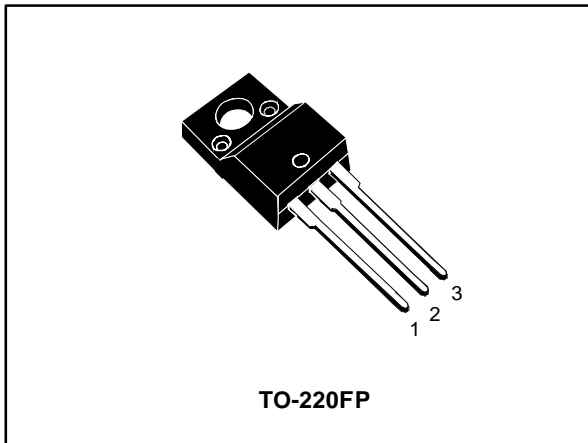
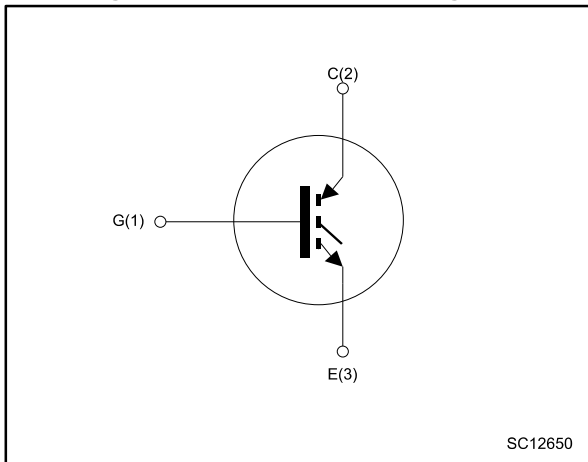

Figure 1: Internal schematic diagram



Features

- Low on-voltage drop ($V_{CE(sat)}$)
- High current capability

Applications

- Light dimmer
- Static relays
- Motor control

Description

Using the latest high voltage technology based on a patented strip layout, STMicroelectronics has designed an advanced family of IGBTs, the PowerMESH™ IGBTs, with outstanding performance. The suffix “S” represents a series optimized to achieve minimum on-voltage drop for low frequency applications.

Table 1: Device summary

Order code	Marking	Package	Packing
STGF20NB60S	GF20NB60S	TO-220FP	Tube

Contents

1	Electrical ratings	3
2	Electrical characteristics	4
	2.1 Electrical characteristics (curves)	6
3	Test circuits	9
4	Package information	10
	4.1 TO-220FP package information	11
5	Revision history	13

1 Electrical ratings

Table 2: Absolute maximum ratings

Symbol	Parameter	Value	Unit
V_{CES}	Collector-emitter voltage ($V_{GE} = 0\text{ V}$)	600	V
V_{ECS}	Emitter-collector voltage ($V_{GE} = 0\text{ V}$)	-20	V
V_{GE}	Gate-emitter voltage	± 20	V
I_C	Continuous collector current at $T_C = 25\text{ °C}$	24	A
	Continuous collector current at $T_C = 100\text{ °C}$	13	
I^{CL}	Turn-off latching current	70	A
$I_{CM}^{(1)}$	Pulsed collector current	70	A
P_{TOT}	Total dissipation at $T_C = 25\text{ °C}$	40	W
V_{ISO}	Insulation withstand voltage (RMS) from all three leads to external heat sink ($t = 1\text{ s}$, $T_C = 25\text{ °C}$)	2.5	kV
T_{STG}	Storage temperature range	-55 to 150	°C
T_J	Operating junction temperature		

Notes:

⁽¹⁾Pulse width limited by safe operating area.

Table 3: Thermal data

Symbol	Parameter	Value	Unit
$R_{thj-case}$	Thermal resistance junction-case	3.1	°C/W
$R_{thj-amb}$	Thermal resistance junction-ambient	62.5	

2 Electrical characteristics

$T_C = 25\text{ °C}$ unless otherwise specified

Table 4: Static characteristics

Symbol	Parameter	Test conditions	Min.	Typ.	Max.	Unit
$V_{(BR)CES}$	Collector-emitter breakdown voltage	$V_{GE} = 0\text{ V}$, $I_C = 250\text{ }\mu\text{A}$	600			V
$V_{(BR)ECS}$	Emitter-collector breakdown voltage	$V_{GE} = 0\text{ V}$, $I_C = 10\text{ mA}$	-20			
I_{CES}	Collector cut-off current	$V_{GE} = 0\text{ V}$, $V_{CE} = 600\text{ V}$			10	μA
		$V_{GE} = 0\text{ V}$, $V_{CE} = 600\text{ V}$, $T_C = 125\text{ °C}$			100	
I_{GES}	Gate-emitter leakage current	$V_{CE} = 0\text{ V}$, $V_{GE} = \pm 20\text{ V}$			± 100	nA
$V_{GE(th)}$	Gate threshold voltage	$V_{CE} = V_{GE}$, $I_C = 250\text{ }\mu\text{A}$	2.5		5	V
$V_{CE(sat)}$	Collector-emitter saturation voltage	$V_{GE} = 15\text{ V}$, $I_C = 20\text{ A}$		1.25	1.7	V
		$V_{GE} = 15\text{ V}$, $I_C = 20\text{ A}$, $T_J = 150\text{ °C}$		1.2		

Table 5: Dynamic characteristics

Symbol	Parameter	Test conditions	Min.	Typ.	Max.	Unit
$g_{fs}^{(1)}$	Forward transconductance	$V_{CE} = 10\text{ V}$, $I_C = 8\text{ A}$	-	20	-	S
C_{ies}	Input capacitance	$V_{CE} = 25\text{ V}$, $f = 1\text{ MHz}$, $V_{GE} = 0\text{ V}$	-	1820	-	μF
C_{oes}	Output capacitance		-	167	-	
C_{res}	Reverse transfer capacitance		-	27	-	
Q_g	Total gate charge	$V_{CC} = 480\text{ V}$, $I_C = 20\text{ A}$, $V_{GE} = 15\text{ V}$ (see Figure 17 : "Gate charge test circuit")	-	83	115	nC
Q_{ge}	Gate-emitter charge		-	10	-	
Q_{gc}	Gate-collector charge		-	27	-	

Notes:

⁽¹⁾Pulse duration= 300 μs , duty cycle 1.5 %

Table 6: Inductive load switching on characteristics

Symbol	Parameter	Test conditions	Min.	Typ.	Max.	Unit
$t_{d(on)}$	Turn-on delay time	$V_{CC} = 480\text{ V}$, $I_C = 20\text{ A}$, $V_{GE} = 15\text{ V}$, $R_G = 100\text{ }\Omega$ (see Figure 16 : "Test circuit for inductive load switching")	-	92	-	ns
t_r	Current rise time		-	70	-	ns
$(di/dt)_{on}$	Turn-on current slope		-	340	-	A/ μs
$t_{d(on)}$	Turn-on delay time	$V_{CC} = 480\text{ V}$, $I_C = 20\text{ A}$, $V_{GE} = 15\text{ V}$, $R_G = 100\text{ }\Omega$, $T_J = 125\text{ °C}$ (see Figure 16 : "Test circuit for inductive load switching")	-	80	-	ns
t_r	Current rise time		-	73	-	ns
$(di/dt)_{on}$	Turn-on current slope		-	320	-	A/ μs

Table 7: Inductive load switching off characteristics

Symbol	Parameter	Test conditions	Min.	Typ.	Max.	Unit
t_c	Cross-over time	$V_{CC} = 480\text{ V}$, $I_C = 20\text{ A}$, $V_{GE} = 15\text{ V}$, $R_G = 100\ \Omega$ (see Figure 16: "Test circuit for inductive load switching")	-	1.6	-	ns
$t_r(V_{off})$	Off voltage rise time		-	0.8	-	
$t_{d(off)}$	Turn-off delay time		-	1.1	-	
t_f	Current fall time		-	0.8	-	
t_c	Cross-over time	$V_{CC} = 480\text{ V}$, $I_C = 20\text{ A}$, $V_{GE} = 15\text{ V}$, $R_G = 100\ \Omega$, $T_j = 125\text{ }^\circ\text{C}$ (see Figure 16: "Test circuit for inductive load switching")	-	2.4	-	ns
$t_r(V_{off})$	Off voltage rise time		-	1.1	-	
$t_{d(off)}$	Turn-off delay time		-	2.4	-	
t_f	Current fall time		-	1.2	-	

Table 8: Inductive load switching loss characteristics

Symbol	Parameter	Test conditions	Min.	Typ.	Max.	Unit
$E_{on}^{(1)}$	Turn-on switching loss	$V_{CC} = 480\text{ V}$, $I_C = 20\text{ A}$, $V_{GE} = 15\text{ V}$, $R_G = 100\ \Omega$ (see Figure 18: "Switching waveform")	-	0.84	-	mJ
$E_{off}^{(2)}$	Turn-off switching loss		-	7.4	-	
E_{ts}	Total switching loss		-	8.24	-	
$E_{on}^{(1)}$	Turn-on switching loss	$V_{CC} = 480\text{ V}$, $I_C = 20\text{ A}$, $V_{GE} = 15\text{ V}$, $R_G = 100\ \Omega$, $T_j = 125\text{ }^\circ\text{C}$ (see Figure 18: "Switching waveform")	-	0.86	-	mJ
$E_{off}^{(2)}$	Turn-off switching loss		-	11.5	-	
E_{ts}	Total switching loss		-	12.36	-	

Notes:

⁽¹⁾ E_{on} is the turn-on loss when an external diode is used in the test circuit in [Figure 16: "Test circuit for inductive load switching"](#).

⁽²⁾Turn-off loss includes the tail of the collector current.

2.1 Electrical characteristics (curves)

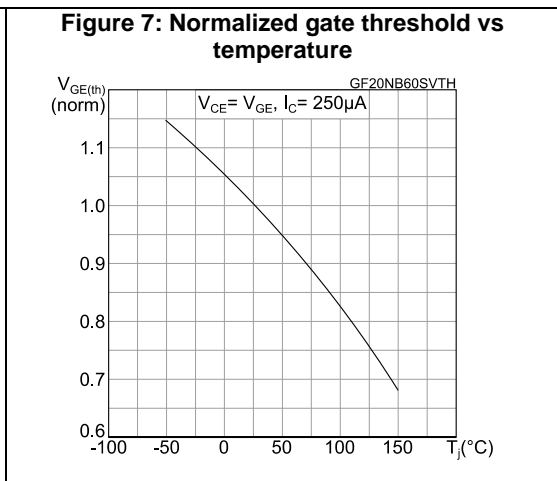
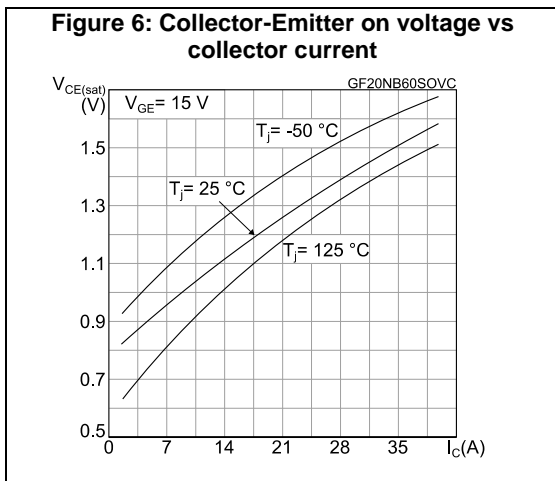
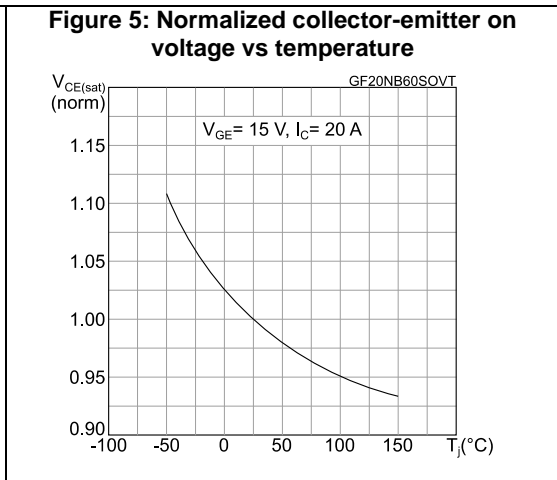
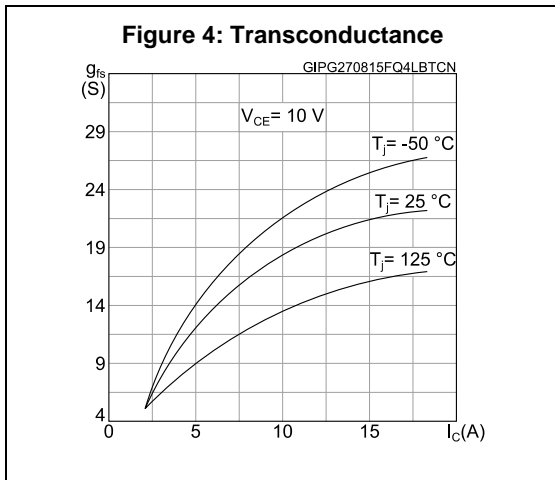
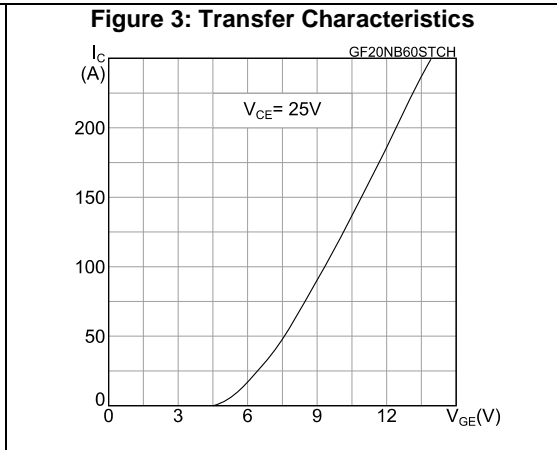
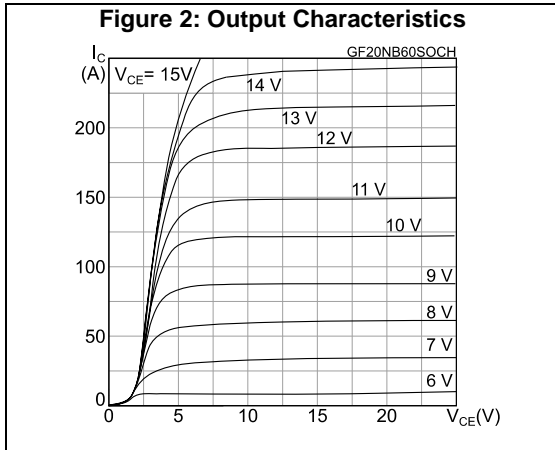

Figure 8: Normalized breakdown voltage vs temperature

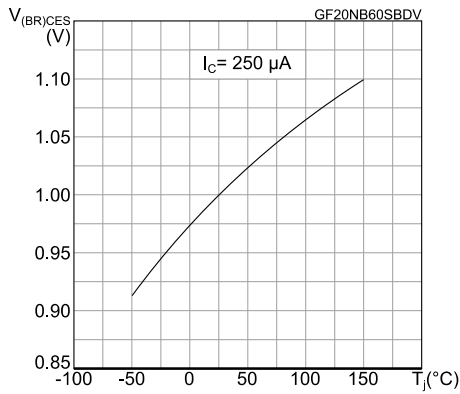

Figure 9: Gate charge vs gate-emitter voltage

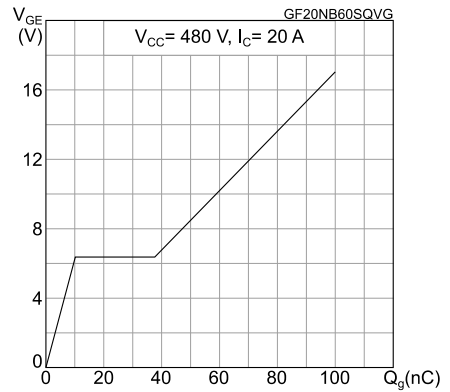

Figure 10: Capacitance variations

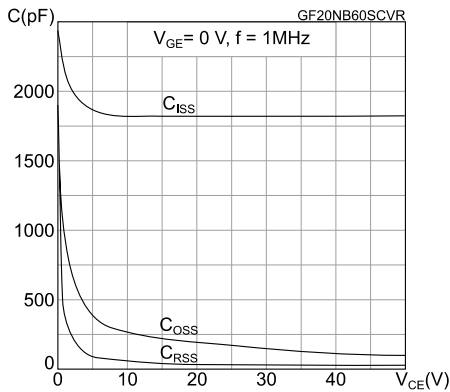

Figure 11: Switching loss vs gate resistance

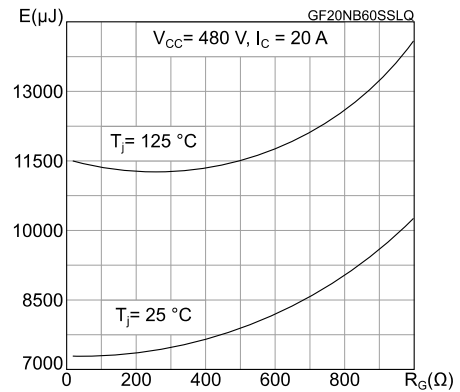

Figure 12: Switching loss vs temperature

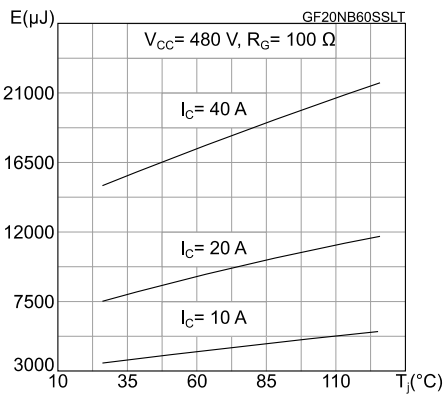
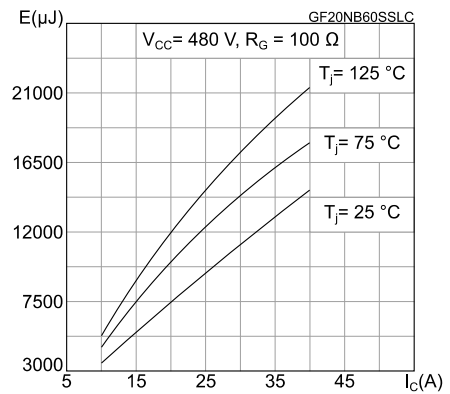
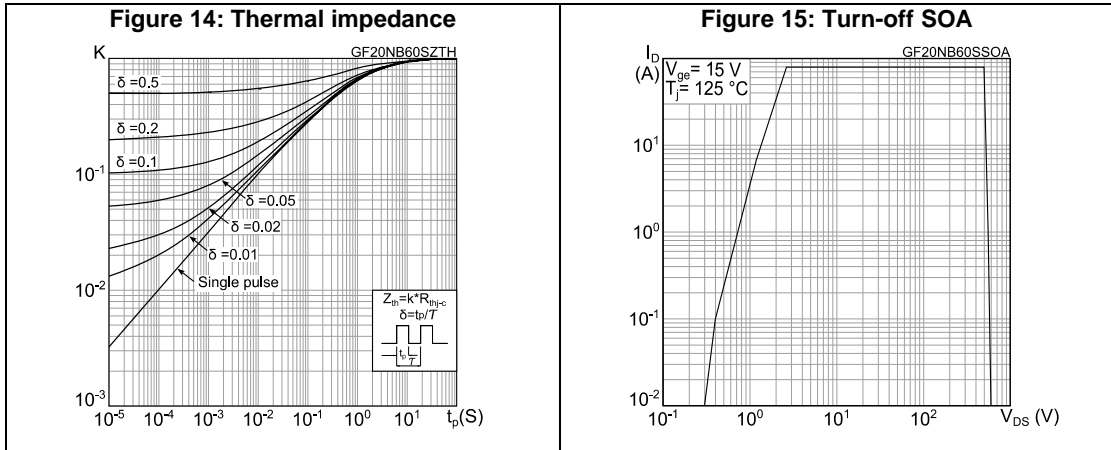

Figure 13: Switching loss vs collector current





3 Test circuits

Figure 16: Test circuit for inductive load switching

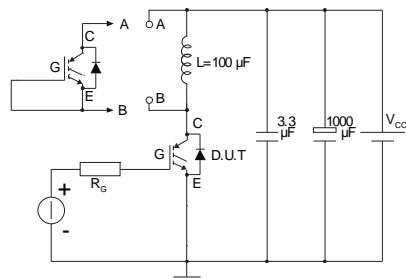

AM01504v1

Figure 17: Gate charge test circuit

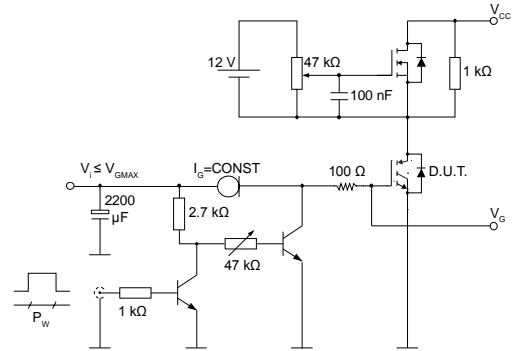

AM01505v1

Figure 18: Switching waveform

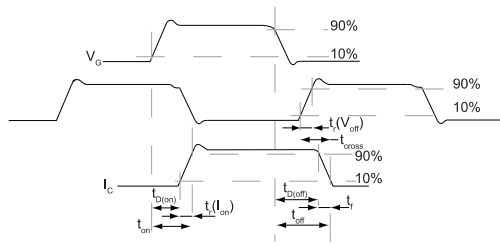

AM01506v1

4 Package information

In order to meet environmental requirements, ST offers these devices in different grades of ECOPACK® packages, depending on their level of environmental compliance. ECOPACK® specifications, grade definitions and product status are available at: www.st.com. ECOPACK® is an ST trademark.

4.1 TO-220FP package information

Figure 19: TO-220FP package outline

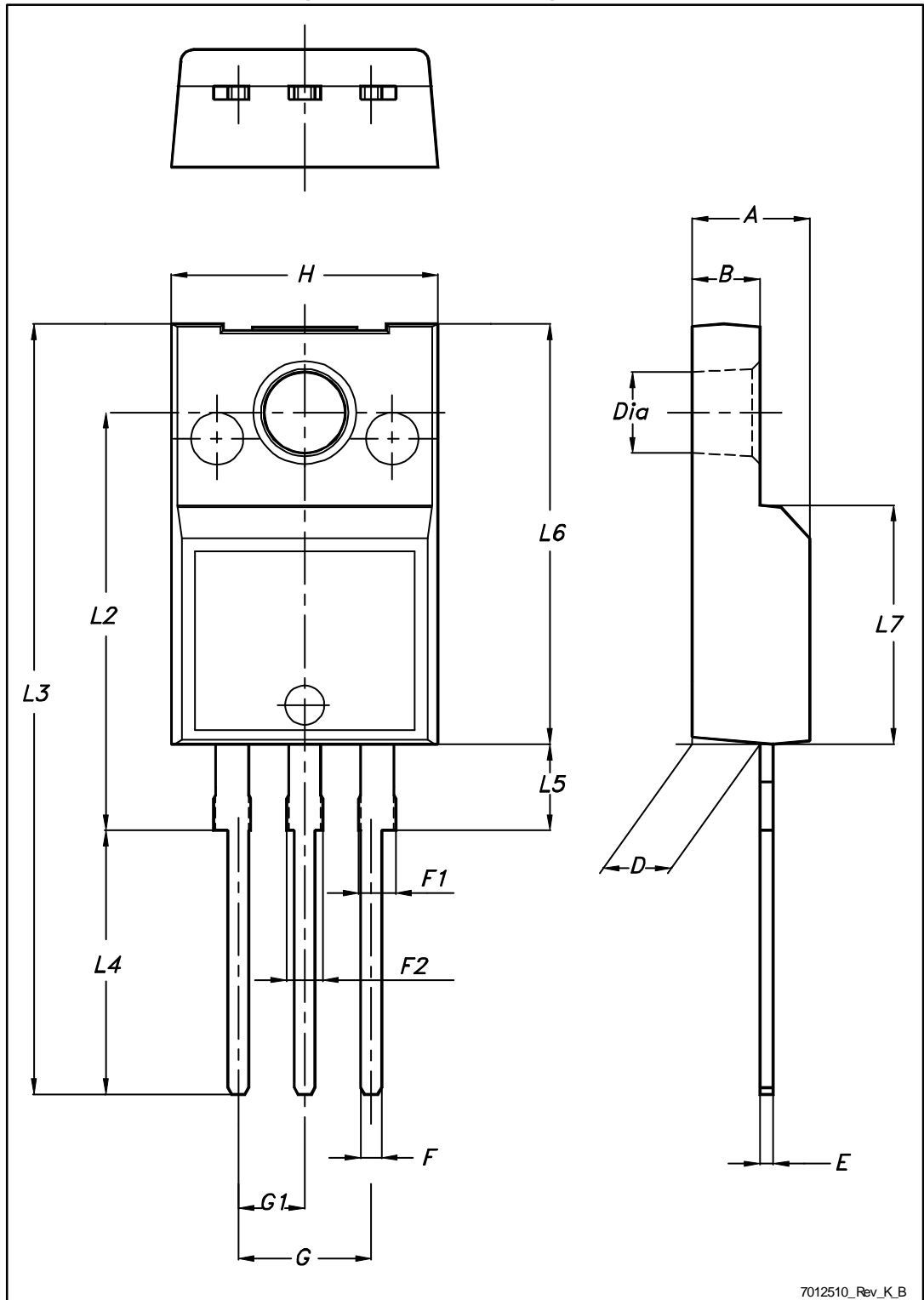

7012510_Rev_K.B

Table 9: TO-220FP package mechanical data

Dim.	mm		
	Min.	Typ.	Max.
A	4.4		4.6
B	2.5		2.7
D	2.5		2.75
E	0.45		0.7
F	0.75		1
F1	1.15		1.70
F2	1.15		1.70
G	4.95		5.2
G1	2.4		2.7
H	10		10.4
L2		16	
L3	28.6		30.6
L4	9.8		10.6
L5	2.9		3.6
L6	15.9		16.4
L7	9		9.3
Dia	3		3.2

5 Revision history

Table 10: Document revision history

Date	Revision	Changes
17-Dec-2004	2	New template, no content change
05-Aug-2005	3	Some values changed in table 6
02-Dec-2015	4	Text and formatting changes throughout document On cover page: - updated Title, Features and Description Added Electrical ratings section heading In section Electrical ratings: - updated tables Absolute Maximum ratings and Thermal Data In section Electrical characteristics: - updated table Static characteristics Added section Package information Updated TO-220FP package information

IMPORTANT NOTICE – PLEASE READ CAREFULLY

STMicroelectronics NV and its subsidiaries ("ST") reserve the right to make changes, corrections, enhancements, modifications, and improvements to ST products and/or to this document at any time without notice. Purchasers should obtain the latest relevant information on ST products before placing orders. ST products are sold pursuant to ST's terms and conditions of sale in place at the time of order acknowledgement.

Purchasers are solely responsible for the choice, selection, and use of ST products and ST assumes no liability for application assistance or the design of Purchasers' products.

No license, express or implied, to any intellectual property right is granted by ST herein.

Resale of ST products with provisions different from the information set forth herein shall void any warranty granted by ST for such product.

ST and the ST logo are trademarks of ST. All other product or service names are the property of their respective owners.

Information in this document supersedes and replaces information previously supplied in any prior versions of this document.

© 2015 STMicroelectronics – All rights reserved