



N-Channel Enhancement-Mode MOSFET

V_{DS} 30V $R_{DS(ON)}$ 0.117 Ω I_D 2.5A

TO-236AB (SOT-23)

TRENCH GENFET

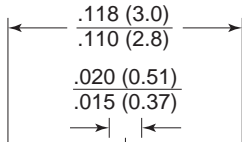

Top View

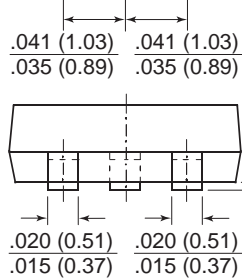
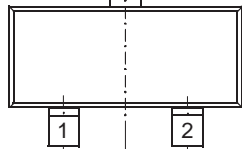

Dimensions in inches and (millimeters)

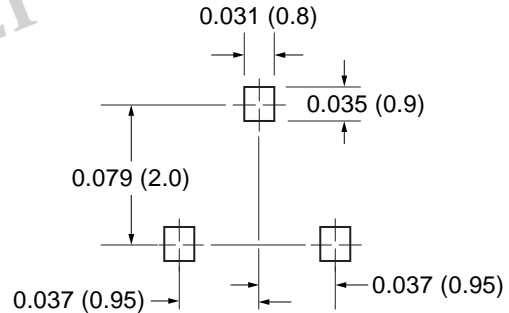
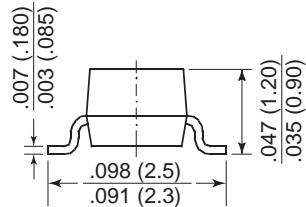

Mounting Pad Layout

Mechanical Data

Case: SOT-23 Plastic Package
Weight: approx. 0.008g
Marking Code: 04

Features

- Advanced trench process technology
- High density cell design for ultra-low on-resistance
- Popular SOT-23 package with copper lead-frame for superior thermal and electrical capabilities
- Compact and low profile

Maximum Ratings and Thermal Characteristics ($T_A = 25^\circ\text{C}$ unless otherwise noted)

Parameter	Symbol	Limit	Unit
Drain-Source Voltage	V_{DS}	30	V
Gate-Source-Voltage	V_{GS}	± 20	V
Continuous Drain Current $T_J = 150^\circ\text{C}$ $T_A = 25^\circ\text{C}$	I_D	2.5	A
Pulsed Drain Current ⁽¹⁾	I_{DM}	10	A
Maximum Power Dissipation ⁽²⁾ $T_A = 25^\circ\text{C}$ $T_A = 70^\circ\text{C}$	P_D	1.25 0.80	W
Operating Junction and Storage Temperature Range	T_J, T_{stg}	-55 to +150	$^\circ\text{C}$
Maximum Junction-to-Ambient Thermal Resistance ⁽²⁾	$R_{\theta JA}$	100	$^\circ\text{C/W}$

Notes:

- (1) Pulse width limited by maximum junction temperature.
(2) Surface mounted on FR4 board, (1" x 1", 2oz. Cu)

N-Channel Enhancement-Mode MOSFET

V_{DS} 30V $R_{DS(on)}$ 0.117 Ω I_D 2.5A

Electrical Characteristics ($T_J = 25^\circ\text{C}$ unless otherwise noted)

Parameter	Symbol	Test Condition	Min	Typ	Max	Unit
Static						
Drain-Source Breakdown Voltage	BV_{DSS}	$V_{GS} = 0V, I_D = 250\mu A$	30	—	—	V
Gate Threshold Voltage	$V_{GS(th)}$	$V_{DS} = V_{GS}, I_D = 250\mu A$	1.0	—	—	V
Gate-Body Leakage	I_{GSS}	$V_{DS} = 0V, V_{GS} = \pm 20V$	—	—	± 100	nA
Zero Gate Voltage Drain Current	I_{DSS}	$V_{DS} = 30V, V_{GS} = 0V$	—	—	0.5	μA
		$V_{DS}=30V, V_{GS}=0V, T_J=55^\circ C$	—	—	10	
On-State Drain Current ⁽¹⁾	$I_{D(on)}$	$V_{DS} \geq 4.5V, V_{GS} = 10V$	6	—	—	A
		$V_{DS} \geq 4.5V, V_{GS} = 4.5V$	4	—	—	
Drain-Source On-State Resistance ⁽¹⁾	$R_{DS(on)}$	$V_{GS} = 10V, I_D = 2.5A$	—	0.096	0.117	Ω
		$V_{GS} = 4.5V, I_D = 2.0A$	—	0.135	0.190	
Forward Transconductance ⁽¹⁾	g_{fs}	$V_{DS} = 4.5V, I_D = 2.5A$	—	4.6	—	S
Dynamic						
Total Gate Charge	Q_g	$V_{DS} = 15V, V_{GS} = 10V$ $I_D = 2.5A$	—	3.7	10	nC
Gate-Source Charge	Q_{gs}		—	0.5	—	
Gate-Drain Charge	Q_{gd}		—	0.6	—	
Turn-On Delay Time	$t_{d(on)}$	$V_{DD} = 15V, R_L = 15\Omega$ $I_D \approx 1A, V_{GEN} = 10V$ $R_G = 6\Omega$	—	6	20	ns
Rise Time	t_r		—	8.8	30	
Turn-Off Delay Time	$t_{d(off)}$		—	26	35	
Fall Time	t_f		—	2.4	20	
Input Capacitance	C_{iss}	$V_{GS} = 0V$	—	163	—	pF
Output Capacitance	C_{oss}	$V_{DS} = 15V$	—	27	—	
Reverse Transfer Capacitance	C_{rss}	$f = 1.0MHz$	—	9	—	
Source-Drain Diode						
Maximum Diode Forward Current	I_S	—	—	—	2.1	A
Diode Forward Voltage	V_{SD}	$I_S = 1.25A, V_{GS} = 0V$	—	0.82	1.2	V

Note: (1) Pulse test; pulse width $\leq 300 \mu s$, duty cycle $\leq 2\%$

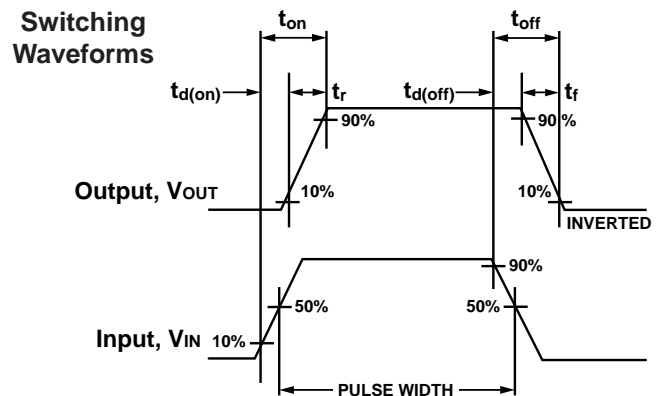
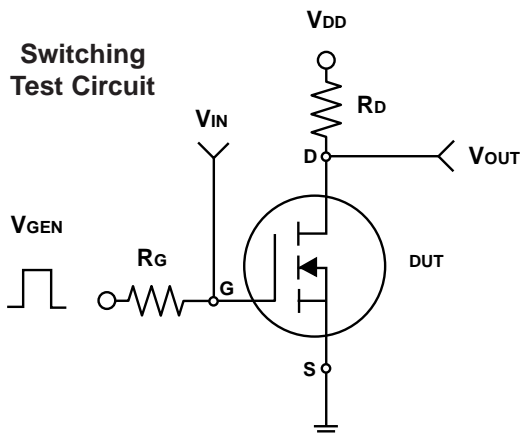

N-Channel Enhancement-Mode MOSFET

Ratings and Characteristic Curves (T_A = 25°C unless otherwise noted)

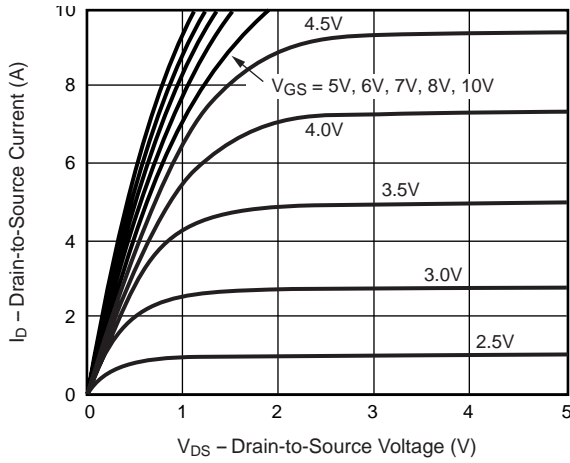

Fig. 3 – Capacitance

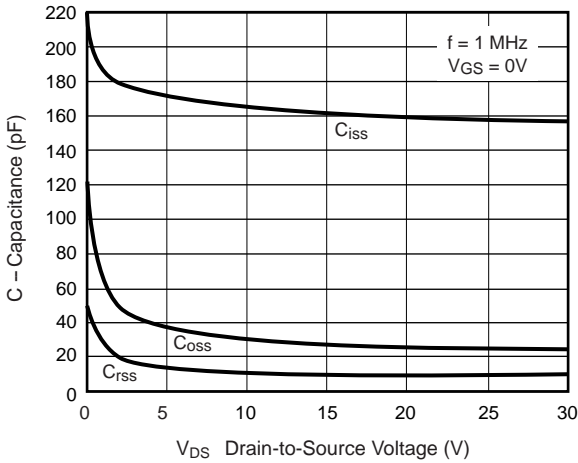

Fig. 4 – On-Resistance vs. Drain Current

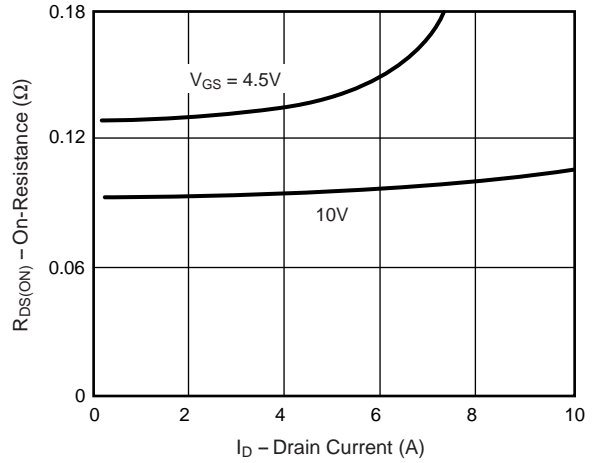
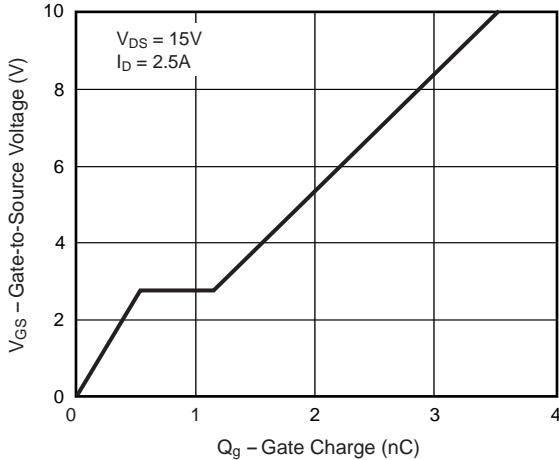

Fig. 5 – Gate Charge



N-Channel Enhancement-Mode MOSFET

Ratings and Characteristic Curves (T_A = 25°C unless otherwise noted)

Fig. 6 – On-Resistance vs. Gate-to-Source Voltage

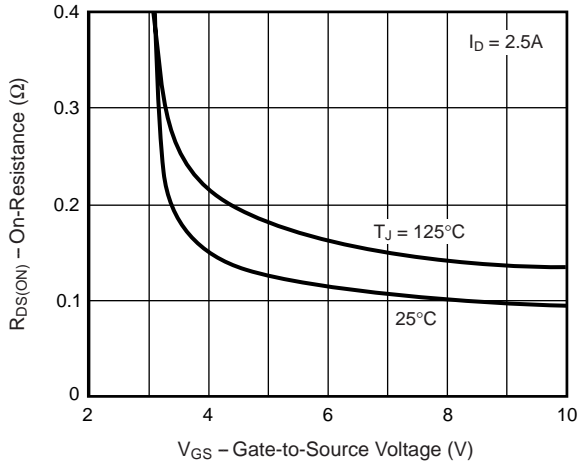

Fig. 7 – Source-Drain Diode Forward Voltage

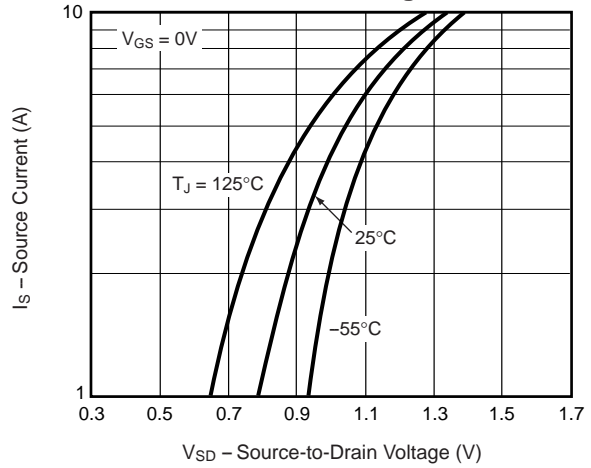

Fig. 8 – Breakdown Voltage vs. Junction Temperature

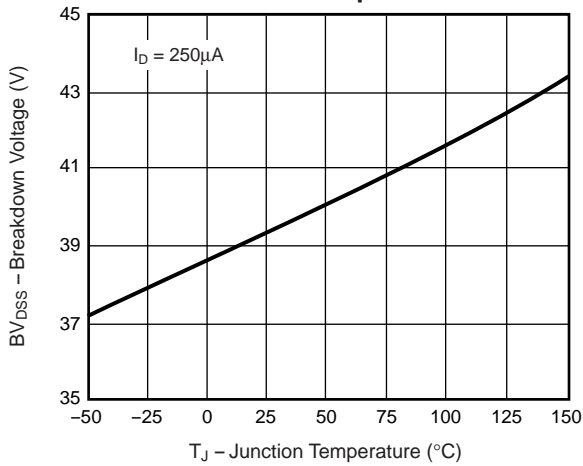
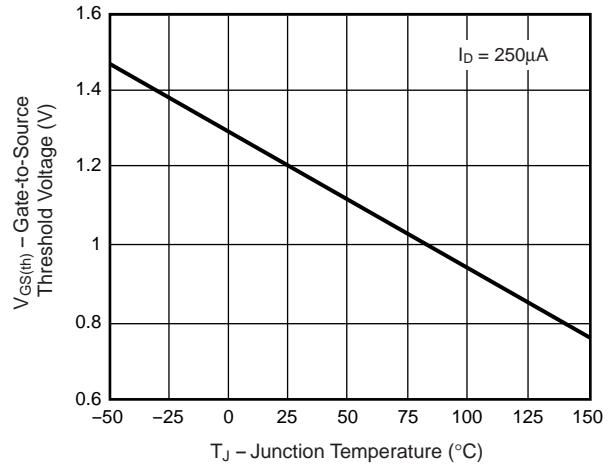

Fig. 9 – Threshold Voltage



N-Channel Enhancement-Mode MOSFET

Ratings and Characteristic Curves ($T_A = 25^\circ\text{C}$ unless otherwise noted)

Fig. 10 – On-Resistance vs. Junction Temperature

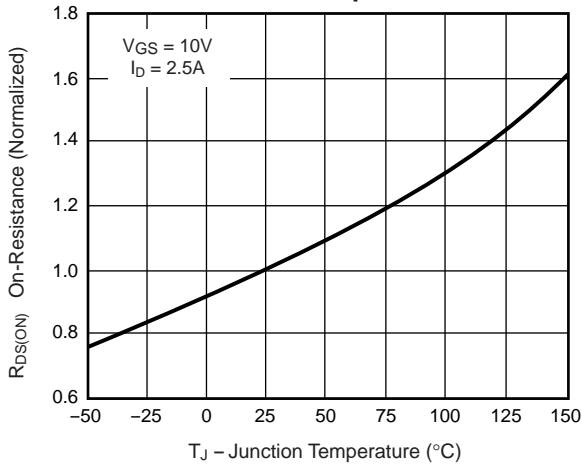

Fig. 11 – Thermal Impedance

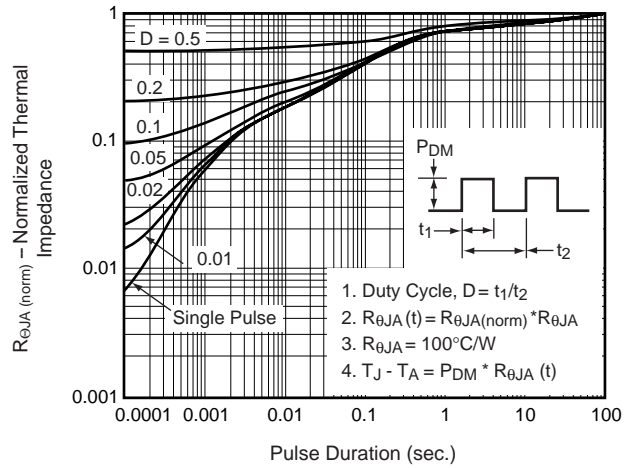

Fig. 12 – Power vs. Pulse Duration

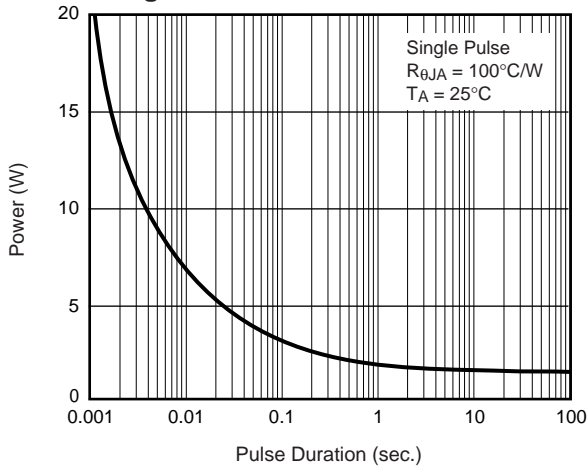

Fig. 13 – Maximum Safe Operating Area

