

TRENCH GENFET®

N-Channel Enhancement-Mode MOSFET

V_{DS} 30V R_{DS(ON)} 28mΩ I_D 7A

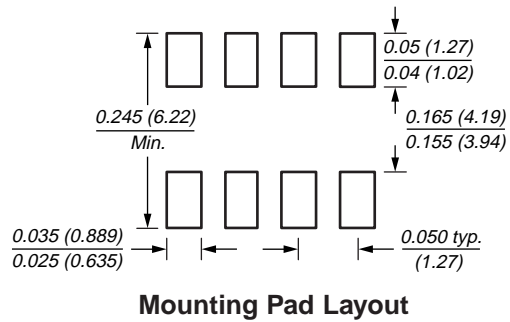
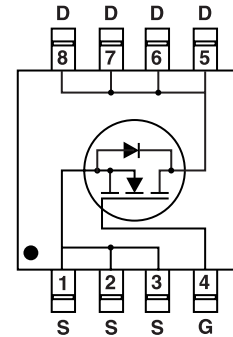
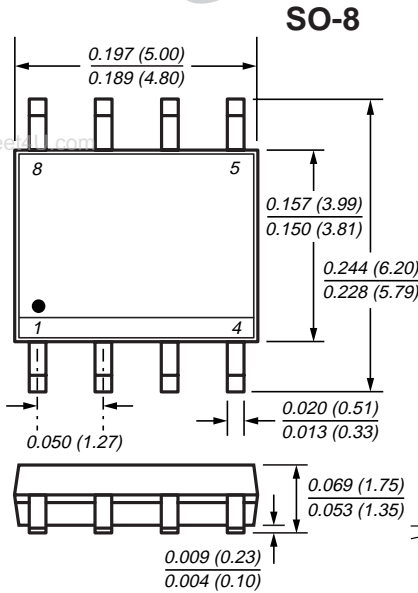

Mechanical Data

Case: SO-8 molded plastic body
Terminals: Leads solderable per MIL-STD-750, Method 2026
High temperature soldering guaranteed: 250°C/10 seconds at terminals
Mounting Position: Any **Weight:** 0.5g

Features

- Advanced Trench Process Technology
- High Density Cell Design for Ultra Low On-Resistance
- Specially Designed for Low Voltage DC/DC Converters
- Fast Switching for High Efficiency

Maximum Ratings and Thermal Characteristics (T_A = 25°C unless otherwise noted)

Parameter	Symbol	Limit	Unit
Drain-Source Voltage	V _{DS}	30	V
Gate-Source Voltage	V _{GS}	±20	
Continuous Drain Current T _J = 150°C ⁽¹⁾	I _D	T _A = 25°C 7	A
		T _A = 70°C 5.8	
Pulsed Drain Current	I _{DM}	30	
Continuous Source Current (Diode Conduction) ⁽¹⁾	I _S	2.3	
Maximum Power Dissipation ⁽¹⁾	P _D	T _A = 25°C 2.5	W
		T _A = 70°C 1.6	
Operating Junction and Storage Temperature Range	T _J , T _{stg}	-55 to 150	°C
Maximum Junction-to-Ambient ⁽¹⁾ Thermal Resistance	R _{θJA}	50	°C/W

Notes: (1) Surface mounted on FR4 board, t ≤ 10 sec.

N-Channel Enhancement-Mode MOSFET

Electrical Characteristics (T_J = 25°C unless otherwise noted)

Parameter	Symbol	Test Condition	Min	Typ	Max	Unit
Static						
Drain-Source Breakdown Voltage	BV _{DSS}	V _{GS} = 0V, I _D = 250μA	30	–	–	V
Gate Threshold Voltage	V _{GS(th)}	V _{DS} = V _{GS} , I _D = 250μA	1	–	3	V
Gate-Body Leakage	I _{GSS}	V _{GS} = ±20V, V _{DS} = 0V	–	–	±100	nA
Zero Gate Voltage Drain Current	I _{DSS}	V _{DS} = 30V, V _{GS} = 0V	–	–	1	μA
		V _{DS} = 30V, V _{GS} = 0V, T _J = 55°C	–	–	5	
On-State Drain Current ⁽¹⁾	I _{D(on)}	V _{DS} ≥ 5V, V _{GS} = 10V	30	–	–	A
Drain-Source On-State Resistance ⁽¹⁾	R _{DS(on)}	V _{GS} = 10V, I _D = 7A	–	20	28	mΩ
		V _{GS} = 4.5V, I _D = 3.5A	–	29	42	
Forward Transconductance ⁽¹⁾	g _{fs}	V _{DS} = 15V, I _D = 7A	–	16	–	S
Dynamic						
Total Gate Charge	Q _g	V _{DS} = 15V, I _D = 2A V _{GS} = 10V	–	16	23	nC
Gate-Source Charge	Q _{gs}		–	2.2	–	
Gate-Drain Charge	Q _{gd}		–	2.4	–	
Turn-On Delay Time	t _{d(on)}	V _{DD} = 15V, I _D = 1A V _{GEN} = 10V, R _G = 6Ω R _L = 15Ω	–	6	12	ns
Turn-On Rise Time	t _r		–	5	10	
Turn-Off Delay Time	t _{d(off)}		–	25	37	
Turn-Off Fall Time	t _f		–	7	14	
Input Capacitance	C _{iss}	V _{DS} = 15V	–	810	–	pF
Output Capacitance	C _{oss}	V _{GS} = 0V	–	150	–	
Reverse Transfer Capacitance	C _{rss}	f = 1.0MHz	–	75	–	
Source-Drain Diode						
Diode Forward Voltage ⁽¹⁾	V _{SD}	I _S = 2A, V _{GS} = 0V	–	0.75	1.3	V

Notes: (1) Pulse test; pulse width ≤ 300 μs, duty cycle ≤ 2%

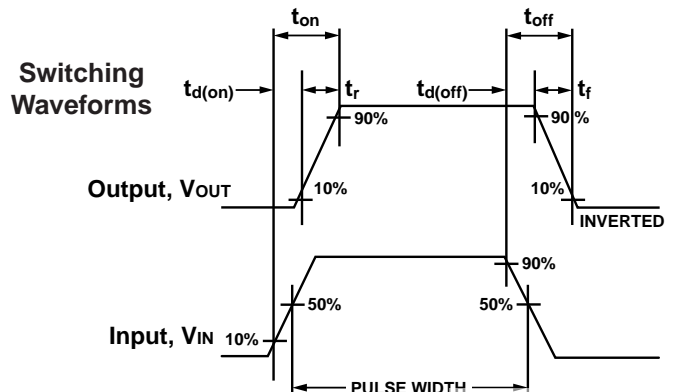
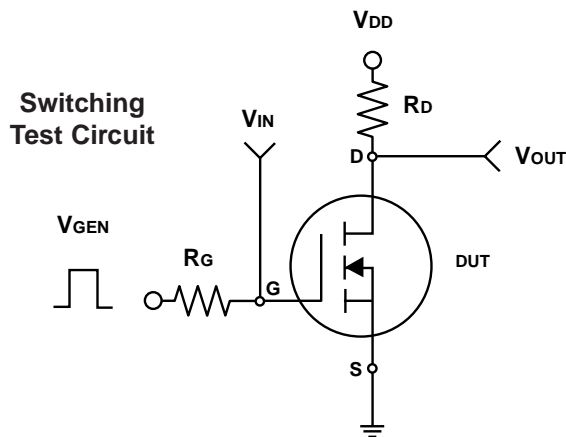

N-Channel Enhancement-Mode MOSFET

Ratings and Characteristic Curves (T_A = 25°C unless otherwise noted)

Fig. 1 – Output Characteristics

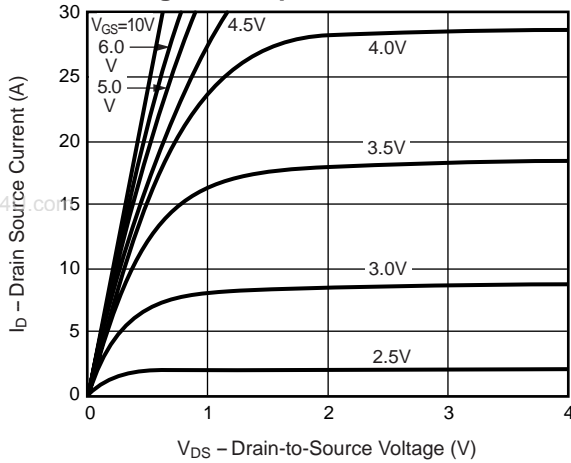

Fig. 2 – Transfer Characteristics

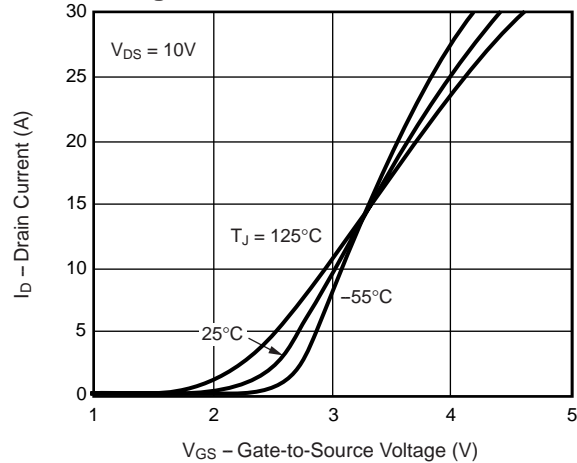

Fig. 3 – Threshold Voltage vs. Temperature

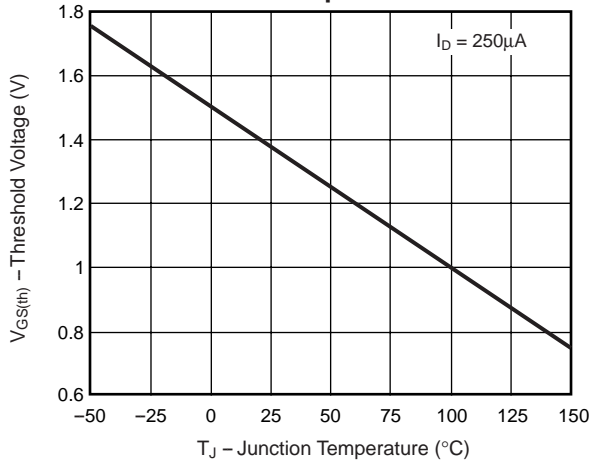

Fig. 4 – On-Resistance vs. Drain Current

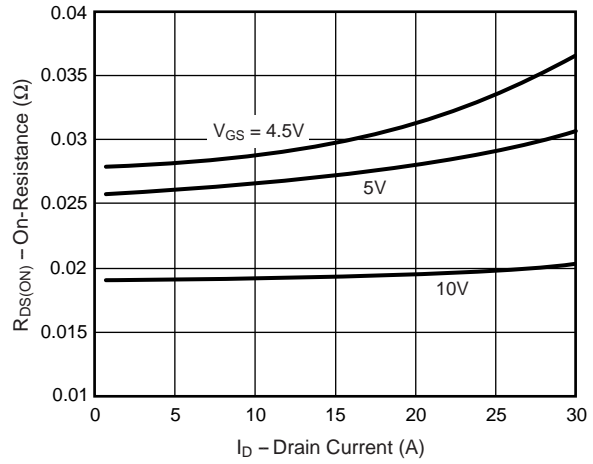
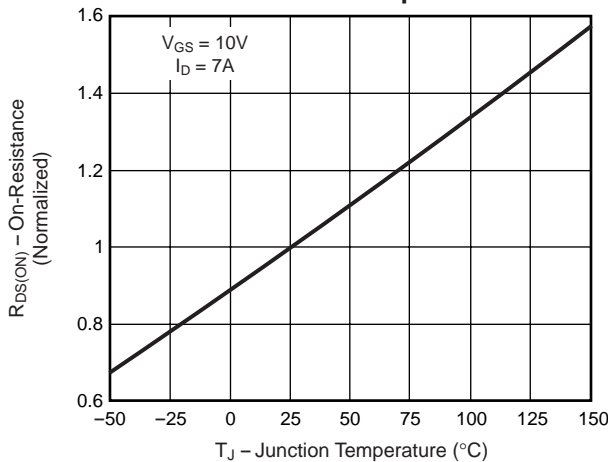

Fig. 5 – On-Resistance vs. Junction Temperature



N-Channel Enhancement-Mode MOSFET

Ratings and Characteristic Curves (T_A = 25°C unless otherwise noted)

Fig. 6 – On-Resistance vs. Gate-to-Source Voltage

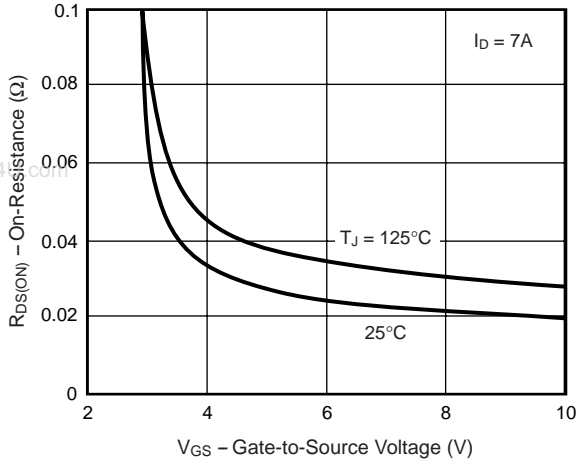

Fig. 7 – Gate Charge

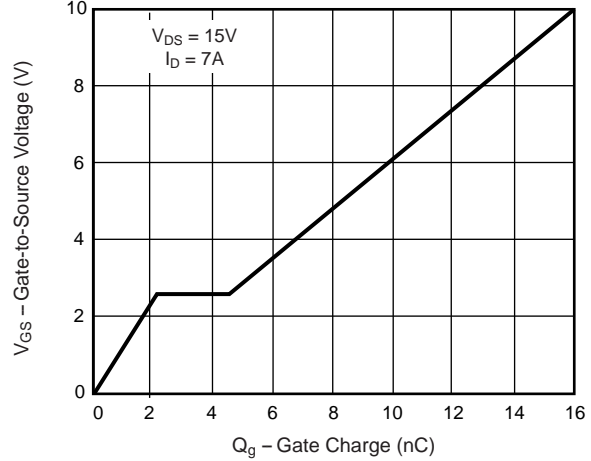

Fig. 8 – Capacitance

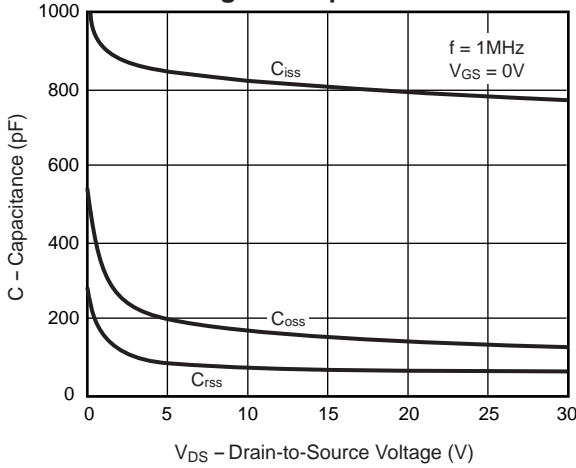
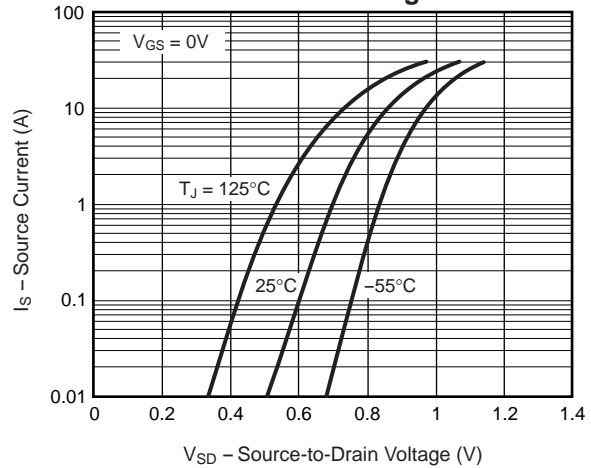

Fig. 9 – Source-Drain Diode Forward Voltage



N-Channel Enhancement-Mode MOSFET

Ratings and Characteristic Curves (T_A = 25°C unless otherwise noted)

Fig. 10 – Breakdown Voltage vs. Junction Temperature

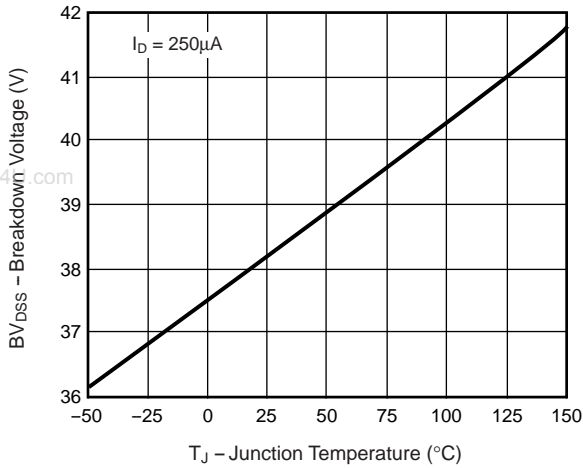

Fig. 11 – Transient Thermal Impedance

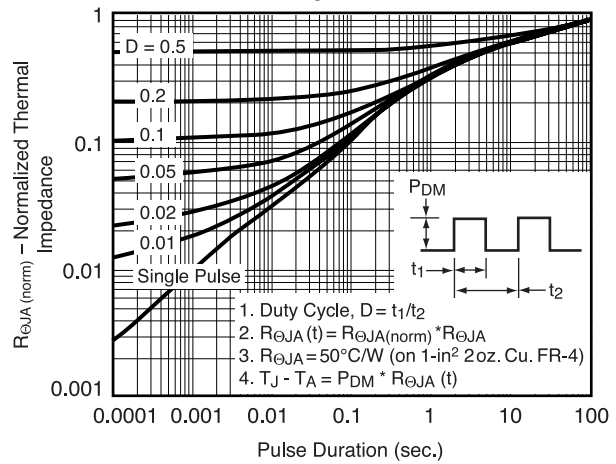

Fig. 12 – Power vs. Pulse Duration

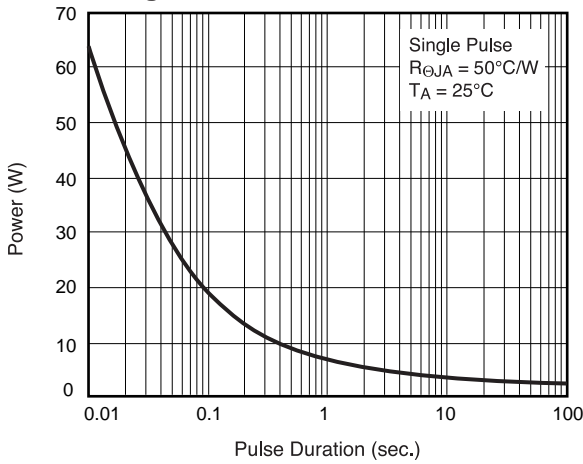

Fig. 13 – Maximum Safe Operating Area

