

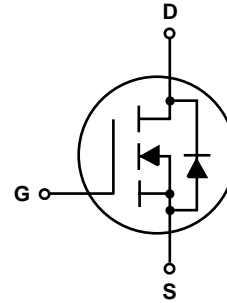

**N-Channel Enhancement-Mode MOSFET**

$V_{DS}$  30V  $R_{DS(ON)}$  13m $\Omega$   $I_D$  50A



**TO-263AB**

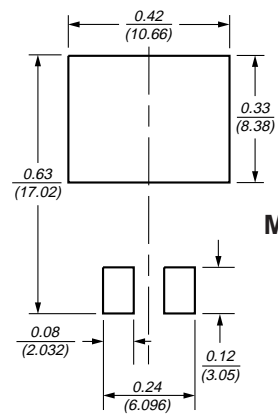
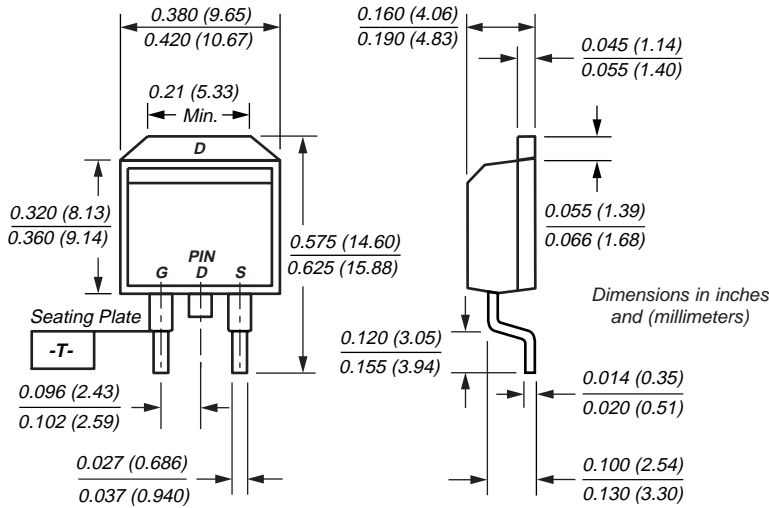

**Mechanical Data**

**Case:** JEDEC TO-263 molded plastic body  
**Terminals:** Leads solderable per MIL-STD-750, Method 2026  
**High temperature soldering guaranteed:** 250°C/10 seconds at terminals  
**Mounting Position:** Any    **Weight:** 1.3g

**Features**

- Advanced Trench Process Technology
- High Density Cell Design for Ultra Low On-Resistance
- Specially Designed for Low Voltage DC/DC Converters
- Fast Switching for High Efficiency

**Maximum Ratings and Thermal Characteristics** ( $T_C = 25^\circ\text{C}$  unless otherwise noted)

Parameter	Symbol	Limit	Unit	
Drain-Source Voltage	$V_{DS}$	30	V	
Gate-Source Voltage	$V_{GS}$	$\pm 20$		
Continuous Drain Current <sup>(1)</sup>	$I_D$	50	A	
Pulsed Drain Current	$I_{DM}$	100		
Maximum Power Dissipation	$P_D$	$T_C = 25^\circ\text{C}$ $T_C = 100^\circ\text{C}$	62.5 25	W
Operating Junction and Storage Temperature Range		$T_J, T_{stg}$	-55 to 150	$^\circ\text{C}$
Lead Temperature (1/8" from case for 5 sec.)	$T_L$	275	$^\circ\text{C}$	
Junction-to-Case Thermal Resistance	$R_{\theta JC}$	2.0	$^\circ\text{C/W}$	
Junction-to-Ambient Thermal Resistance <sup>(2)</sup>	$R_{\theta JA}$	40	$^\circ\text{C/W}$	

**Notes:** (1) Maximum DC current limited by the package  
 (2) 1-in<sup>2</sup> 2oz. Cu PCB mounted

**N-Channel Enhancement-Mode MOSFET**

[www.DataSheet.in](http://www.DataSheet.in)

**Electrical Characteristics** ( $T_J = 25^\circ\text{C}$  unless otherwise noted)

Parameter	Symbol	Test Condition	Min	Typ	Max	Unit
<b>Static</b>						
Drain-Source Breakdown Voltage	$BV_{DSS}$	$V_{GS} = 0V, I_D = 250\mu A$	30			V
Gate Threshold Voltage	$V_{GS(th)}$	$V_{DS} = V_{GS}, I_D = 250\mu A$	1.0		3.0	
Gate-Body Leakage	$I_{GSS}$	$V_{DS} = 0V, V_{GS} = \pm 20V$			$\pm 100$	nA
Zero Gate Voltage Drain Current	$I_{DSS}$	$V_{DS} = 30V, V_{GS} = 0V$			1	$\mu A$
On-State Drain Current <sup>(1)</sup>	$I_{D(on)}$	$V_{DS} \geq 5V, V_{GS} = 10V$	60			A
Drain-Source On-State Resistance <sup>(1)</sup>	$R_{DS(on)}$	$V_{GS} = 10V, I_D = 25A$		11	13	m $\Omega$
		$V_{GS} = 4.5V, I_D = 20A$		15	20	
Forward Transconductance <sup>(1)</sup>	$g_{fs}$	$V_{DS} = 10V, I_D = 25A$		40		S
Diode Forward Voltage	$V_{SD}$	$I_S = 25A, V_{GS} = 0V$		0.9	1.3	V
<b>Dynamic<sup>(1)</sup></b>						
Total Gate Charge	$Q_g$	$V_{DS}=15V, V_{GS}=5V, I_D=50A$		16	22	nC
		$V_{DS} = 15V, V_{GS} = 10V, I_D = 50A$		35	60	
Gate-Source Charge	$Q_{gs}$	$V_{DS} = 15V, V_{GS} = 10V, I_D = 50A$		8		
Gate-Drain Charge	$Q_{gd}$			6		
Turn-On Delay Time	$t_{d(on)}$	$V_{DD} = 15V, R_L = 15\Omega, I_D \approx 1A, V_{GEN} = 10V, R_G = 6\Omega$		11	20	ns
Rise Time	$t_r$			11	20	
Turn-Off Delay Time	$t_{d(off)}$			48	80	
Fall Time	$t_f$			15	30	
Input Capacitance	$C_{iss}$	$V_{GS} = 0V$	–	1850	–	pF
Output Capacitance	$C_{oss}$	$V_{DS} = 15V$	–	315	–	
Reverse Transfer Capacitance	$C_{rss}$	$f = 1.0MHz$	–	145	–	
Source-Drain Reverse Recovery Time	$t_{rr}$	$I_F = 25A, di/dt = 100A/\mu s$		160		ns

**Note:**

(1) Pulse test; pulse width  $\leq 300 \mu s$ , duty cycle  $\leq 2\%$

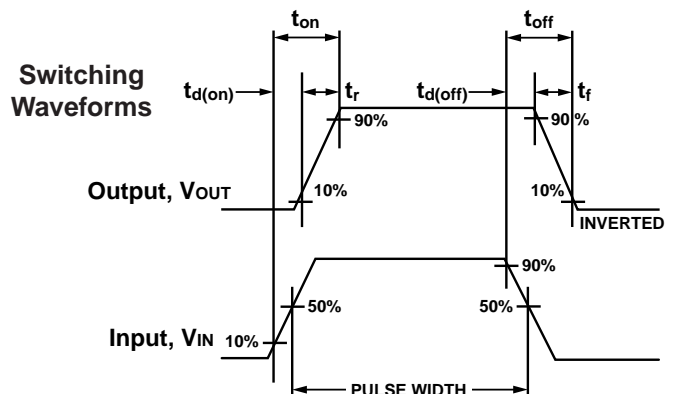
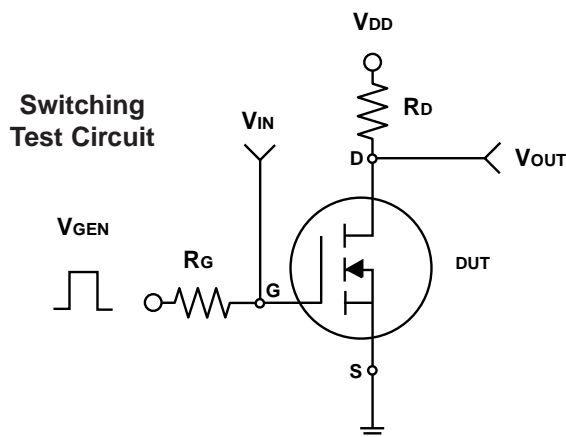

**N-Channel Enhancement-Mode MOSFET**

**Ratings and Characteristic Curves** ( $T_A = 25^\circ\text{C}$  unless otherwise noted)

**Fig. 1 – Output Characteristics**

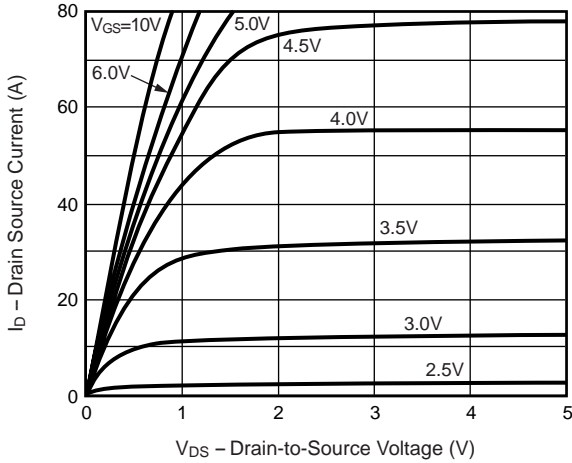

**Fig. 2 – Transfer Characteristics**

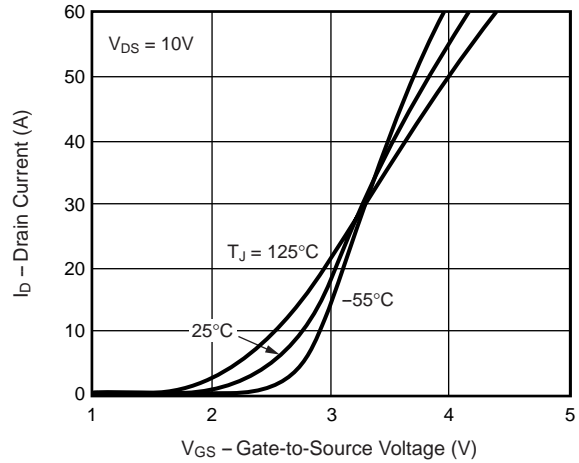

**Fig. 3 – Threshold Voltage vs. Temperature**

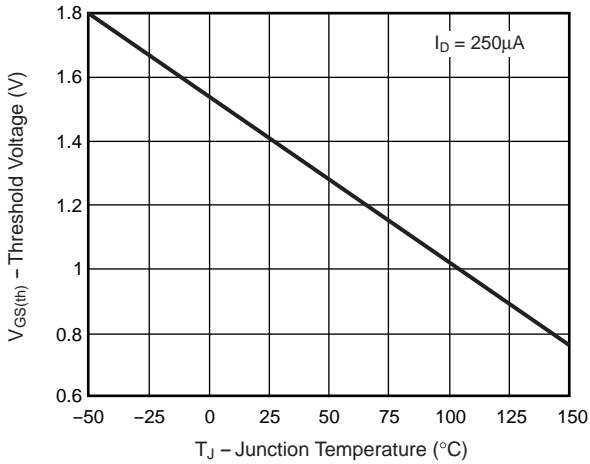

**Fig. 4 – On-Resistance vs. Drain Current**

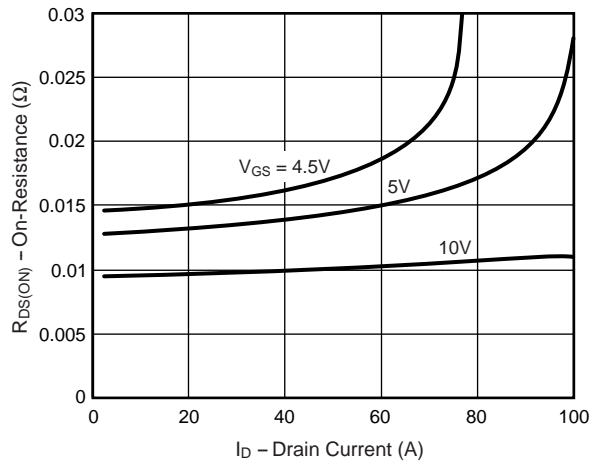

**Fig. 5 – On-Resistance vs. Junction Temperature**

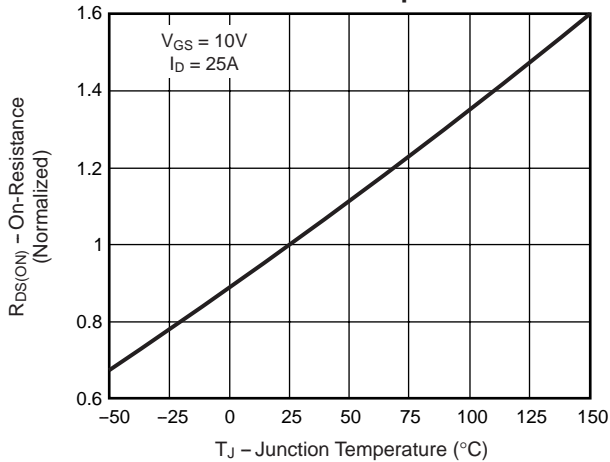

**N-Channel Enhancement-Mode MOSFET**

**Ratings and Characteristic Curves** ( $T_A = 25^\circ\text{C}$  unless otherwise noted)

**Fig. 6 – On-Resistance vs. Gate-to-Source Voltage**

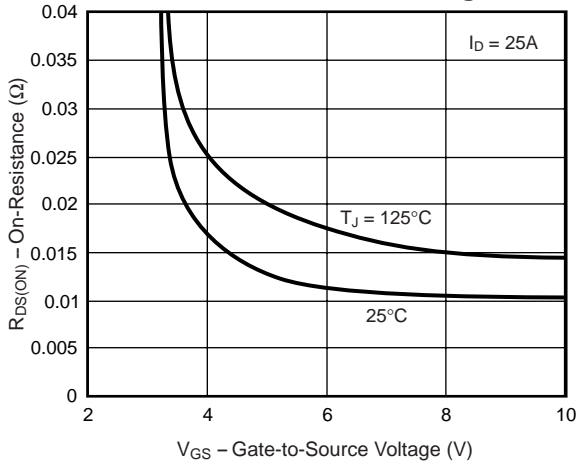

**Fig. 7 – Gate Charge**

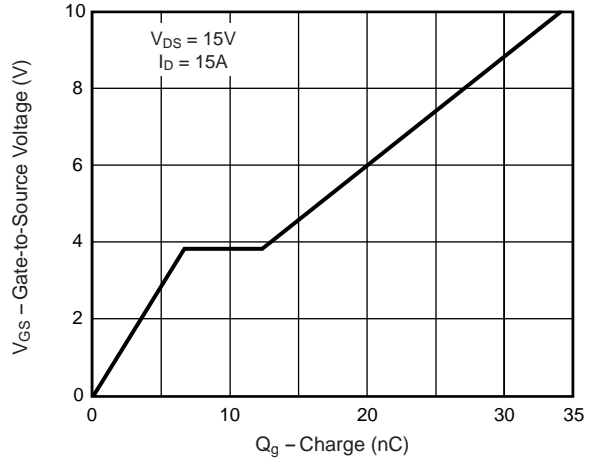

**Fig. 8 – Capacitance**

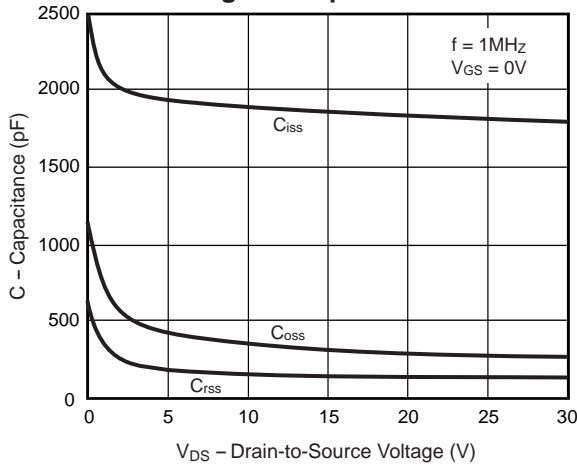

**Fig. 9 – Source-Drain Diode Forward Voltage**

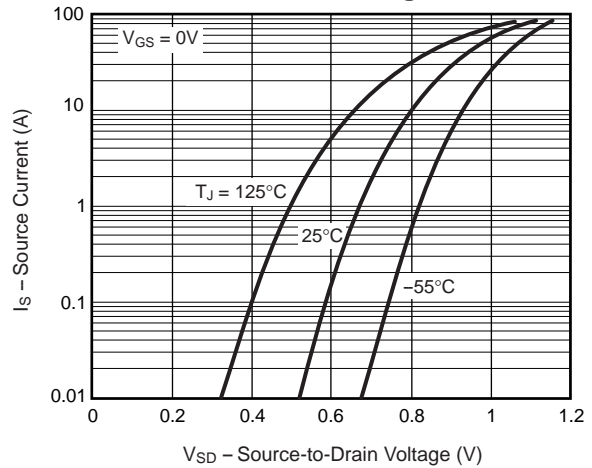

N-Channel Enhancement-Mode MOSFET

Ratings and Characteristic Curves (T<sub>A</sub> = 25°C unless otherwise noted)

Fig. 10 – Breakdown Voltage vs. Junction Temperature

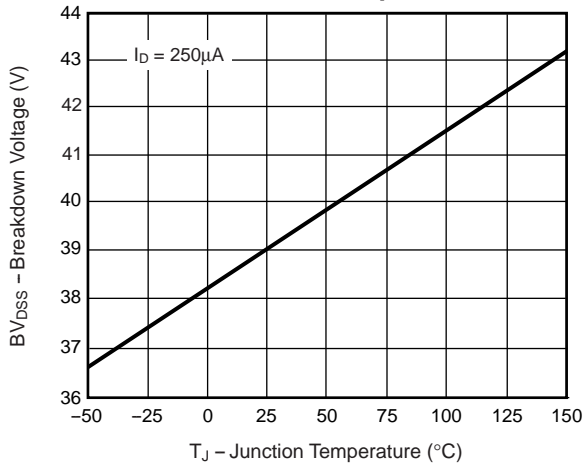

Fig. 11 – Transient Thermal Impedance

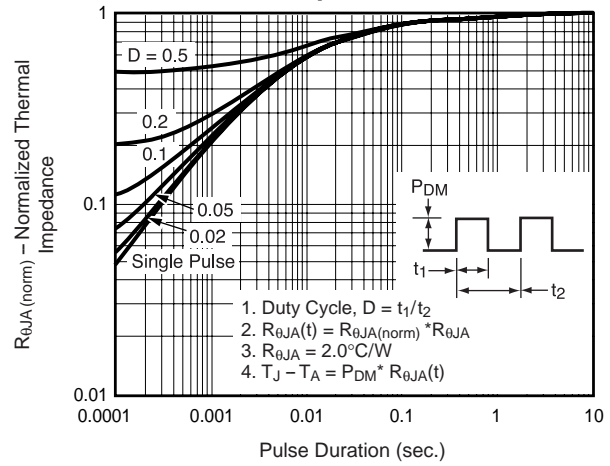

Fig. 12 – Power vs. Pulse Duration

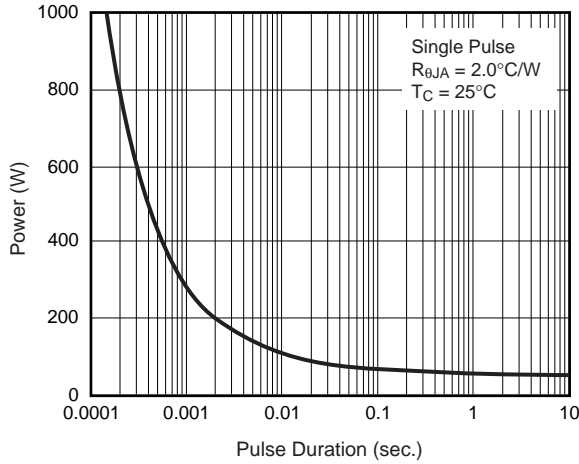

Fig. 13 – Maximum Safe Operating Area

