

N-Channel Enhancement-Mode MOSFET

V_{DS} 30V $R_{DS(ON)}$ 8mΩ I_D 70A

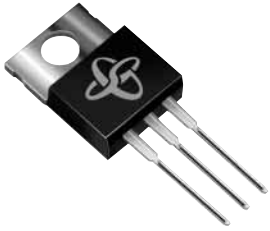

TRENCH GENFET®

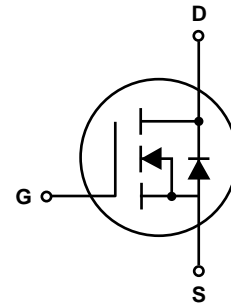

TO-220AB

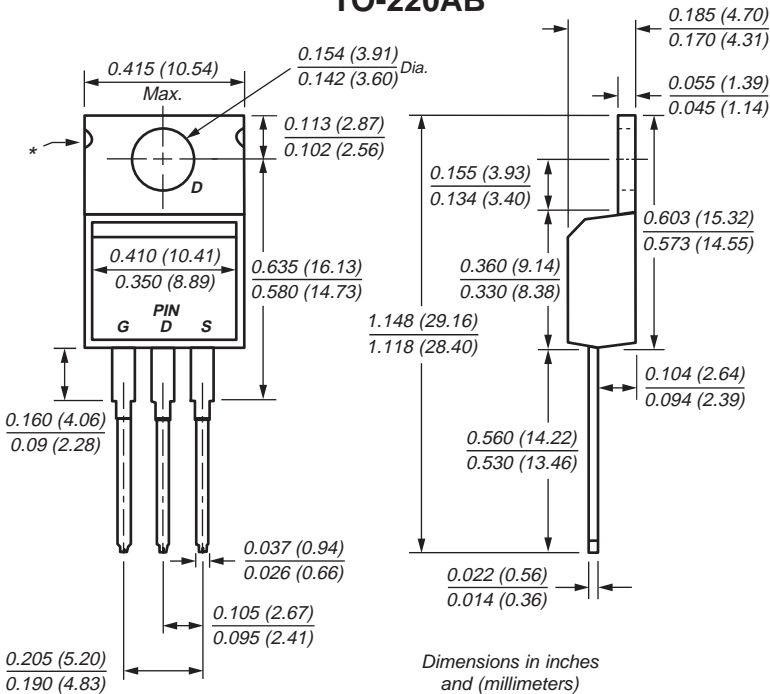

* May be notched or flat

Features

- Advanced Process Technology
- High Density Cell Design for Ultra Low On-Resistance
- Specially Designed for Low Voltage DC/DC Converters
- Fast Switching for High Efficiency

Mechanical Data

Case: JEDEC TO-220AB molded plastic body

Terminals: Leads solderable per MIL-STD-750, Method 2026

High temperature soldering guaranteed: 250°C/10 seconds, 0.17" (4.3mm) from case

Mounting Torque: 10 in-lbs maximum

Weight: 2.0g

Maximum Ratings and Thermal Characteristics ($T_C = 25^\circ\text{C}$ unless otherwise noted)

Parameter	Symbol	Limit	Unit
Drain-Source Voltage	V_{DS}	30	V
Gate-Source Voltage	V_{GS}	± 20	
Continuous Drain Current ⁽¹⁾	I_D	70	A
Pulsed Drain Current	I_{DM}	200	
Maximum Power Dissipation	P_D	$T_C = 25^\circ\text{C}$ 62.5	W
		$T_C = 100^\circ\text{C}$ 25	
Operating Junction and Storage Temperature Range	T_J, T_{stg}	-55 to 150	$^\circ\text{C}$
Lead Temperature (1/8" from case for 5 sec.)	T_L	275	$^\circ\text{C}$
Junction-to-Case Thermal Resistance	$R_{\theta JC}$	2.0	$^\circ\text{C/W}$
Junction-to-Ambient Thermal Resistance	$R_{\theta JA}$	62.5	$^\circ\text{C/W}$

Notes: (1) Maximum DC current limited by the package

N-Channel Enhancement-Mode MOSFET

Electrical Characteristics (T_J = 25°C unless otherwise noted)

Parameter	Symbol	Test Condition	Min	Typ	Max	Unit
Static						
Drain-Source Breakdown Voltage	BV _{DSS}	V _{GS} = 0V, I _D = 250μA	30	—	—	V
Gate Threshold Voltage	V _{GS(th)}	V _{DS} = V _{GS} , I _D = 250μA	1.0	—	3.0	V
Gate-Body Leakage	I _{GSS}	V _{DS} = 0V, V _{GS} = ±20V	—	—	±100	nA
Zero Gate Voltage Drain Current	I _{DSS}	V _{DS} = 30V, V _{GS} = 0V	—	—	1	μA
On-State Drain Current ⁽²⁾	I _{D(on)}	V _{DS} ≥ 5V, V _{GS} = 10V	70	—	—	A
Drain-Source On-State Resistance ⁽²⁾	R _{DSON}	V _{GS} = 10V, I _D = 35A	—	6	8	mΩ
		V _{GS} = 4.5V, I _D = 30A	—	9	11	
Forward Transconductance ⁽²⁾	g _{fs}	V _{DS} = 15V, I _D = 35A	—	61	—	S
Dynamic						
Total Gate Charge	Q _g	V _{DS} = 15V, V _{GS} = 5V, I _D = 35A	—	34	48	nC
			—	63	95	
			—	11	—	
Gate-Source Charge	Q _{gs}	V _{DS} = 15V, V _{GS} = 10V I _D = 35A	—	11	—	nC
Gate-Drain Charge	Q _{gd}		—	11	—	
Turn-On Delay Time	t _{d(on)}	V _{DD} = 15V, R _L = 15Ω I _D ≅ 1A, V _{GEN} = 10V R _G = 6Ω	—	9	14	ns
Rise Time	t _r		—	9	14	
Turn-Off Delay Time	t _{d(off)}		—	100	167	
Fall Time	t _f		—	31	62	
Input Capacitance	C _{iss}	V _{GS} = 0V V _{DS} = 15V f = 1.0MHz	—	3400	—	pF
Output Capacitance	C _{oss}		—	618	—	
Reverse Transfer Capacitance	C _{rss}		—	300	—	
Source-Drain Diode						
Max Diode Forward Current	I _S	—	—	—	35	A
Diode Forward Voltage ⁽²⁾	V _{SD}	I _S = 35A, V _{GS} = 0V	—	0.9	1.3	V

Notes:

(1) Maximum DC current limited by the package

(2) Pulse test; pulse width ≤ 300 μs, duty cycle ≤ 2%

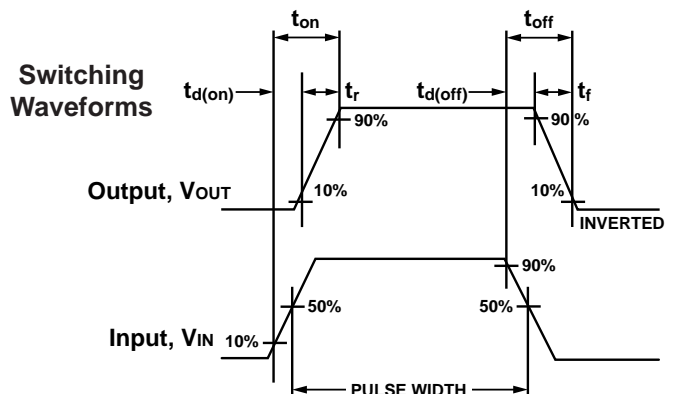
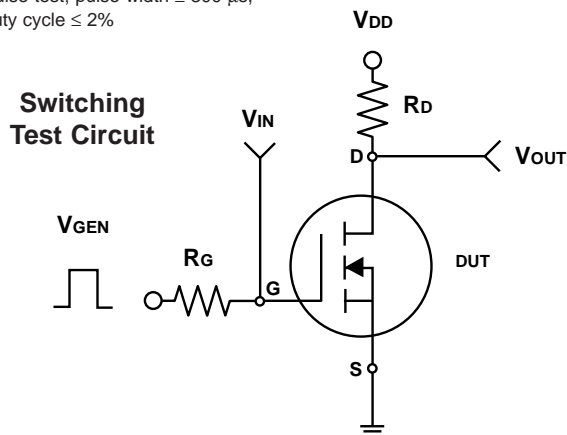

N-Channel Enhancement-Mode MOSFET

Ratings and Characteristic Curves (T_A = 25°C unless otherwise noted)

Fig. 1 – Output Characteristics

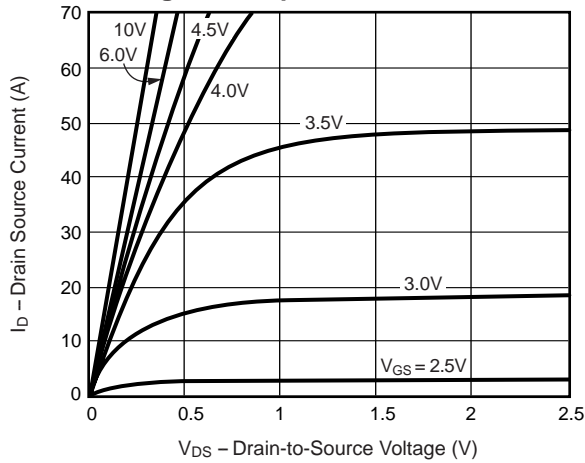

Fig. 2 – Transfer Characteristics

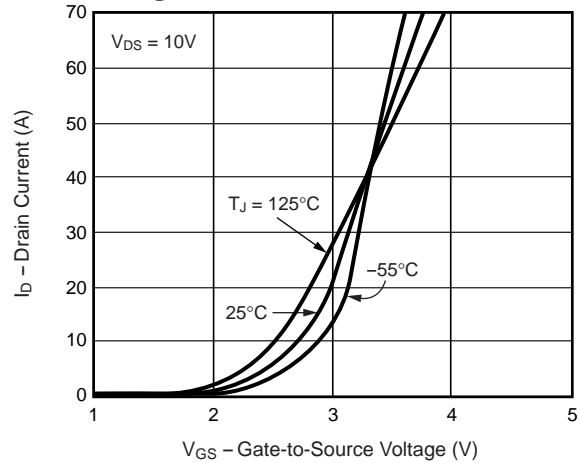

Fig. 3 – Threshold Voltage vs. Temperature

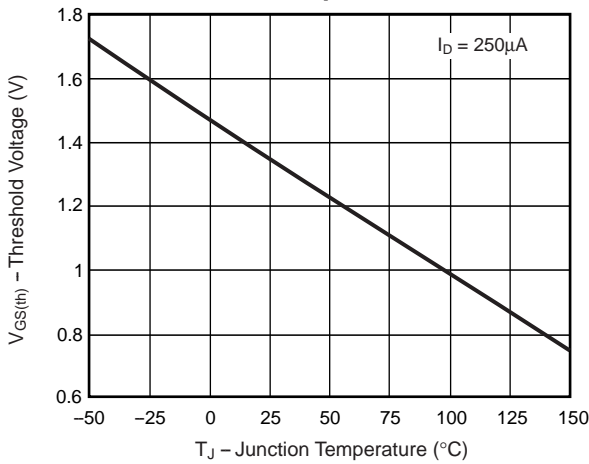

Fig. 4 – On-Resistance vs. Drain Current

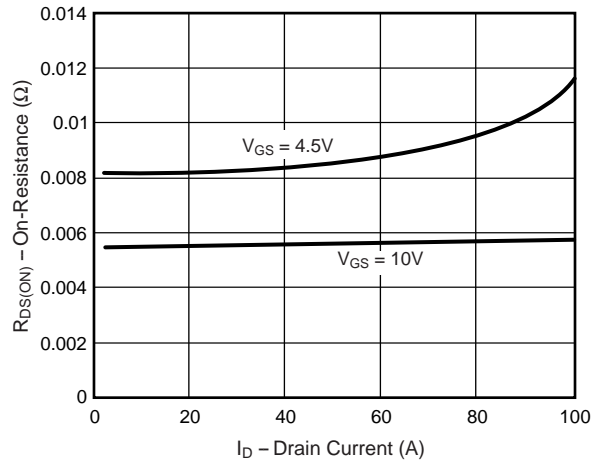
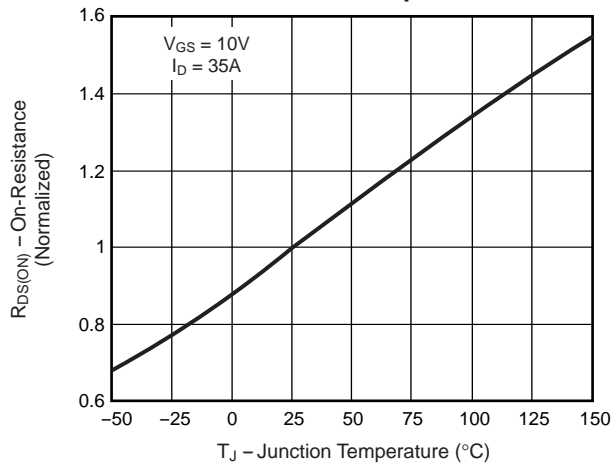

Fig. 5 – On-Resistance vs. Junction Temperature



N-Channel Enhancement-Mode MOSFET

Ratings and Characteristic Curves ($T_A = 25^\circ\text{C}$ unless otherwise noted)

Fig. 6 – On-Resistance vs. Gate-to-Source Voltage

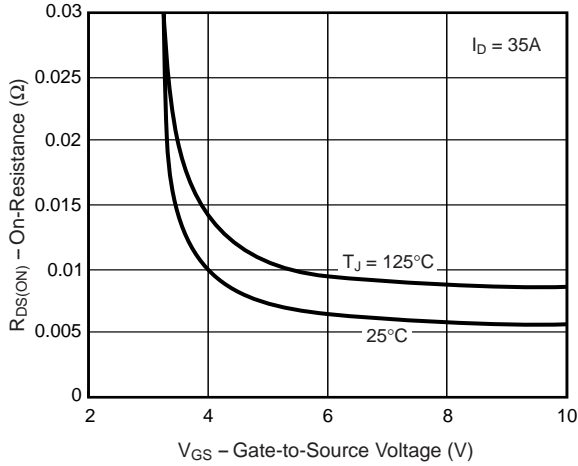

Fig. 7 – Gate Charge

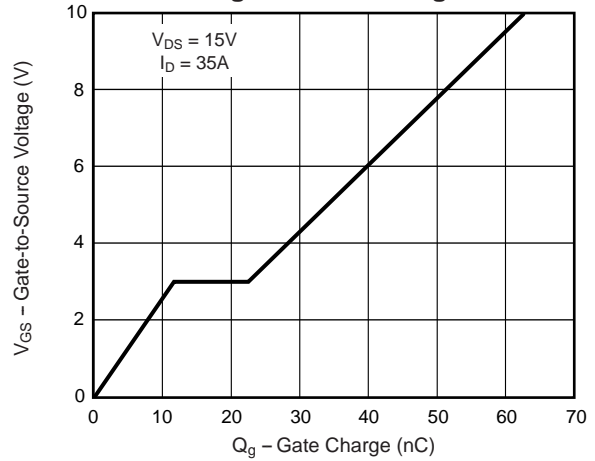

Fig. 8 – Capacitance

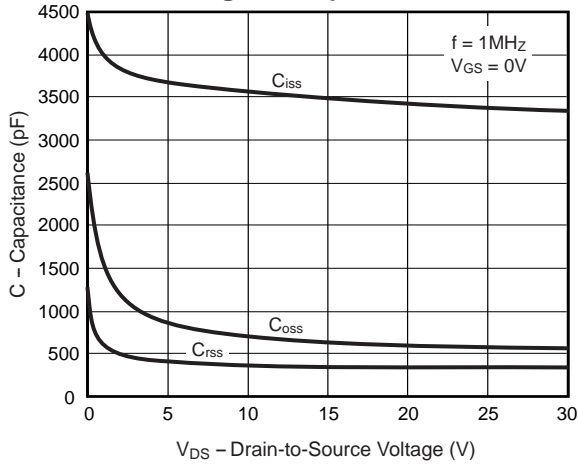
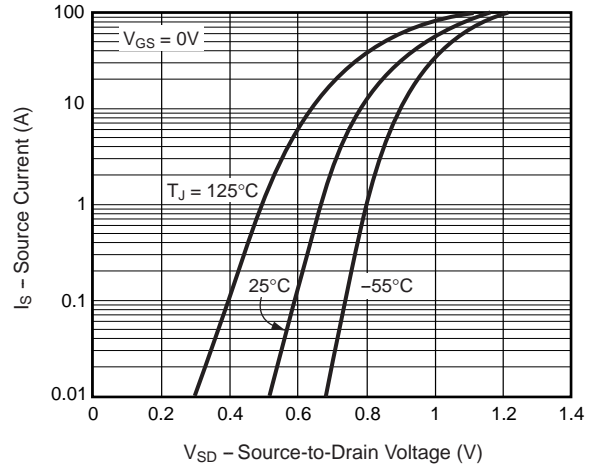

Fig. 9 – Source-Drain Diode Forward Voltage



N-Channel Enhancement-Mode MOSFET

Ratings and Characteristic Curves ($T_A = 25^\circ\text{C}$ unless otherwise noted)

Fig. 10 – Breakdown Voltage vs. Junction Temperature

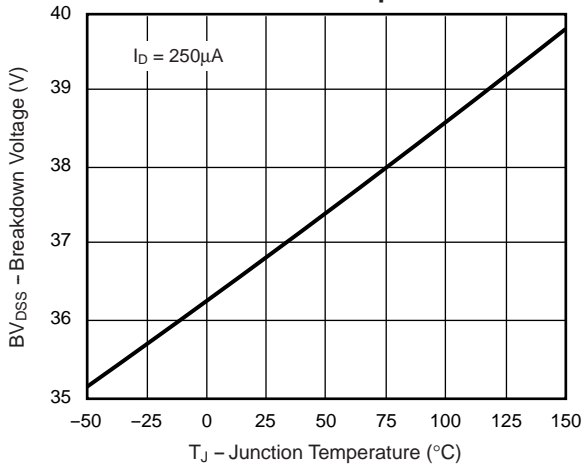

Fig. 11 – Thermal Impedance

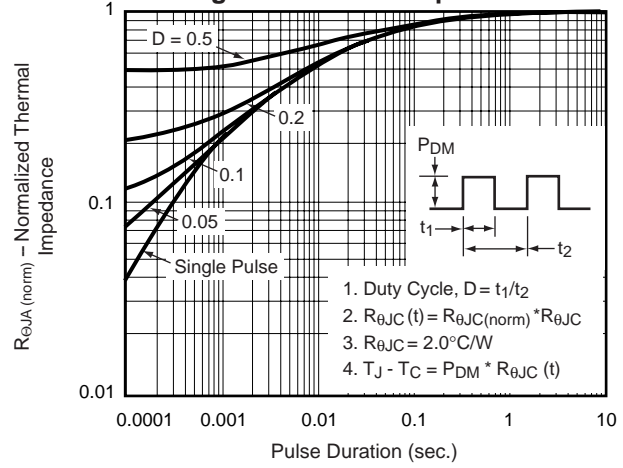

Fig. 12 – Power vs. Pulse Duration

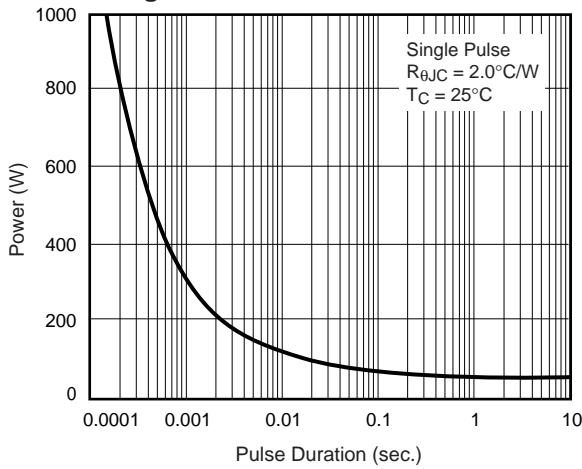

Fig. 13 – Maximum Safe Operating Area

