

TO : customers

DATE : 2005.03.22

D.C.D. Display Solution srl
Via Timermans, 6 Torino ITALY
w w w . d c d . i t
TEL.:+39 - 011 - 7731830
FAX: +39 011-7728663

DOCUMENTATION FOR APPROVAL

PRODUCT : CCFL BACKLIGHT INVERTER(RoHS)

MODEL NAME : GH027I

GCCT NAME : GCCT027AE

APPROVAL	CHECKED	WRITTEN

PLEASE RETURN ONE DOCUMENT AFTER APPROVED SIGN.

GREEN C&C TECH	INVERTER SPECIFICATION (GH027I)	R&D DATE : 2005.08.05
----------------	--------------------------------------	--------------------------

NO	DATE	REVISION	PAGE
1	2005.06.15	Change the part: R10,11,14,15 : 150Ω→47Ω AP4532GM(APEC)→AP4509GM(APEC) Add the vendor AO4606(AOS) Remove the vendor SP8M3(ROHM)	1,6
2	2005.09.12	Change the operating temperature 0~50℃ → -10~60℃	1,2
REVISION HISTORY			

REV.											
Page											
REV.	0										
Page	12										
REV.	2	1	0	0	0	1	0	0	0	0	0
Page	1	2	3	4	5	6	7	8	9	10	11

GREEN C&C TECH	INVERTER SPECIFICATION (GH027I)	R&D DATE : 2005.03.22
----------------	--------------------------------------	--------------------------

1. APPLICATION

This Document Specified The Detailed Product Requirements of Inverter
GH027I

2. SUITABLE LOAD

LCD MODULE : 15" 4LAMP TFT LCD

3. ELECTRICAL CHARACTERISTICS

3-1. Absolute Maximum Ratings

ITEM	SYMBOL	SPEC	UNIT	REMARKS
INPUT VOLTAGE1	Vin1	11.0 ~ 13.0V	V	
INPUT VOLTAGE2	Vin2	4.9~5.1	V	
OPERATING TEMPERATURE	Top	-10~60	℃	
STORAGE TEMPERATURE	Tstg	-30~80	℃	
RELATIVE HUMIDITY	RH	90	%	

3-2. Control Signal

PIN NO.	SYMBOL	STATUS	ACTION	REMARKS
CN1 #4	BKLT_ON	HIGH	LAMP(CCFL)-ON	2.4~5.25V
		LOW	LAMP(CCFL)-OFF	0.8V MAX

GREEN C&C TECH	INVERTER SPECIFICATION (GH0271)	R&D DATE : 2005.03.22
----------------	---	--------------------------

3-3. Output Characteristics

ITEM	SYMBOL	CONDITION			SPECIFICATION			UNIT
		Vin1(V) (DC-IN)	BRT- ADJ	RL1,2(k Ω) RL3,4(k Ω)	MIN	TYP	MAX	
OUTPUT CURRENT	Io1,2(max)	12	0V	100 \pm 0.5	5.7	6.2	6.7	mArms
	Io1,2(min)	12	3.5V	100 \pm 0.5	2.7	3.2	3.7	
	Io3,4(max)	12	0V	100 \pm 0.5	5.7	6.2	6.7	
	Io3,4(min)	12	3.5V	100 \pm 0.5	2.5	3.0	3.5	
INPUT CURRENT	Iin(1)	12	0V	100 \pm 0.5	1.3	1.7	2.1	ADC
FREQUENCY	F(1)	12	0V	100 \pm 0.5	50	55	60	KHz
FREQUENCY	F(2)	12	0V	100 \pm 0.5	50	55	60	KHz

3.4 Test Circuit

-SW1 : A→BL ON
B→BL OFF

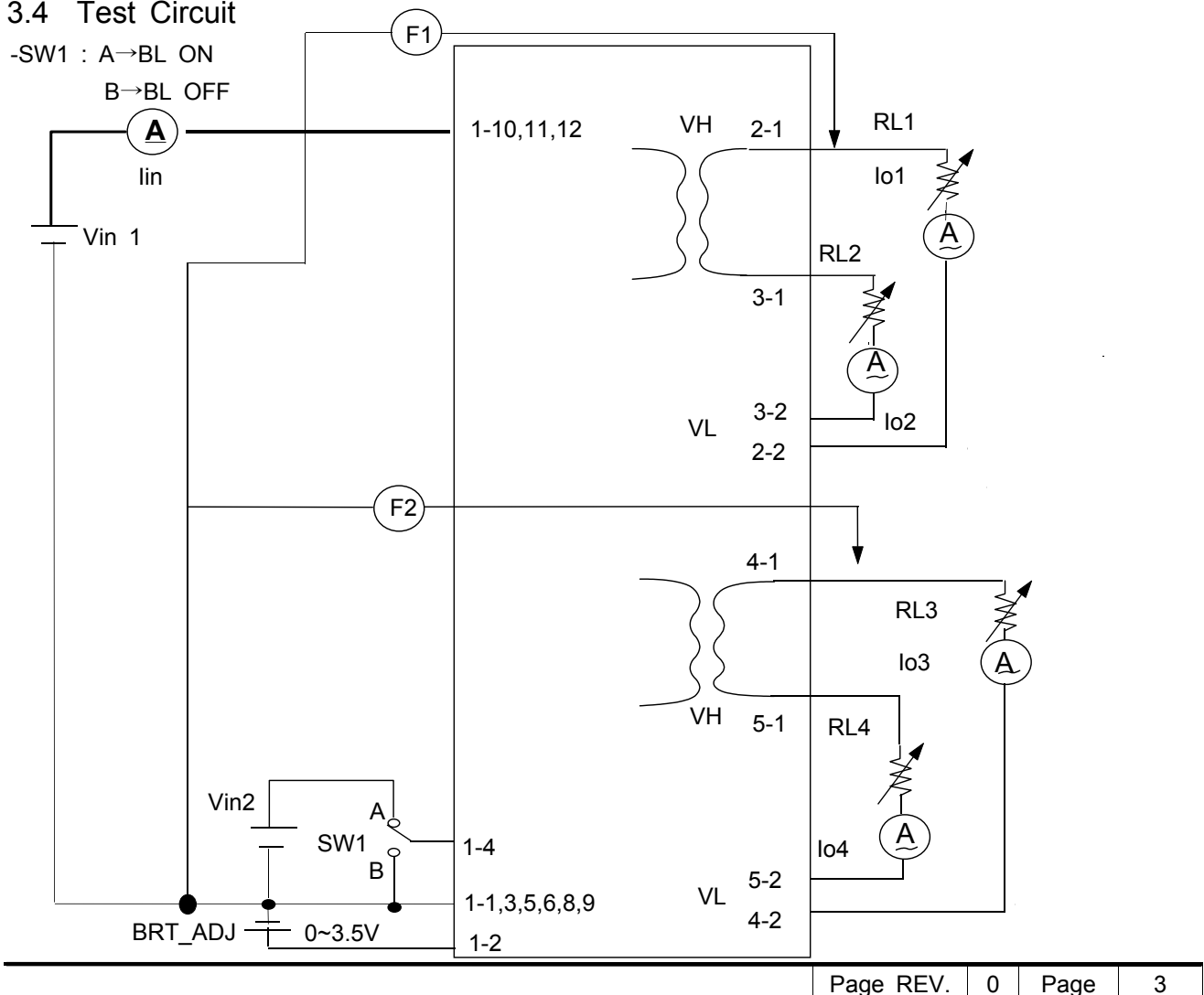

GREEN C&C TECH	INVERTER SPECIFICATION (GH027I)	R&D DATE : 2005.03.22
----------------	--------------------------------------	--------------------------

4. INTERFACE

4.1 CN1 CONNECTOR : 53261-1290 or Equivalent

PIN NO	SYMBOL	REMARK
2	BRT_ADJ	0 ~ 3.5V
1,3,5,6,8,9	GND	GND
4	BL ON/OFF	CCFL Drive SIGNAL(Active HIGHT)
7	N.C	
10,11,12	DC-IN(Vin)	DC INPUT Power (12V)

4.2 CN2 CONNECTOR : SM02B-BHSS-1-TB(JST) or Equivalent

PIN NO.	SYMBOL	REMARK
1	HOT	HIGH
2	COLD	LOW

4.3 CN3 CONNECTOR : SM02B-BHSS-1-TB(JST) or Equivalent

PIN NO.	SYMBOL	REMARK
1	HOT	HIGH
2	COLD	LOW

4.4 CN4 CONNECTOR : SM02B-BHSS-1-TB(JST) or Equivalent

PIN NO.	SYMBOL	REMARK
1	HOT	HIGH
2	COLD	LOW

4.5 CN5 CONNECTOR : SM02B-BHSS-1-TB(JST) or Equivalent

PIN NO.	SYMBOL	REMARK
1	HOT	HIGH
2	COLD	LOW

4.6 CN4 CONNECTOR : SM02B-BHSS-1-TB(JST) or Equivalent

PIN NO.	SYMBOL	REMARK
1	HOT	HIGH
2	COLD	LOW

GREEN C&C TECH	INVERTER SPECIFICATION (GH027I)	R&D DATE : 2005.08.05
----------------	------------------------------------	--------------------------

5. APPEARANCE (UNIT : mm)

(TOLERANCE: ±0.2mm)

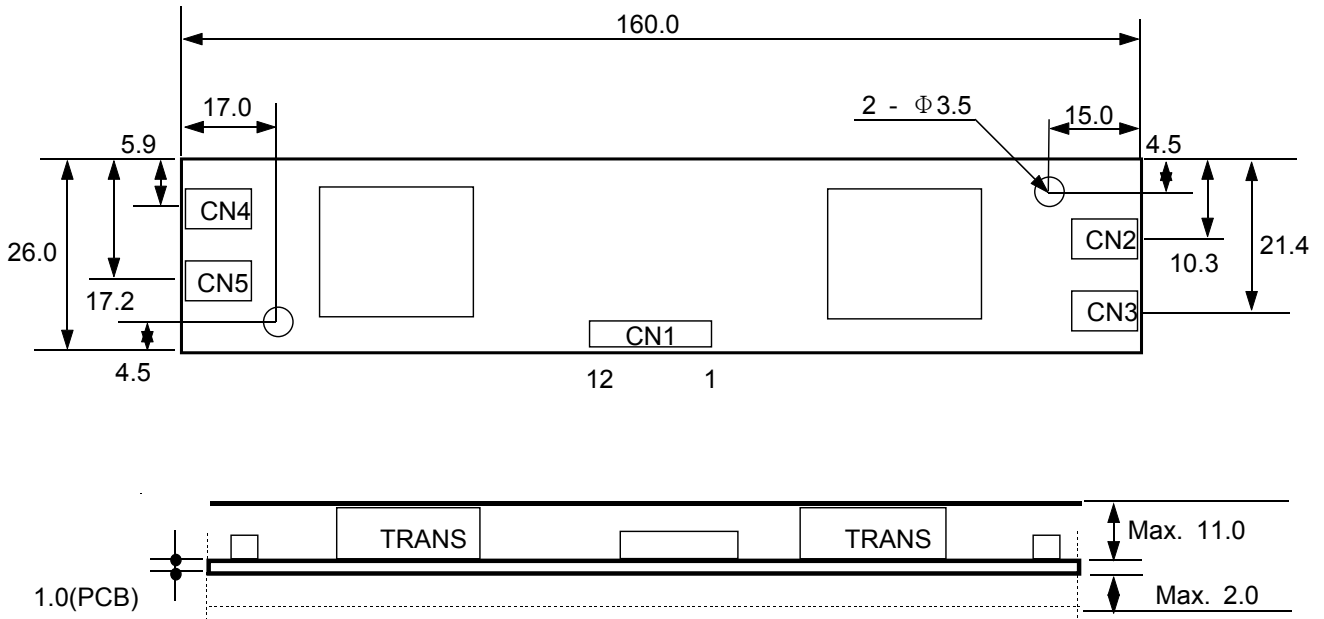

6. NOTATION OF LOT NUMBER

MARKING : BOTTOM OF PCB.

GH027I
YYWWMMM

GH027I : MODEL NAME
 YY : YEAR OF PRODUCT '00,'01,...,'98,'99
 WW : WEEK OF PRODUCT 01,02,03,04,...53
 MMMM : SERIAL NUMBER 0001,0002.....9998,9999

GREEN C&C TECH	INVERTER SPECIFICATION (GH0271)	R&D DATE : 2005.06.15
----------------	--------------------------------------	--------------------------

7.PART LIST

SYMBOL	NAME	1st		2nd	
		TYPE NO	MAKER	TYPE NO	MAKER
U1	IC	BD9883	ROHM		
U2,3	FET	AP4509M	APEC	AO4606	AOS
		FDS8958A	F.C	AP4503GM	APEC
Q3,4	TR	SST2222A	ROHM	MMBT2222A	DIODES
		SBT2222A	AUK		
Q1	TR	SST2907A	ROHM	MMBT2907A	DIODES
		SBT2907A	AUK		
D2,3,4,5	DIODE	1SS355	ROHM	1N4148WS	DIODES
D1,6	DIODE	BAV99	DIODES	DAN217	ROHM
		SDS7000F	AUK	1SS379	TOSHIBA
ZD1,2	ZENER	UDZ5.6B	ROHM	UDZ5V6B	DIODES
C1,C2	C-ELEC	220uF/25V NXB Series	SAMYOUNG	220uF/25V WB Series	SAMHWA
C13	MLCC	CL32F106Z	SEMCO	EQUIVALENT	
C6	"	CL10B103K	"	"	
C5	"	CL10C561J	"	"	
C9,12	"	CL10B473K	"	"	
C8	"	CL10B333K	"	"	
C10,11	"	CL10F105Z	"	"	
C3	"	CL10C221J	"	"	
C7	"	CL10F224Z	"	"	
C4	"	CL10B222K	"	"	
R1	CHIP-R	RC1608J273	"	"	
R3	"	RC1608J364	"	"	
R4	"	RC1608J124	"	"	
R5	"	RC1608J333	"	"	
R6	"	RC1608J623	"	"	
R7	"	RC1608J272	"	"	
R8	"	RC1608J102	"	"	
R9,13,18	"	RC1608J103	"	"	
R10,11,14,15	"	RC1608J470	"	"	
R16,17,21,22	"	RC1608J911	"	"	
R23	"	RC1608J104	"	"	
R19,20		RC1608J684			

GREEN C&C TECH	INVERTER SPECIFICATION (GH027I)	R&D DATE : 2005.03.22
----------------	--	--------------------------

SYMBOL	NAME	1st		2nd	
		TYPE NO	MAKER	TYPE NO	MAKER
T1,2	TRANS	°GT-209	NAMYANG	°GT-209	DONGHEUNG
		°GT-209	JINYOUNG	°GT-209	SEJIN
		°GT-209	TRANSTEK		
F1	FUSE	KE32	DAITO	BA100 3A	SAVEFUSE
		F1206FA3000V032T	AEM INC		
CN1	CONNECTOR	53261-1290	MOLEX	12050WR-12A	YEONHO
CN2,3,4,5	"	SM02B-BHSS	JST	35001WR-02	YEONHO
PCB	PCB	GH027A REV5.0	WONKYENG	GH027A REV5.0	SOOJOO
		GH027A REV5.0	YOUNG EUN	GH053A REV5.0	FINE CIRCUIT

GREEN C&C TECH	INVERTER SPECIFICATION (GH0271)	R&D DATE : 2005.08.05
----------------	--------------------------------------	--------------------------

8. PCB LAYOUT

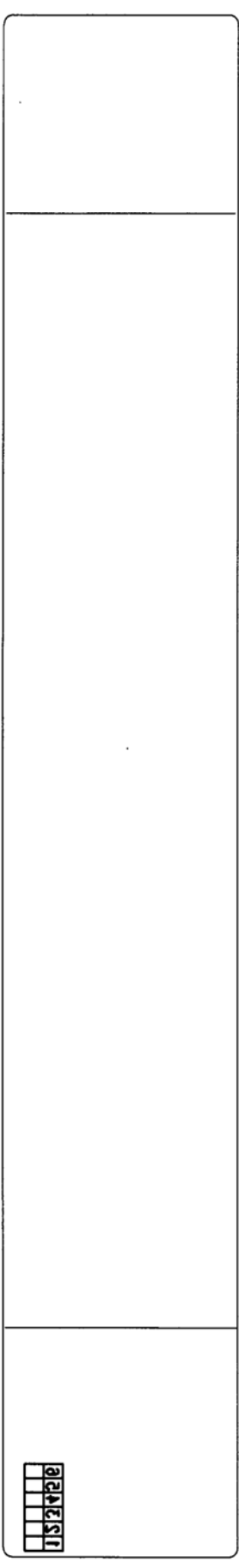
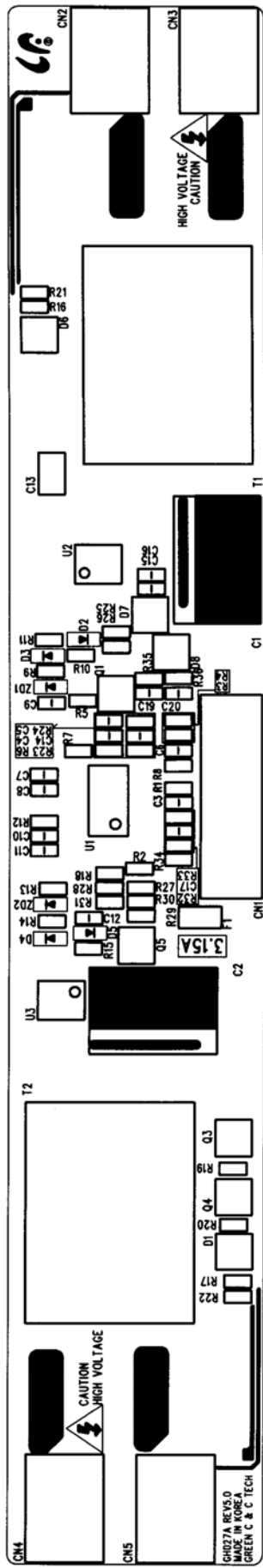
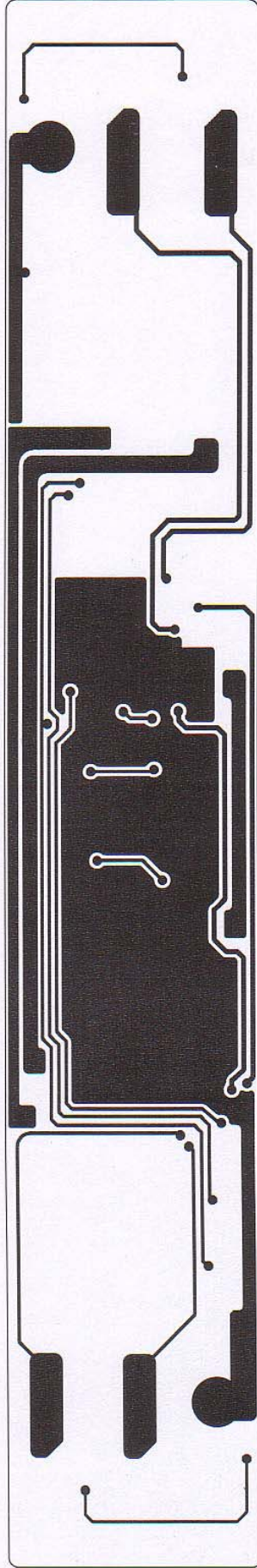
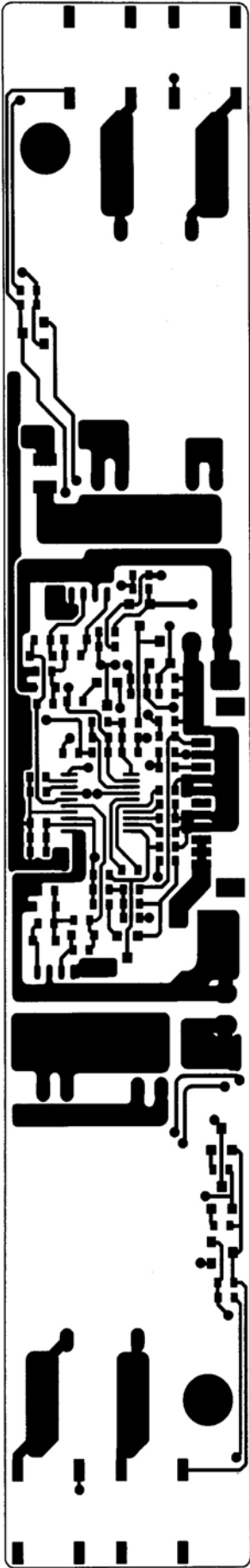

11531210

GREEN C&C TECH	INVERTER SPECIFICATION (GH0271)	R&D DATE : 2005.03.22
----------------	--------------------------------------	--------------------------

9. CIRCUIT

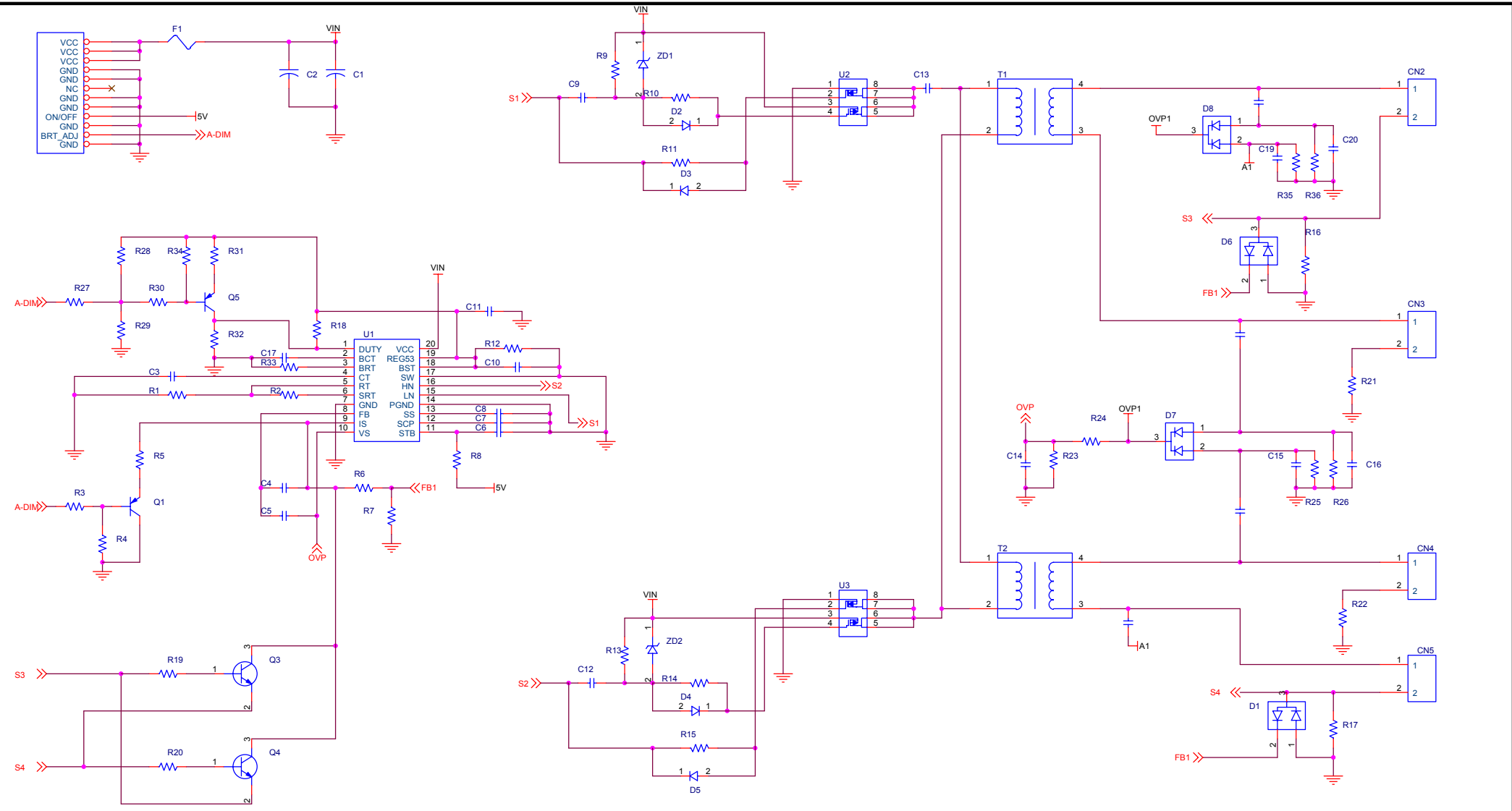

GREEN C&C TECH		
Title: GH0271 REV5.0		
Size: A3	Document Number: GCCT027AE	Rev: 5.0
Date: Wednesday, March 16, 2005	Sheet: 1	of 1

GREEN C&C TECH	INVERTER SPECIFICATION (GH0271)	R&D DATE : 2005.03.22
----------------	--------------------------------------	--------------------------

10.FLOW CHART

MODEL (TYPE)	GH0271	REVISION	5
WRITER	H.W.KIM	(FLOW CHART)	
FLOW CHART	PROCESS	EQUIPMENTS	REFERENCES
	Raw Material		PART LIST
	Cream-solder Printing of F-side	Cream-solder Printer	
	Discrete Device Assembly	Low-High Mounter	
	Reflow Soldering	Reflower	
	Visual Inspection	Microscope	
	Preparing Process		
	Soldering By Hand for Discrete Components		
	Visual Inspection		
	PCB Division	Silicon Dispenser	
	Aging	Power Supply, Aging Box	2h
	Electrical Characteristic Inspection	Testing SYSTEM, Testing JIG	
	Insulator & LABEL		
	Attachment Package		
	Outgoing Inspection	Testing SYSTEM, Testing JIG	List of Inspection
	Shipping		
Based on standard rule	GCCT027AE		

GREEN C&C TECH	INVERTER SPECIFICATION (GH027I)	R&D DATE : 2005.03.22
----------------	--------------------------------------	--------------------------

11. RELIABILITY TEST SPEC

NO.	ITEM	CONDITIONS AND METHOD
1	High Temperature Storage Test	Temp : 70℃ Duration 500hrs
2	Low Temperature Storage Test	Temp : -30℃ Duration 500hrs
3	High Temperature High Humidity Storage	Temp : 40℃ Humid 95%RH Duration 500hrs
4	High Temperature High Humidity Operation test	Temp : 40℃ Humid 95%RH Duration 1000hrs
5	Thermal Shock Test	Temp -30℃ ↔ 70℃,250cycle (30min) (30min)
6	Vibration test	Amplitude :1.5mm Frequency :10~55Hz Position : three perpendicular planes Duration 1000hrs
7	High Temperature Operation test	Temp : 50℃ Duration 72hrs
8	Low Temperature Operation test	Temp : 0℃ Duration 72hrs

GREEN C&C TECH	INVERTER SPECIFICATION (GH027I)	R&D DATE : 2005.03.22
----------------	--------------------------------------	--------------------------

12. PACKING
12.1 BOX

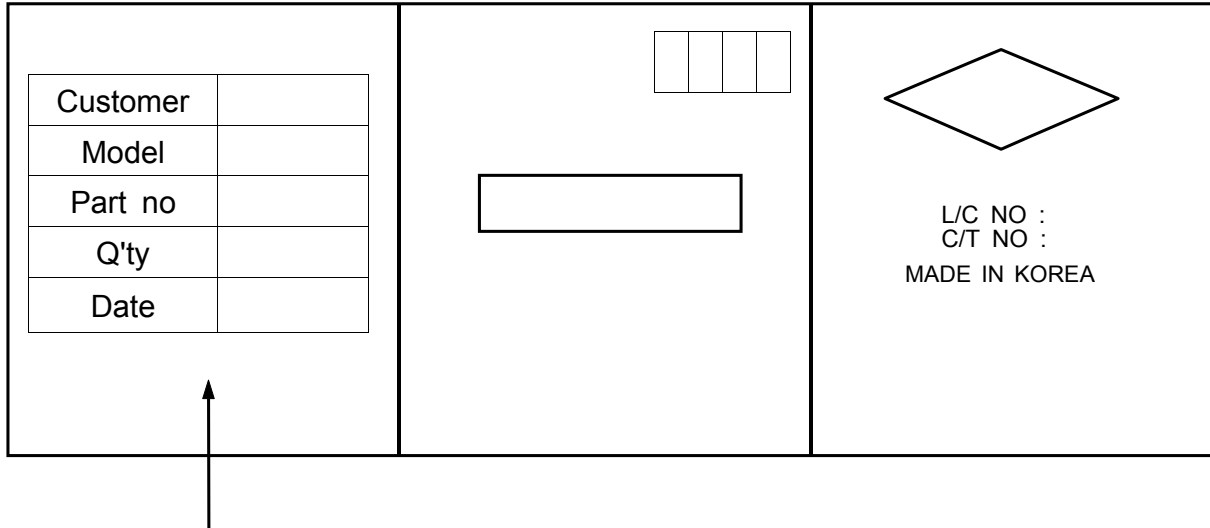

Customer	
Model	GH027I
Part no	
Q'ty	000 EA
Date	00.00.00

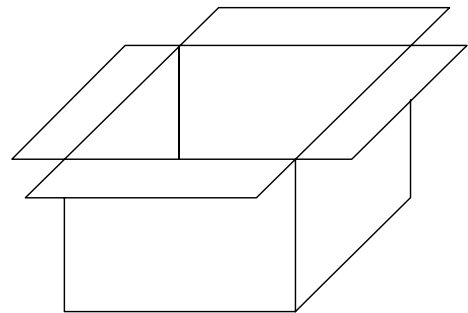

12.2 TRAY

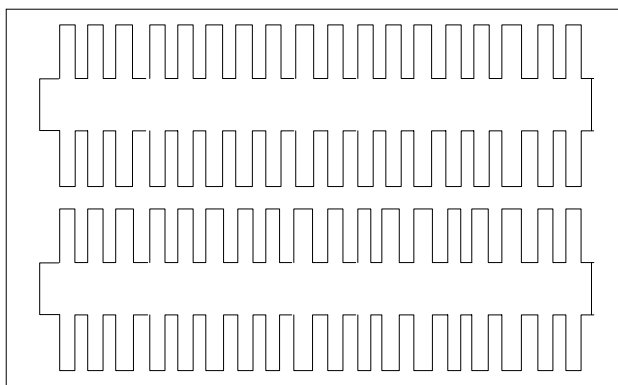

1 TRAY : 36EA
1 BOX : 9TRAY (324EA)

SYMBOL	TYPE NO
PACKING-TRAY	383*319*36
PACKING-BOX	393*324*358
PACKING-PAD	393*324*3

1. MATERIAL LIST FOR SAFETY GH027I

1.1 LIST

SYMBOL	NAME	TYPE NO.	MANUFACURER	DESCRIPTION
F1	FUSE	KE32	DAITO COMMUNICATION APPARATUS CO LTD	UL FILE NO. E59783
		F1206FA4000V032T	aem inc	UL NO : E232989
		BA100(3A)	SAVEFUSE	UL file NO. E146895 CSA file No. LR98127
PCB	PRINTED WIRING BOARD	FR-4	SOOJOO	UL FILE NO :E173459
			YOUNG EUN	UL FILE NO : E173507
			WONKYENG	UL FILE NO :E202541
			FINE CIRCUIT	UL FILE NO :E129799
CN1	CONNECTOR	12505WR-12A00	YEONHO	UL:E108706
		53261-1290	MOLEX	UL FILE NO:E29179 NYLON 66 UL94V-0
CN2,3,4,5	CONNECTOR	35001WR-02	YEONHO	UL:E108706
		SM02B-BHSS	JST	UL FILE NO : E60389 POLYAMIDE RESIN UL94V-0
T1,T2	TRANSFORMER	°GT-209	NAMYANG ELECTRONICS	CLASS A (105 de.C) SEE TRANS SPEC
			JIN YOUNG ELECTRONICS	CLASS A (105 de.C) SEE TRANS SPEC
			SEJIN	CLASS A (105 de.C) SEE TRANS SPEC
			DONG HEUNG	CLASS A (105 de.C) SEE TRANS SPEC
			TRANSTEK	CLASS A (105 de.C) SEE TRANS SPEC

CUSTOMER : GREEN C&C CO., LTD.

<h1>SPECIFICATION</h1>		SHEET NO.	
		D A T E	2005. 07. 05.
ITEM	INVERTER TRANS	MODEL NAME	
PART NO.	0 GT-209	DESCRIPTION	EFD18x20 (EEA17.7mm)

1. GENERAL SPECIFICATION

1) SCOPE

This specification applies to part number 0 GT-209 INVERTER TRANS for use in color TV and Monitor with is supplied for GREEN C&C CO., LTD.

2. GENERAL PREFERENCE

The reinspection & reapproval is required to change the structure, quality, progress of this Specification.

3. ABSOLUTE REGULARITY

- 1) Keep Temperature : -25℃ ~ 85℃
- 2) Keep Humidity : 20% ~ 95%
- 3) Use Temperature : -10℃ ~ 70℃
- 4) Use Humidity : 20% ~ 85%

4. MECHANICAL CHARACTERISTIC

1) TERMINAL TENSION INTENSITY

After fix the body, The Terminal Shall withstand for 30 seconds without losing when a static load of 1.0Kg is applied to drawing direction of the Terminal.

2) TERMINAL BEND INTENSITY

The Terminal shall withstand without breakage and bend when it returns after bend 1 time to the left side and 1 time right side with a static load.

3) VIBRATION TEST

After fix a body of the vibration board, The terminal shall withstand without losing and bend when it operates vibration test of 3 directions(X,Y,Z) for 2hours.



5. ELECTRICAL CHARACTERISTIC

1) INSULATION RESISTANCE

- ① Primary COIL TO CORE : Shall be more than
- ② Primary COIL to Secondary COIL : Shall be more than
- ③ Secondary COIL TO CORE : SHALL be more than 100MΩ when measured with DC 500V

2) WITHSTAND VOLTAGE

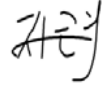
- ① Primary COIL to Secondary COIL : Shall be no damage when measured AC1.5KV, 5mA for 1 Min.
- ② P COIL TO CORE : SHALL be no damage when measured AC1.5KV, 5mA for 1 Min.
- ③ S COIL TO CORE : SHALL be no damage when measured AC1.5KV, 5mA for 1 Min.

NO	REVISION	DATE	CHECK	DRAWN	CHECKED	APPROVED
1						
2						
3						
4						

<h1>SPECIFICATION</h1>		SHEET NO.	
		D A T E	2005. 07. 05.
ITEM	INVERTER TRANS	MODEL NAME	
PART NO.	O GT-209	DESCRIPTION	EFD18x20 (EEA17.7mm)

6. APPEARANCE & DIMENSION (UNIT:mm)

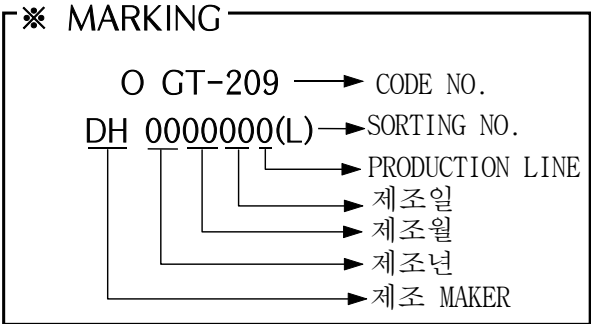
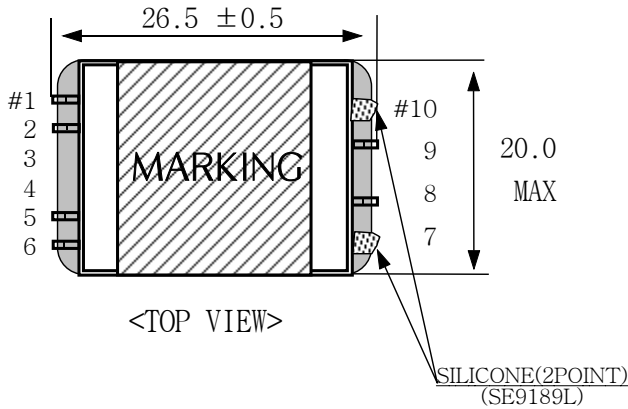

※ PRIMARY INDUCTANCE SORTING

- L : 450 uH ~ 550 uH
- N : 550 uH ~ 700 uH
- H : 700 uH ~ 800 uH

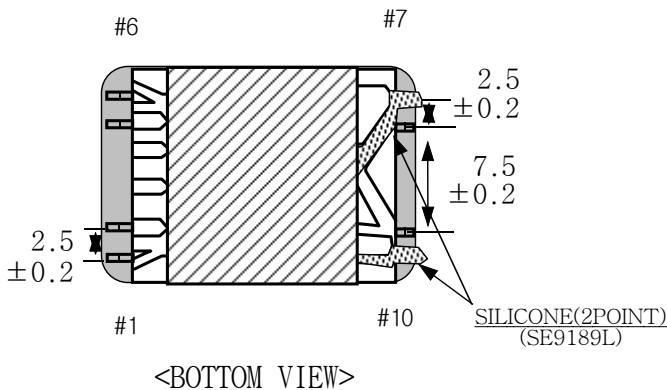
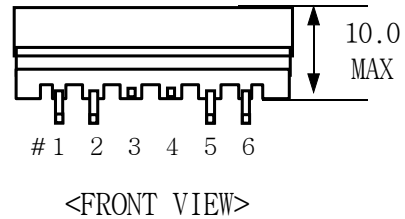
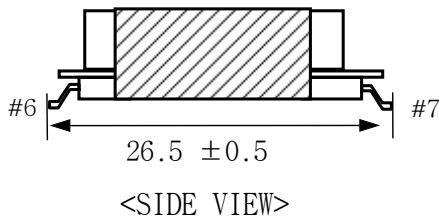

※ PRODUCTION LINE

- A : CHUN AN
- K : TIANJIN
- B : BAZHOU
- D : DONGGUAN
- Y : YANTAI

* PIN REMOVE: #3, 4

* PIN LENGTH : BEFORE SOLDERING

NO	REVISION	DATE	CHECK	DRAWN	CHECKED	APPROVED
1						
2						
3						
4						

CUSTOMER : GREEN C&C CO., LTD.

<h1>SPECIFICATION</h1>		SHEET NO.	
		D A T E	2005. 07. 05.
ITEM	INVERTER TRANS	MODEL NAME	
PART NO.	0 GT-209	DESCRIPTION	EFD18x20 (EEA17.7mm)

7. SCHEMATIC DIAGRAM

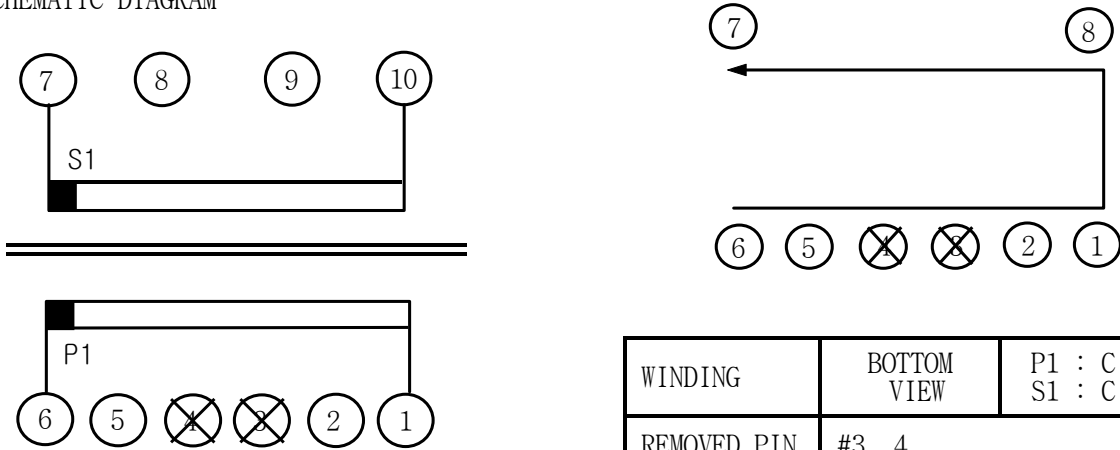

8. WINDING SPECIFICATION

NO	TERMINAL		WIRE	TURNS	WINDING METHOD	INSULATION			
	S	F				MATERIAL	T/W	TS	
S1	7	10	Grd2 0.03Ø	TOTAL 2700t	450.0	RANDOM	-	-	-
					450.0	RANDOM	-	-	-
					450.0	RANDOM	-	-	-
					450.0	RANDOM	-	-	-
					450.0	RANDOM	-	-	-
					450.0	RANDOM	-	-	-
					BLANK	-	-	-	-
P1	6	1	1UEW0.35Ø	22t	SOLENOID	-	-		
CORE FIXING TAPE						POLYESTER TAPE	0.025t, W=5.0mm	3	
OUTER WRAP TAPE						POLYESTER TAPE	0.025t, W=13.5	1.5MIN	

NO	REVISION	DATE	CHECK	DRAWN	CHECKED	APPROVED
1						
2						
3						
4						

CUSTOMER : GREEN C&C CO., LTD.

<h1>SPECIFICATION</h1>		SHEET NO.	
		D A T E	2005. 07. 05.
ITEM	INVERTER TRANS	MODEL NAME	
PART NO.	O GT-209	DESCRIPTION	EFD18x20 (EEA17.7mm)

9. ELECTRICAL CHARACTERISTIC

NO.	ITEM	TERMINAL	SPECIFICATION	REMARKS
1	INDUCTANCE (Ls MODE)	6 - 1	450.0uH MIN ※ PRIMARY INDUCTANCE SORTING L : 450 uH ~ 550 uH N : 550 uH ~ 700 uH H : 700 uH ~ 800 uH	HP-4284A at 1KHz, 1Vrms 25°C
		7 - 10	6.5H MIN	
2	LEAKAGE (Ls MODE)	6 - 1 (7-10 SHORT)	24.0uH ± 7%	
		7 - 10 (6-1 SHORT)	368mH ± 7%	
3	DC RESISTANCE	6 - 1	0.12Ω ± 10%	WHEATSTONE BRIDGE YEW TYPE 2755 HIOKI TYPE 3220
		7 - 10	1.9KΩ ± 10%	
4	IMPULSE TEST	7 - 10	AC 1.4KV R.M.S 3 SEC FREQUENCY 60Hz	
5	WITHSTAND VOLTAGE	P COIL - S COIL	AC 3.0KV R.M.S 1SEC	KIKUSUI TOS-9200 (CURRENT SENSITIVE 5mA)
		P COIL - CORE	AC 2.2KV R.M.S 1SEC	
		S COIL - CORE	AC 2.2KV R.M.S 1SEC	
6	INSULATION RESISTANCE	P.S COIL - CORE	100MΩ MIN. at DC 500V	KIKUSUI TOS-9200

NO	REVISION	DATE	CHECK	DRAWN	CHECKED	APPROVED
1						
2						
3						
4						

CUSTOMER : GREEN C&C CO., LTD.

<h1>SPECIFICATION</h1>		SHEET NO.	
		D A T E	2005. 07. 05.
ITEM	INVERTER TRANS	MODEL NAME	
PART NO.	O GT-209	DESCRIPTION	EFD18x20 (EEA17.7mm)

10. FREQUENCY CHARACTERISTIC

NO	1KHz	10KHz	20KHz	30KHz	40KHz	50KHz	75KHz	100KHz
	uH	uH	uH	uH	uH	uH	uH	uH
1	674.00	747.23	1220.00	7230	-899.26	-363.73	-103.71	-41.40
2	693.00	776.34	1230.00	-5670	-770.21	-329.77	-96.14	-38.01
3	703.00	780.07	1210.00	4310	-844.70	-353.04	-102.30	-40.97
AVG.	690.00	767.88	1220.00	1957	-838.06	-348.85	-100.72	-40.13

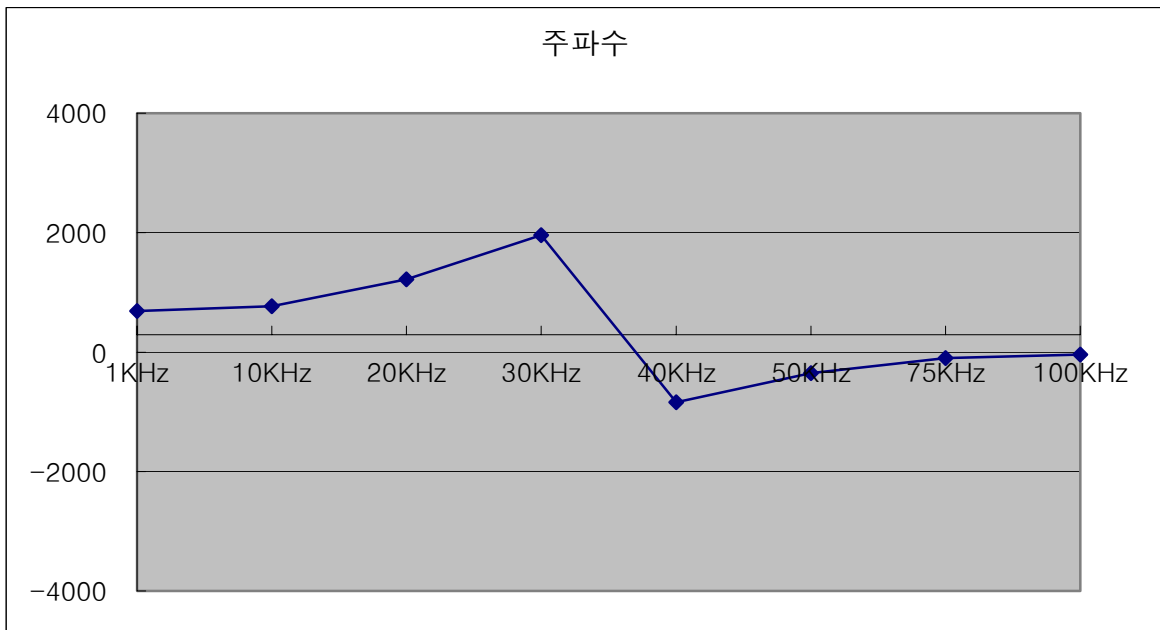

NO	REVISION	DATE	CHECK	DRAWN	CHECKED	APPROVED
1						
2						
3						
4						

CUSTOMER : GREEN C&C CO., LTD.

<h1>SPECIFICATION</h1>		SHEET NO.	
		D A T E	2005. 07. 05.
ITEM	INVERTER TRANS	MODEL NAME	
PART NO.	O GT-209	DESCRIPTION	EFD18x20 (EEA17.7mm)

11. LEAKAGE CHARACTERISTIC

NO	1KHz	10KHz	20KHz	30KHz	40KHz	50KHz	75KHz	100KHz
	uH	uH	uH	uH	uH	uH	uH	uH
1	24.59	24.17	24.17	24.18	24.20	23.35	24.27	24.28
2	24.77	24.05	24.05	24.06	24.07	22.60	24.13	24.20
3	24.87	24.16	24.16	24.16	24.17	24.15	24.23	24.30
AVG	24.74	24.13	24.13	24.13	24.15	23.37	24.21	24.26

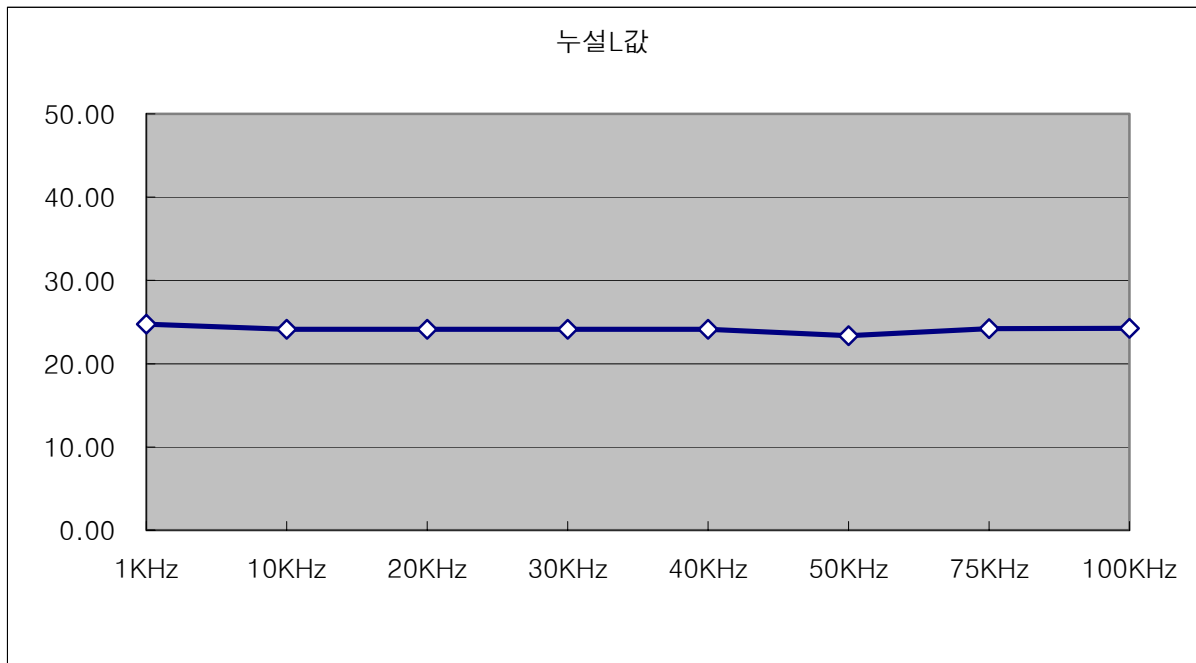

NO	REVISION	DATE	CHECK	DRAWN	CHECKED	APPROVED
1						
2						
3						
4						

CUSTOMER : GREEN C&C CO., LTD.

<h1>SPECIFICATION</h1>		SHEET NO.	
		D A T E	2005. 07. 05.
ITEM	INVERTER TRANS	MODEL NAME	
PART NO.	O GT-209	DESCRIPTION	EFD18x20 (EEA17.7mm)

12. SATURATION CHARACTERISTIC

NO	0mA	30mA	50mA	70mA	90mA	110mA	120mA	130mA	150mA	160mA
	uH	uH	uH	uH	uH	uH	uH	uH	uH	uH
1	674.00	710.34	680.42	664.15	598.40	544.28	514.65	487.43	432.39	405.34
2	693.00	716.21	678.73	634.12	584.29	531.82	503.80	478.40	427.30	402.38
3	703.00	698.14	668.68	631.10	586.00	535.98	508.66	483.60	433.63	408.60
AVG	690.00	708.23	675.94	643.12	589.56	537.36	509.04	483.14	431.11	405.44

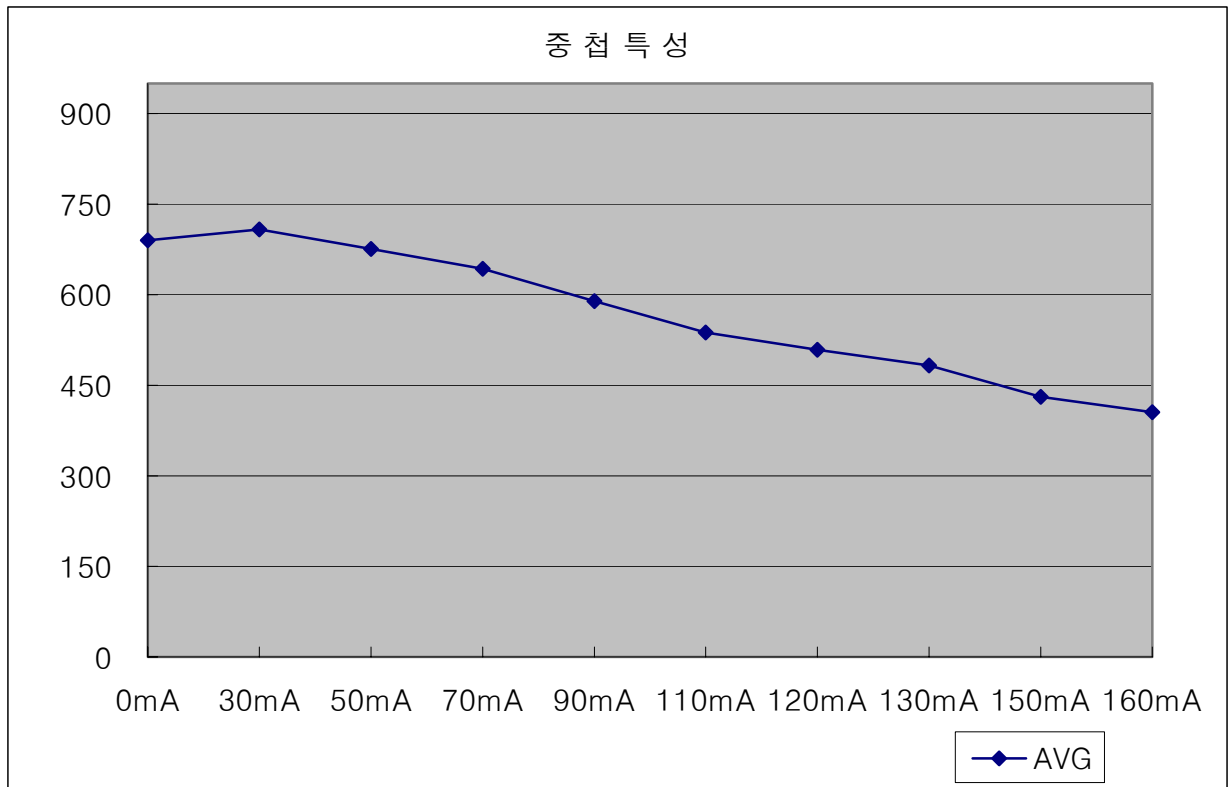

NO	REVISION	DATE	CHECK	DRAWN	CHECKED	APPROVED
1						
2						
3						
4						

CUSTOMER : GREEN C&C CO., LTD.

<h1>SPECIFICATION</h1>		SHEET NO.	
		D A T E	2005. 07. 05.
ITEM	INVERTER TRANS	MODEL NAME	
PART NO.	O GT-209	DESCRIPTION	EFD18x20 (EEA17.7mm)

13. INTERNAL CONSTRUCTION

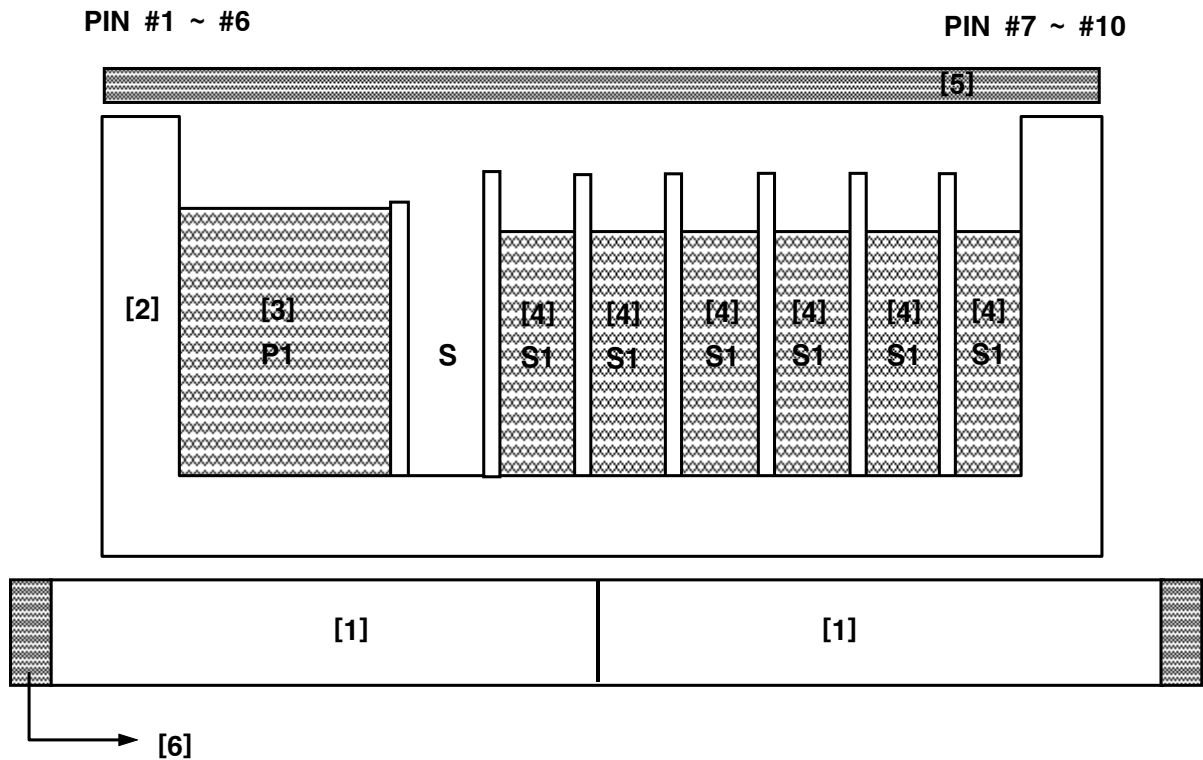

[1]:CORE [2]:BOBBIN [3],[4]:WIRE [5]:INSULATION TAPE
[6]:CORE FIXING TAPE



NO	REVISION	DATE	CHECK	DRAWN	CHECKED	APPROVED
1						
2						
3						
4						

CUSTOMER : GREEN C&C CO., LTD.

<h1>SPECIFICATION</h1>		SHEET NO.	
		D A T E	2005. 07. 05.
ITEM	INVERTER TRANS	MODEL NAME	
PART NO.	O GT-209	DESCRIPTION	EFD18x20 (EEA17.7mm)

14. MATERIAL LIST

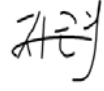
NO	MATERIAL	ITEM	MANUFACTURER	UL FILE NO
1	CORE	EFD 18 x 20 (GAP : NO GAP) PL-7,PM-7,YP-2	SAM HWA ELECTRONICS CO., LTD. ISU CERAMICS CO.,LTD. YOUNG HWA FERRITE CO., LTD.	
2	BOBBIN	EFD 18 x 20(EEA17.7) L.C.P(E4008K) (94V-0)	SUMITOMO CHEMICAL CO., LTD.	E54705M
3	PRI WIRE	1UEW 0.35	DONGYANG ELECTRONICS CO., LTD. YOUNG WHA SA CO.,LTD.	E102761S E141925S
4	SEC WIRE	GRD2 0.03Ø	ELEKTRISOLA SDN BHD.	E143312M
5	INSULATION TAPE	POLYESTER TAPE 0.025tx13.5mm	DUCK SUNG HITECH CO., LTD. (CAT No:DTS-204) HYUN DAI CHEMICAL CO., LTD. (CAT No:800(a))	E105147
		POLYESTER TAPE 0.025t x 4.0mm		E162848S
6	INSULATOR	P.E.T FILM	SKC LTD	E74359S
7	ADHESIVE	SE9189L (94V-0)	TODAY DOW CORNING SILICONE CO., LTD	E55519
8	IMPREGNATION	EPOXY SR-337, KH-337	SE GYE CHEMICAL CO., LTD.	
9	SOLDER BAR	SN98CU2-B20	SAMWOO ALLOYMETAL CO., LTD.	

NO	REVISION	DATE	CHECK	DRAWN	CHECKED	APPROVED
1						
2						
3						
4						

CUSTOMER : GREEN C&C CO., LTD.

<h1>SPECIFICATION</h1>		SHEET NO.	
		D A T E	2005. 07. 05.
ITEM	INVERTER TRANS	MODEL NAME	
PART NO.	O GT-209	DESCRIPTION	EFD18x20 (EEA17.7mm)

* BOBBIN

SUMITOMO CHEMICAL CO.,LTD. **E54705 (M)**
5-33 KITAHAMA 4-CHOMA CHUO-KU, OSAKA JAPAN
WILMINGTON DE 19898

Mtl Dsg	Col	Min Thk mm	UL94 Flame Class	Elec Imp	Mech with Imp	w/o Imp	H W	H A	V T	4 9	C T
Liquid Crystal Polyester (LCP), designated "EKONOL" or "SUMIKASUPER", furnished in the form of pellets.											

E-4008(k)	NC,WT,BK	0.30	94V-0	130	130	130	-	-	-	-	-
		0.75	94V-0	220	180	220	3	4	-	-	-
		1.5	94V-0	220	200	240	2	4	-	-	-
		3.0	94V-1	220	200	240	1	4	0	5	4

Reports : November 10, 1994 August 17, 1992 August 17, 1992



Replaces E547050010 dated August 16, 1994. (Cont. or CO11 card)
 683604011 n7047 Underwriters Laboratories Inc. Dh/0246672

* WIRE (PRI)

DONG YANG ELECTRONICS IND CO LTD **E102761 (S)**
660-1 BANWOL-RI TAIAN-EWB HWASUNG-GUN,
KYUNGGI-DO KOREA

Mtl Dsg	BC	Cost typ	OC	ANSI Type	TI
AI-EIW	Polyesterimide		Polyamideimide	MW35	200
EIW	Polyesterimide			MW30	180
NY-EIW	Polyester- amide-imide		Polyamide	MW96	180
NY-PEW	Polyester		Polyamide	MW24	155
NY-PEW(F)	Polyester		Polyamide	MW24	155
NY-UEW	Polyurethane		Polyamide	MW23	130
UEW	Polyurethane		-	MW75	130

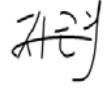
Marking: Company name or "E102761" and material designation or marked designation on package or reel, and recognized Component Mark.

NO	REVISION	DATE	CHECK	DRAWN	CHECKED	APPROVED
1						
2						
3						
4						

CUSTOMER : GREEN C&C CO., LTD.

<h1>SPECIFICATION</h1>		SHEET NO.	
		D A T E	2005. 07. 05.
ITEM	INVERTER TRANS	MODEL NAME	
PART NO.	0 GT-209	DESCRIPTION	EFD18x20 (EEA17.7mm)

* WIRE (PRI)

OBMW2 May 2, 1997
Component -Magnet Wire

YOUNG WHA SA CO LTD E141925 (S)
256-1 DODANG-DONG WONMI-KU BUCHON, KYONGGI-DO
421-130 KOREA

Mtl	Cost typ	Overcoat	ANSI Typ (+)	TI
Dsg AEW-R	BC Modified Polyester	Polyamideimide	MW73-C	200
AI-EIW	Modified Polyester	Polyamideimide	MW35-C	200
UEW-F	Polyurethane	-	MW79-C	155
NPW	Polyester-nylon	Nylon	MW24-C	155
NUW	Polyurethane-nylon	Nylon	MW28-C	130
YHW-B	Polyurethane	-	MW75-C	130
UEW-B	Polyurethane	-	MW75-C	130

Reports: June 19, 1992; June 19, 1992; June 19, 1992, January 4, 1994; November 7, 1995; June 24, 1996; January 30, 1997.

Replaces E141925A dated March 4, 1997. (Cont. on B card)
746041001 H0110 Underwriters Laboratories Inc. D11/0213429 24

* WIRE (SEC)

OBMW2 January 15, 1997
Component -Magnet Wire

ELEKTRISOLA (MALAYSIA) SDN BHD E143312 (M)
(B-cont.from A card)

Polysol 155	P155	Polyurethane	-	MW-79	155
				MW-75	130
Polysol 155g	Pg155	Polyurethane	-	MW75	130
Polysol 155p	Pp155,Gp155	Polyurethane	-	MW79	155
Polysol 160	p160	Polyurethane	-	MW-79	155
Polysol 160	P180,G180	Polyurethane	-	MW79	155

Marking: Company name, material designation or marked designation on package or reel and Recognized Component Mark.

See General Information Preceding These Recognitions.

For use only in equipment where the acceptability of the combination is determined by Underwriters Laboratories Inc.

Reports: March 13, 1992; March 13, 1992; March 13; 1992, March 13, 1992; March 13, 1992.

Replaces E143312 E143312B dated April 20, 1992.
768673002 N3347 Underwriters Laboratories Inc. D11/0210461



NO	REVISION	DATE	CHECK	DRAWN	CHECKED	APPROVED
1						
2						
3						
4						

CUSTOMER : GREEN C&C CO., LTD.

<h1>SPECIFICATION</h1>		SHEET NO.	
		D A T E	2005. 07. 05.
ITEM	INVERTER TRANS	MODEL NAME	
PART NO.	O GT-209	DESCRIPTION	EFD18x20 (EEA17.7mm)

* INSULATION TAPE

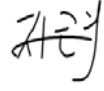
<p>QANZ2 Insulating Tape-Component DUCK SUNG HITECH CO LTD DAESUNG BLDG 677 JAYANG-DONG KWANG JIN-KU SEOUL 133-190, KOREA</p>	E105147
<p>Polyester film insulating tape, acrylic adhesive, Cat. No. DTS-204, rated 130 C. Acetate cloth insulating tape, acrylic adhesive, Cat. No. 231*, rated 105 C. Glass cloth insulating tape, rubber adhesive, Cat. No. 220-B, rated 130 C. Glass cloth insulating tape, silicone adhesive, Cat. No. 221H*, rated 180 C. Acetate cloth insulating tape, rubber adhesive, Cat. No. DTS-230, rated 105 C. Nomex (Aramid fiber) film insulating tape with non-woven polyester fiber reinforcement, acrylic adhesive, Cat. No. DTS-241*, rated 130 C. Polyester film insulating tape, acrylic adhesive, Cat. No. DTS-280*, rated 130 C. PET (polyester) film insulating tape, synthetic rubber adhesive, Cat. No. DTS -204R %, rated 130 C. PET(polyester) film insulated tape, acrylic adhesive, Cat. No. DTS-204F*#, rated 130C. Flame retardant cotton cloth tape, rubber adhesive, Cat. No. DTS-250F*+. Flame retardant acetate cloth tape, rubber adhesive, Cat. No. DTS-232F+. Flame retardant Aluminum foil tape, acrylic adhesive, Cat. No. DTS-800A+. Flame retardant Aluminum foil with PET film tape, acrylic adhesive, Cat. No. DTS-810+. Flame retardant Copper foil tape, acrylic adhesive, Cat. No. DTS-820+. Flame retardant Nickel coated Polyester Fiber tape, acrylic adhesive, Cat. No. DTS-830+. Glass cloth insulating tape, acrylic adhesive, Cat. No. DTS-221F*, rated 155 C. PET (polyester) film insulating tape with non-woven polyester fiber reinforcement, rubber adhesive, Cat. No. DTS-280R@, rated 130C. PET (Polyester) film insulating tape, acrylic adhesive , Cat. No. DTS-204B&, rated 130 C. PET (Polyester) film insulating tape, acrylic adhesive , Cat. No. DTS-204K^, rated 130 C. * - Complies with flame retardant requirements when so marked. + - Must be marked "Flame Retardant". # - May be marked: "Film side CTI Performance Level Category PLC=3 Voltage 235, per UL 746A/ASTM D 3638", and/or "Adhesive side CTI Performance Level Category PLC=0 Voltage 600, per UL 746A/ASTM D 3638" or equivalent. % - May be marked: "Film side CTI Performance Level Category PLC=2 Voltage 325, per UL 746A/ASTM D 3638", and/or "Adhesive side CTI Performance Level Category PLC=1 Voltage 575, per UL 746A/ASTM D 3638" or equivalent. @ - May be marked: "Film side CTI Performance Level Category PLC=0 Voltage 600+, per UL 746A/ASTM D 3638," and/or "Adhesive side CTI Performance Level Category PLC=0 Voltage 600+, per UL 746A/ASTM D 3638" or equivalent. & - May be marked: "Film side CTI Performance Level Category PLC=2 Voltage 260, per UL 746A/ASTM D 3638," and/or "Adhesive side CTI Performance Level Category PLC=0 Voltage 600, per UL 746A/ASTM D 3638" or equivalent. ^ - May be marked: "Film side CTI Performance Level Category PLC=2 Voltage 250, per UL 746A/ASTM D 3638," and/or "Adhesive side CTI Performance Level Category PLC=0 Voltage 600, per UL 746A/ASTM D 3638" or equivalent.</p> <p>Marking: Company name or trademark or file number "E105147" and catalog designation printed on carton, wrapper or core.</p>	

NO	REVISION	DATE	CHECK	DRAWN	CHECKED	APPROVED
1						
2						
3						
4						

CUSTOMER : GREEN C&C CO., LTD.

SPECIFICATION		SHEET NO.	
		D A T E	2005. 07. 05.
ITEM	INVERTER TRANS	MODEL NAME	
PART NO.	0 GT-209	DESCRIPTION	EFD18x20 (EEA17.7mm)

* INSULATION TAPE

OANZ2 April 7, 1997 E162848 (S)
 Component - Insulating Tape

HYUN DAI CHEMICAL CO LTD
 258 YEULMI-RI SILCHON-MYON KWANGJU, KYONGGI-DO
 464-870 KOREA

Polyester tape with acrylic adhesive, Cat. No. 800(a) for use at temperatures not exceeding 130°C
 (a) Comparative Tracking Index (CTI) assigned PLC = 0, voltage = 600V or greater, CTI600.
 Marking: Company name, catalog designation and temperature rating printed on carton, wrapper or core.

See General Information Preceding These Recognitions.
 For use only in equipment where the acceptability of the combination is determined by Underwriters Laboratories Inc

Reports: October 20, 1994.

Replaces E162848 dated October 21, 1994.
 105798001 Underwriters Laboratories Inc. D11/0264017 22

* INSULATOR

QMFZ2 E74359
 COMPONENT - PLASTICS

SKC CO LTD
 PLANT MANAGEMENT TEAM
 633 CHONGJA-DONG
 SUWON-SHI, CHANGAN-GU
 KYONGGI-DO 440-840, KOREA

Material Dsg	Color	mm	Class	I	I	Elec	R T I		H	D	C
							Imp	Str			
SR01, SR50, SR53, SS51	NC	0.05	VTM-2	-	-	105	105	105	V	4	T
									T	9	I

- Represents a numeric suffix from "00" to "99" except 55 for grade SR##.
 @ - Represents alphabetical suffix from "A" to "Z" (Second @ may be omitted).
 Marking: Company name or tradename "SKC" and material designation on container, wrapper or finished part.

Last Updated on 2004-10-22



NO	REVISION	DATE	CHECK	DRAWN	CHECKED	APPROVED
1						
2						
3						
4						

CUSTOMER : GREEN C&C CO., LTD.

<h1>SPECIFICATION</h1>		SHEET NO.	
		D A T E	2005. 07. 05.
ITEM	INVERTER TRANS	MODEL NAME	
PART NO.	O GT-209	DESCRIPTION	EFD18x20 (EEA17.7mm)

* ADHESIVE

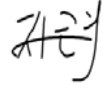
DOW CORNING TORAY SILICONE CO LTD											E55519			
AIG BLDG														
1-1-3 MARUNOUCHI														
CHIYODA-KU														
TOKYO 100-0005, JAPAN														
				Min.		H	H		RTI		H	D		
				Thk	Flame	W	A	Elec		Mech	V	4	C	
Material	Dsg		Color	mm	Class	I	I		Imp	Str	R	5	I	
SE9189L	GRAY	RTV	GV	0.75	V-0	3	-	150	150	150	-	-	-	
1.5 V-0 0 - 150 150 150 - - -														
SE9189L WHITE RTV NC, WT 0.75 V-0 - - 150 150 150 - - -														

NO	REVISION	DATE	CHECK	DRAWN	CHECKED	APPROVED
1						
2						
3						
4						

CUSTOMER : GREEN C&C CO., LTD.

<h1>SPECIFICATION</h1>		SHEET NO.	
		D A T E	2005. 07. 05.
ITEM	INVERTER TRANS	MODEL NAME	
PART NO.	O GT-209	DESCRIPTION	EFD18x20 (EEA17.7mm)

* CORE SIZE (Unit:mm)

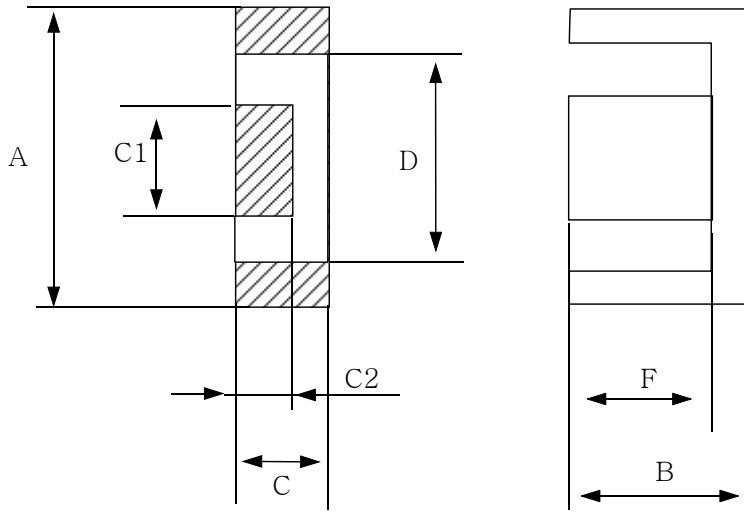

A	B	C	C1	C2	D	F
17.7±0.30	10.2±0.10	5.6±0.15	7.5±0.15	3.4±0.15	13.1min	7.8±0.20

*. NO GAP → AL-value (nH/N2) : 1300



NO	REVISION	DATE	CHECK	DRAWN	CHECKED	APPROVED
1						
2						
3						
4						

CUSTOMER : GREEN C&C CO., LTD.

<h1>SPECIFICATION</h1>		SHEET NO.	
		D A T E	2005. 07. 05.
ITEM	INVERTER TRANS	MODEL NAME	
PART NO.	O GT-209	DESCRIPTION	EFD18x20 (EEA17.7mm)

* CORE

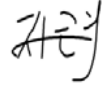
SYMBOL	UNIT	TEMP	PL-7	PM-7	YP-2
μiac	-	25℃	2400±25%	2400±25%	2500±25%
Bs H=1200A/m	mT	25℃	490	490	510
		100℃	380	380	400
Hc	A/m	25℃	12	13	5.5
		100℃	-	10	-
Br H=1200A/m	mT	25℃	150	140	60
		100℃	-	-	40
Tc	℃	-	>220	>210	>220
Pv F=100KHz B=200mT	mW/cm ³	25℃	640	700	600
		100℃	450	410	440
p	Ω . m		5.0	7	6
d	kg/m ³		4.85x10 ³	4.8x10 ³	4.8x10 ³

NO	REVISION	DATE	CHECK	DRAWN	CHECKED	APPROVED
1						
2						
3						
4						

CUSTOMER : GREEN C&C CO., LTD.

<h1>SPECIFICATION</h1>		SHEET NO.	
		D A T E	2005. 07. 05.
ITEM	INVERTER TRANS	MODEL NAME	
PART NO.	O GT-209	DESCRIPTION	EFD18x20 (EEA17.7mm)

* BOBBIN SIZE (Unit:mm)

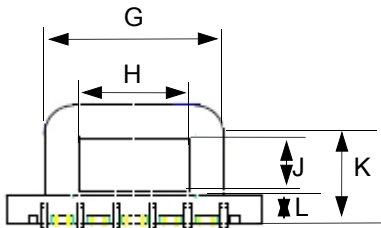
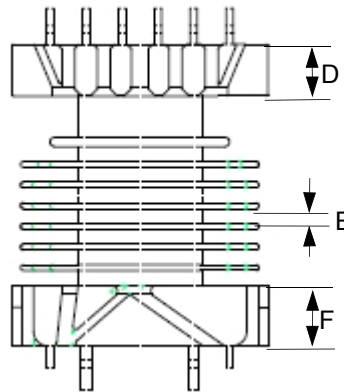
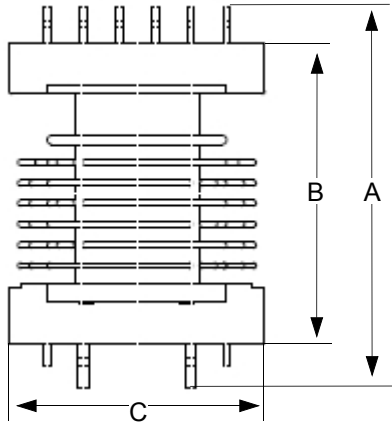

** Sn : 4um MIN

** Ni : 1um MIN



	A	B	C	D	E	F	G	H	J	K	L
SPEC	26.5 ±0.20	21.0 ±0.20	17.8 ±0.20	3.6 ±0.20	1.04 ±0.20	4.2 ±0.20	12.5 ±0.20	7.7 ±0.20	3.6 ±0.20	8.2 ±0.20	2.3 ±0.20
1	26.56	21.02	17.85	3.66	1.04	4.21	12.46	7.69	3.60	8.17	2.34
2	26.59	21.02	17.87	3.69	1.04	4.21	12.48	7.68	3.60	8.16	2.33
3	26.58	21.01	17.88	3.65	1.04	4.20	12.47	7.68	3.60	8.15	2.34
4	26.58	21.00	17.86	3.68	1.04	4.21	12.48	7.69	3.61	8.15	2.32
5	31.77	27.42	17.87	3.65	1.04	4.20	12.48	7.68	3.59	8.16	2.33

NO	REVISION	DATE	CHECK	DRAWN	CHECKED	APPROVED
1						
2						
3						
4						

CUSTOMER : GREEN C&C CO., LTD.

<h1>SPECIFICATION</h1>		SHEET NO.	
		D A T E	2005. 07. 05.
ITEM	INVERTER TRANS	MODEL NAME	
PART NO.	O GT-209	DESCRIPTION	EFD18x20 (EEA17.7mm)

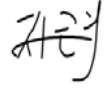
ITEM	BOBBIN	WIRE	POLYESTER TAPE
STANDARD	94V-0	130°C	130°C
1	OK	OK	OK
2	OK	OK	OK
3	OK	OK	OK
4	OK	OK	OK
5	OK	OK	OK
6	OK	OK	OK
7	OK	OK	OK
8	OK	OK	OK
9	OK	OK	OK
10	OK	OK	OK

NO	REVISION	DATE	CHECK	DRAWN	CHECKED	APPROVED
1						
2						
3						
4						

CUSTOMER : GREEN C&C CO., LTD.

<h1>SPECIFICATION</h1>		SHEET NO.	
		D A T E	2005. 07. 05.
ITEM	INVERTER TRANS	MODEL NAME	
PART NO.	O GT-209	DESCRIPTION	EFD18x20 (EEA17.7mm)

* BONDING

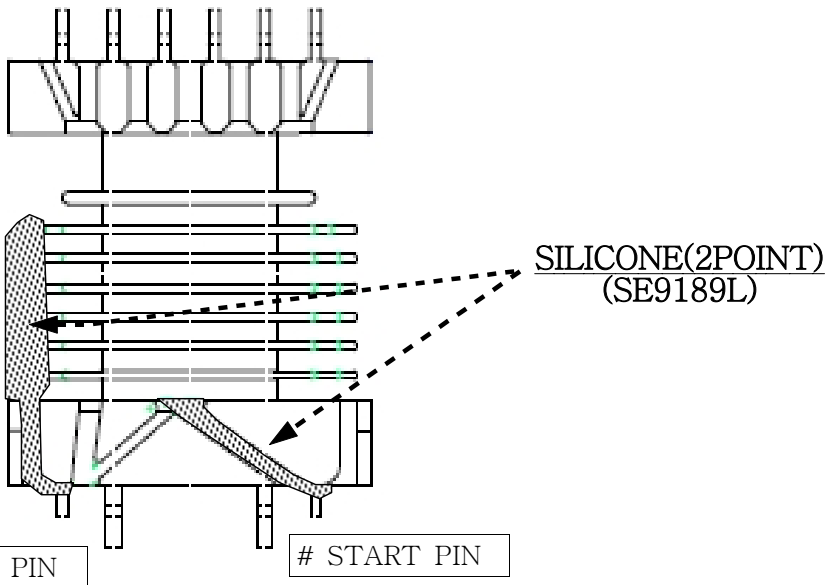

NO	REVISION	DATE	CHECK	DRAWN	CHECKED	APPROVED
1						
2						
3						
4						

INSPECTION REPORT

CODE NO	0 GT-209	DATE OF MEASUREMENT	2005. 06. 16.
PART NAME	INVERTER TRANS	TEMPERATURE	20 °C 30 %
TYPE OF SET	0 GT-209	TESTING INSTRUMENT	LCR-METER HP-4284A DCR-METER HIOKI TYPE 3220
DONGHEUNG TYPE	EFD1322		
SAMPLE QUANTITY	5 EA	APPROVED BY	<i>S.C. Lee</i>
CUSTOMER	GREEN C&C	CHECKED BY	<i>지은경</i>
MANUFACTURER	DONGHEUNG	INSPECTED BY	<i>[Signature]</i>

ITEM	INDUCTANCE		DCR		LEAKAGE		LEAKAGE	
	(7-10)	(6-1)	(7-10)	(6-1)	(7-10)	(6-1)	(7-10)	(6-1)
STANDARD	1kHz, 1V H(Ls)	1kHz, 1V uH(Lp)	KΩ	Ω	1kHz, 1V mH(Ls)	1kHz, 1V uH(Ls)	50kHz, 1V mH(Ls)	50kHz, 1V uH(Ls)
1	9.14	674.00	1.918	0.120	368.44	24.59	506.74	23.35
2	9.43	693.00	1.910	0.120	368.44	24.77	495.69	22.60
3	9.62	703.00	1.908	0.120	369.66	24.87	460.66	24.15
4	9.55	708.00	1.896	0.120	367.77	24.69	451.69	24.02
5	8.87	663.00	1.893	0.121	367.16	24.72	445.89	23.79
6								
7								
8								
9								
10								
AVG	9.32	688.20	1.905	0.120	368.29	24.73	472.13	23.58
MAX	9.62	708.00	1.918	0.121	369.66	24.87	506.74	24.15
MIN	8.87	663.00	1.893	0.120	367.16	24.59	445.89	22.60
R	0.75	45.00	0.025	0.001	2.50	0.28	60.85	1.55

REMARKS