

GI20N03

N-CHANNEL ENHANCEMENT MODE POWER MOSFET

| | |
|---------|------|
| BVDSS | 30V |
| RDS(ON) | 52mΩ |
| ID | 20A |

Description

The GI20N03 provide the designer with the best combination of fast switching, ruggedized device design, low on-resistance and cost-effectiveness.

The through-hole version (TO-251) is available for low-profile applications and suited for low voltage applications such as DC/DC converters.

Features

- *Dynamic dv/dt Rating
- *Repetitive Avalanche Rated
- *Simple Drive Requirement
- *Fast Switching

Package Dimensions

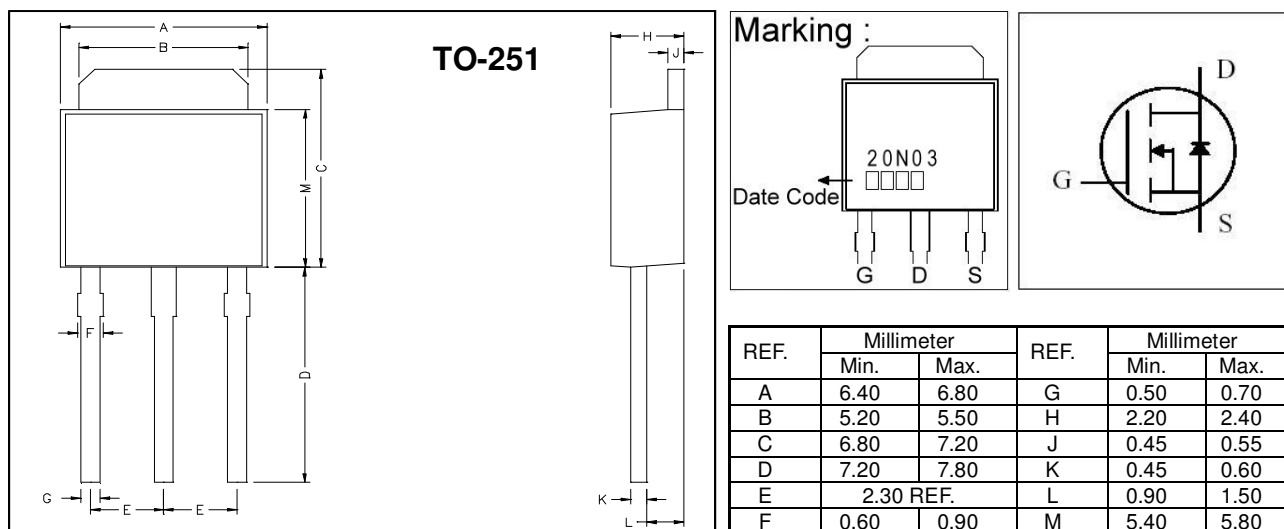

Absolute Maximum Ratings

| Parameter | Symbol | Ratings | Unit |
|--------------------------------------------------|------------------------|------------|---------------|
| Drain-Source Voltage | V_{DS} | 30 | V |
| Gate-Source Voltage | V_{GS} | ± 20 | V |
| Continuous Drain Current, $V_{GS}@10V$ | $I_D @T_C=25^\circ C$ | 20 | A |
| Continuous Drain Current, $V_{GS}@10V$ | $I_D @T_C=100^\circ C$ | 13 | A |
| Pulsed Drain Current ¹ | I_{DM} | 53 | A |
| Total Power Dissipation | $P_D @T_C=25^\circ C$ | 31 | W |
| Linear Derating Factor | | 0.25 | W/ $^\circ C$ |
| Operating Junction and Storage Temperature Range | T_j, T_{stg} | -55 ~ +150 | $^\circ C$ |

Thermal Data

| Parameter | Symbol | Value | Unit |
|------------------------------------------|--------|-------|--------------|
| Thermal Resistance Junction-case Max. | Rthj-c | 4.0 | $^\circ C/W$ |
| Thermal Resistance Junction-ambient Max. | Rthj-a | 110 | $^\circ C/W$ |

Electrical Characteristics (T_j = 25°C unless otherwise specified)

| Parameter | Symbol | Min. | Typ. | Max. | Unit | Test Conditions |
|-----------------------------------------------------|--------------------------------|------|-------|------|------|----------------------------------------------------------------------------------------------------------------------|
| Drain-Source Breakdown Voltage | BV _{DSS} | 30 | - | - | V | V _{GS} =0, I _D =250uA |
| Breakdown Voltage Temperature Coefficient | $\Delta BV_{DSS} / \Delta T_j$ | - | 0.037 | - | V/°C | Reference to 25°C, I _D =1mA |
| Gate Threshold Voltage | V _{GS(th)} | 1.0 | - | 3.0 | V | V _{DS} =V _{GS} , I _D =250uA |
| Forward Transconductance | g _{fs} | - | 3 | - | S | V _{DS} =10V, I _D =10A |
| Gate-Source Leakage Current | I _{GSS} | - | - | ±100 | nA | V _{GS} = ±20V |
| Drain-Source Leakage Current(T _j =25°C) | I _{DSS} | - | - | 1 | uA | V _{DS} =30V, V _{GS} =0 |
| Drain-Source Leakage Current(T _j =150°C) | | - | - | 100 | uA | V _{DS} =24V, V _{GS} =0 |
| Static Drain-Source On-Resistance | R _{DS(ON)} | - | - | 52 | mΩ | V _{GS} =10V, I _D =10A |
| | | - | - | 85 | | V _{GS} =4.5V, I _D =8A |
| Total Gate Charge ² | Q _g | - | 6.1 | - | nC | I _D =10A V _{DS} =24V V _{GS} =5V |
| Gate-Source Charge | Q _{gs} | - | 1.4 | - | | |
| Gate-Drain ("Miller") Change | Q _{gd} | - | 4 | - | | |
| Turn-on Delay Time ² | T _{d(on)} | - | 4.9 | - | ns | V _{DS} =15V I _D =20A V _{GS} =10V R _G =3.3Ω R _D =0.75Ω |
| Rise Time | T _r | - | 29 | - | | |
| Turn-off Delay Time | T _{d(off)} | - | 14.3 | - | | |
| Fall Time | T _f | - | 3.6 | - | | |
| Input Capacitance | C _{iss} | - | 290 | - | pF | V _{GS} =0V V _{DS} =25V f=1.0MHz |
| Output Capacitance | C _{oss} | - | 160 | - | | |
| Reverse Transfer Capacitance | C _{rss} | - | 45 | - | | |

Source-Drain Diode

| Parameter | Symbol | Min. | Typ. | Max. | Unit | Test Conditions |
|-------------------------------------------------|-----------------|------|------|------|------|----------------------------------------------------------------|
| Forward On Voltage ² | V _{SD} | - | - | 1.3 | V | I _S =20A, V _{GS} =0V, T _j =25°C |
| Continuous Source Current (Body Diode) | I _S | - | - | 20 | A | V _D =V _G =0V, V _S =1.3V |
| Pulsed Source Current (Body Diode) ¹ | I _{SM} | - | - | 53 | A | |

Notes: 1. Pulse width limited by safe operating area.

2. Pulse width ≤ 300us, duty cycle ≤ 2%.

Characteristics Curve

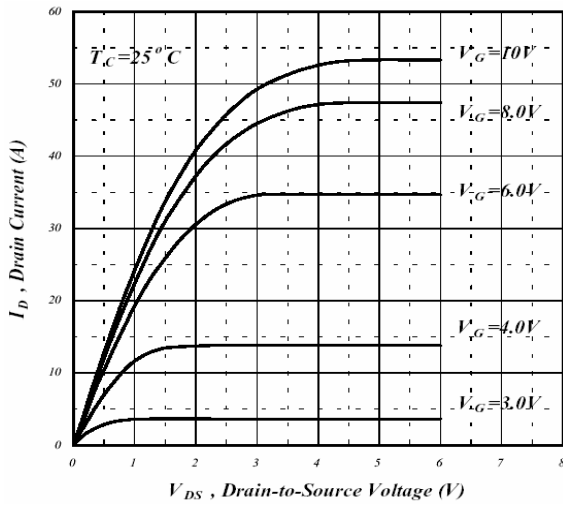

Fig 1. Typical Output Characteristics

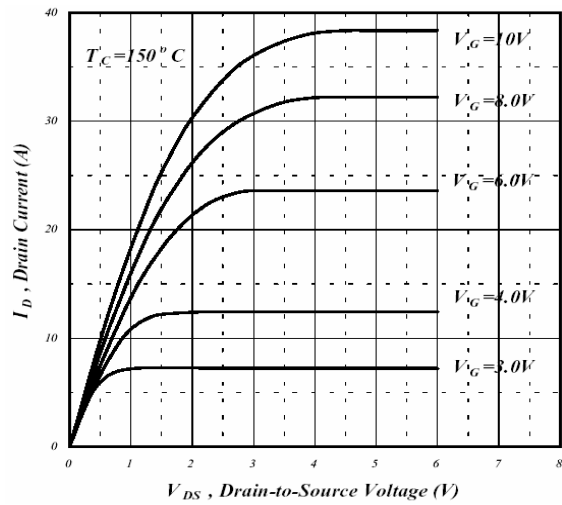

Fig 2. Typical Output Characteristics

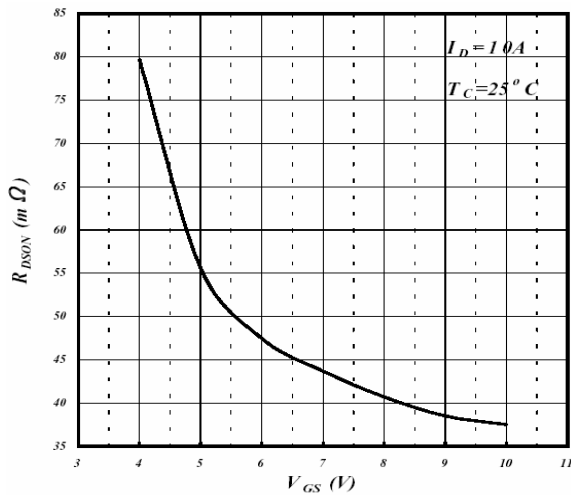

Fig 3. On-Resistance v.s. Gate Voltage

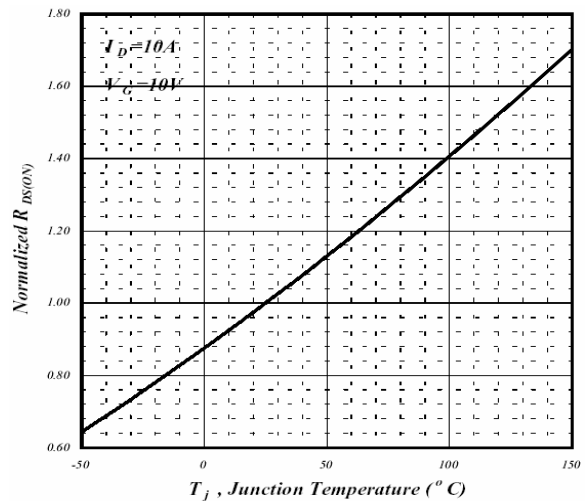

Fig 4. Normalized On-Resistance v.s. Junction Temperature

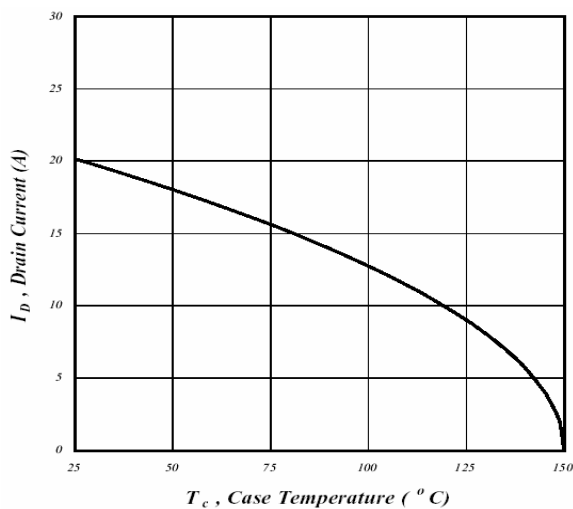

Fig 5. Maximum Drain Current v.s. Case Temperature

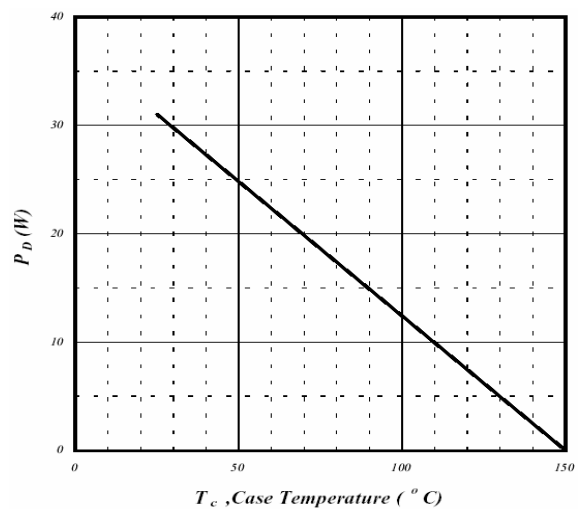

Fig 6. Type Power Dissipation

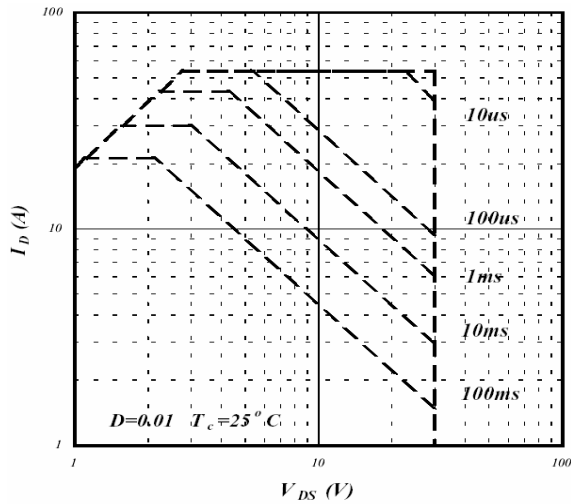

Fig 7. Maximum Safe Operating Area

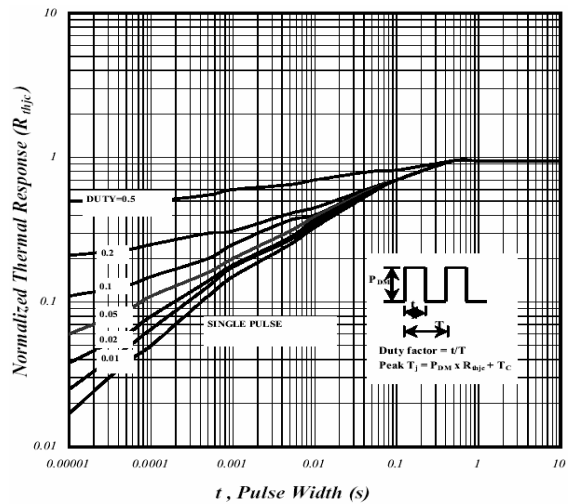

Fig 8. Effective Transient Thermal Impedance

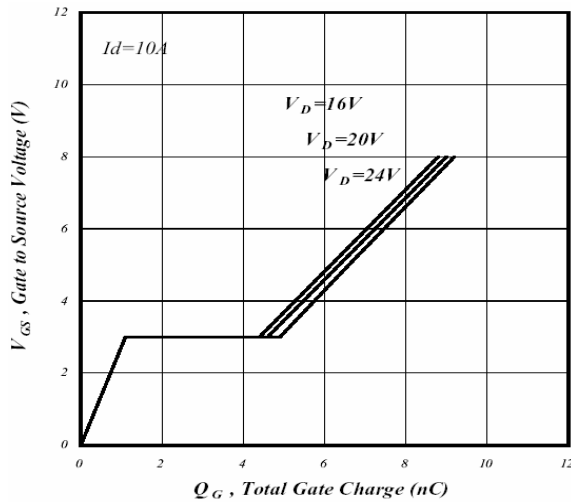

Fig 9. Gate Charge Characteristics

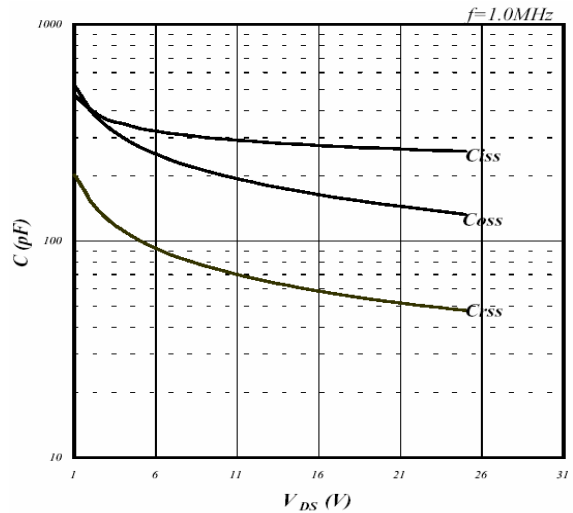

Fig 10. Typical Capacitance Characteristics

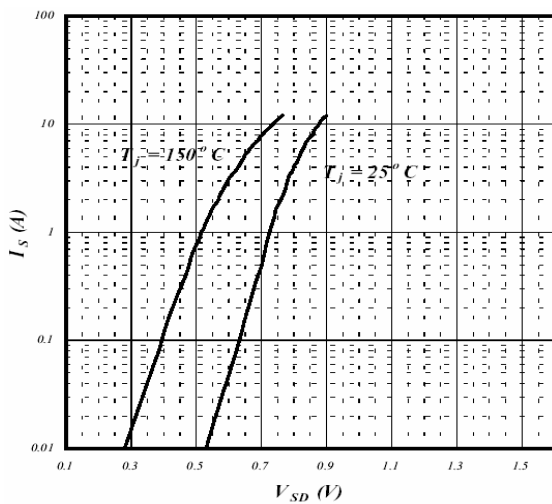

Fig 11. Forward Characteristics of Reverse Diode

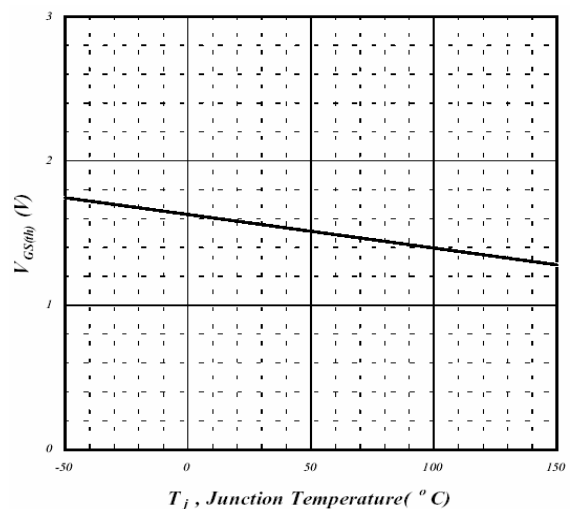

Fig 12. Gate Threshold Voltage v.s. Junction Temperature

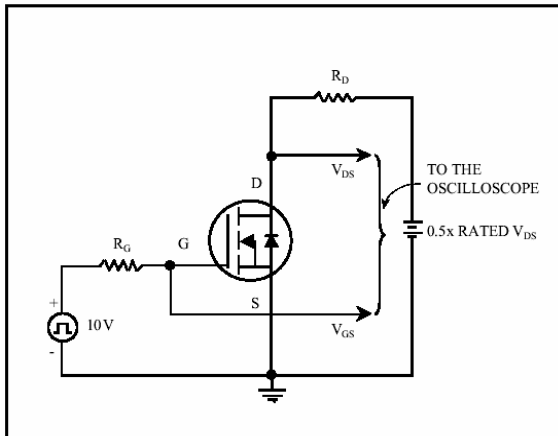

Fig 13. Switching Time Circuit

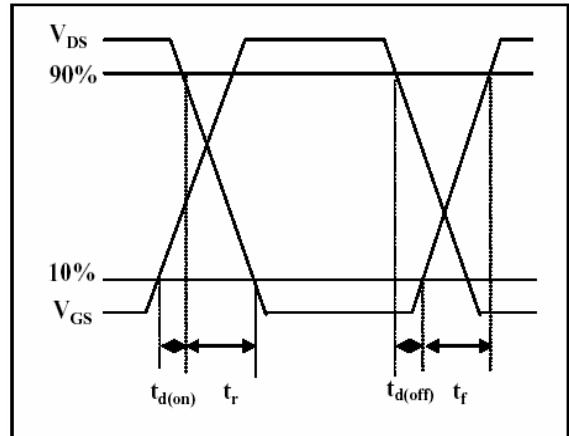

Fig 14. Switching Time Waveform

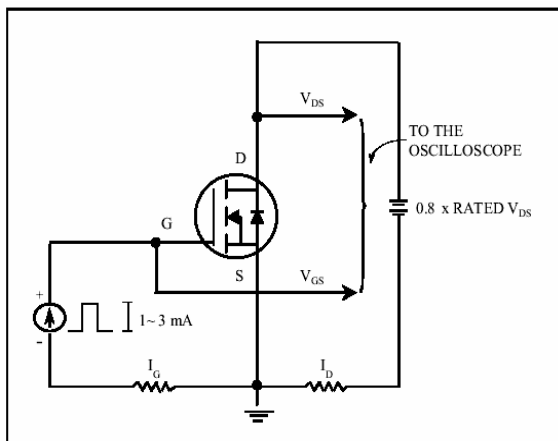

Fig 15. Gate Charge Circuit

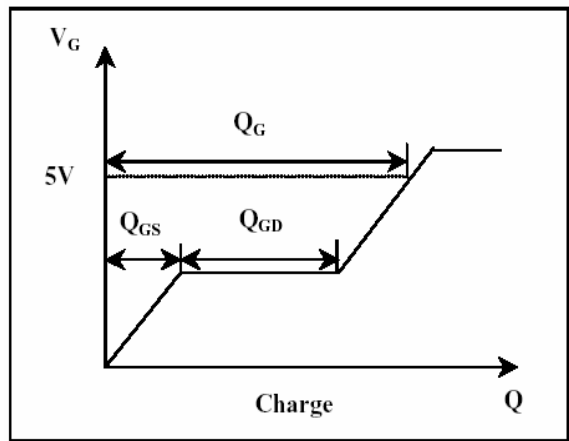

Fig 16. Gate Charge Waveform

Important Notice:

- All rights are reserved. Reproduction in whole or in part is prohibited without the prior written approval of GTM.
- GTM reserves the right to make changes to its products without notice.
- GTM semiconductor products are not warranted to be suitable for use in life-support Applications, or systems.
- GTM assumes no liability for any consequence of customer product design, infringement of patents, or application assistance.

Head Office And Factory:

- **Taiwan:** No. 17-1 Tatung Rd. Fu Kou Hsin-Chu Industrial Park, Hsin-Chu, Taiwan, R. O. C.
- TEL : 886-3-597-7061 FAX : 886-3-597-9220, 597-0785
- **China:** (201203) No.255, Jang-Jiang Tsai-Lueng RD. , Pu-Dung-Hsin District, Shang-Hai City, China
- TEL : 86-21-5895-7671 ~ 4 FAX : 86-21-38950165