

# GJ09N20

## N-CHANNEL ENHANCEMENT MODE POWER MOSFET

BVDSS	200V
RDS(ON)	380mΩ
ID	8.6A

### Description

The GJ09N20 provide the designer with the best combination of fast switching, ruggedized device design, low on-resistance and cost-effectiveness.

The TO-252 package is universally preferred for all commercial-industrial surface mount applications at power dissipation levels to approximately 50 watts.

### Features

- \*Simple Drive Requirement
- \*Lower On-resistance
- \*Fast Switching Characteristic

### Package Dimensions

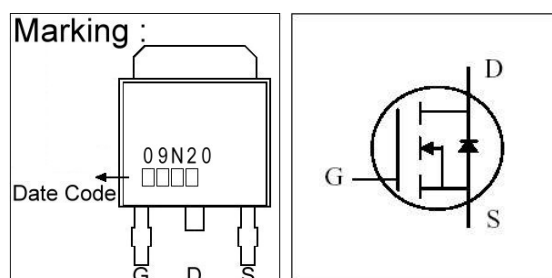
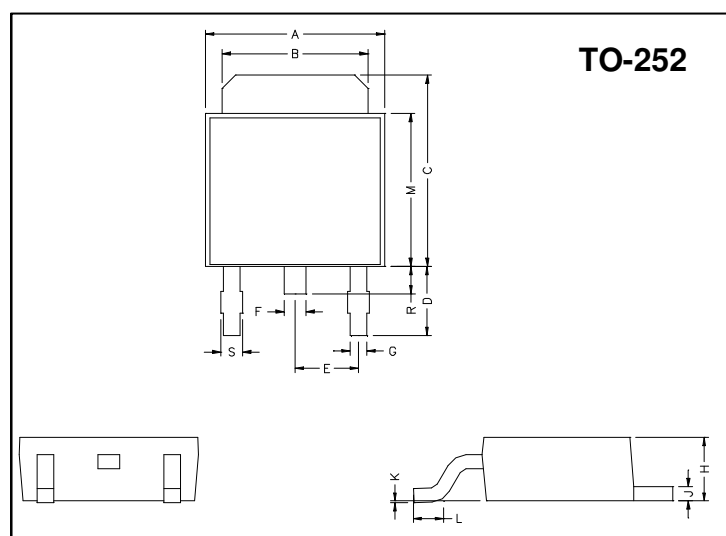

REF.	Millimeter		REF.	Millimeter	
	Min.	Max.		Min.	Max.
A	6.40	6.80	G	0.50	0.70
B	5.20	5.50	H	2.20	2.40
C	6.80	7.20	J	0.45	0.55
D	2.40	3.00	K	0	0.15
E	2.30 REF.		L	0.90	1.50
F	0.70	0.90	M	5.40	5.80
S	0.60	0.90	R	0.80	1.20

### Absolute Maximum Ratings

Parameter	Symbol	Ratings	Unit
Drain-Source Voltage	$V_{DS}$	200	V
Gate-Source Voltage	$V_{GS}$	±30	V
Continuous Drain Current, $V_{GS}@10V$	$I_D @T_C=25^{\circ}C$	8.6	A
Continuous Drain Current, $V_{GS}@10V$	$I_D @T_C=100^{\circ}C$	5.5	A
Pulsed Drain Current <sup>1</sup>	$I_{DM}$	36	A
Total Power Dissipation	$P_D @T_C=25^{\circ}C$	69	W
Linear Derating Factor		0.55	W/°C
Single Pulse Avalanche Energy <sup>2</sup>	$E_{AS}$	40	mJ
Avalanche Current	$I_{AR}$	8.6	A
Operating Junction and Storage Temperature Range	$T_j, T_{stg}$	-55 ~ +150	°C

### Thermal Data

Parameter	Symbol	Value	Unit
Thermal Resistance Junction-case Max.	$R_{thj-c}$	1.8	°C/W
Thermal Resistance Junction-ambient Max.	$R_{thj-a}$	110	°C/W

**Electrical Characteristics (T<sub>j</sub> = 25°C unless otherwise specified)**

Parameter	Symbol	Min.	Typ.	Max.	Unit	Test Conditions
Drain-Source Breakdown Voltage	BV <sub>DSS</sub>	200	-	-	V	V <sub>GS</sub> =0, I <sub>D</sub> =1mA
Breakdown Voltage Temperature Coefficient	$\Delta BV_{DSS} / \Delta T_j$	-	0.24	-	V/°C	Reference to 25°C, I <sub>D</sub> =1mA
Gate Threshold Voltage	V <sub>GS(th)</sub>	2.0	-	4.0	V	V <sub>DS</sub> =V <sub>GS</sub> , I <sub>D</sub> =250uA
Forward Transconductance	g <sub>fs</sub>	-	3.7	-	S	V <sub>DS</sub> =10V, I <sub>D</sub> =5A
Gate-Source Leakage Current	I <sub>GSS</sub>	-	-	±100	nA	V <sub>GS</sub> = ±30V
Drain-Source Leakage Current(T <sub>j</sub> =25°C)	I <sub>DSS</sub>	-	-	10	uA	V <sub>DS</sub> =200V, V <sub>GS</sub> =0
Drain-Source Leakage Current(T <sub>j</sub> =150°C)		-	-	100	uA	V <sub>DS</sub> =160V, V <sub>GS</sub> =0
Static Drain-Source On-Resistance	R <sub>DS(ON)</sub>	-	-	380	mΩ	V <sub>GS</sub> =10V, I <sub>D</sub> =5A
Total Gate Charge <sup>3</sup>	Q <sub>g</sub>	-	23	37	nC	I <sub>D</sub> =8.6A V <sub>DS</sub> =160V V <sub>GS</sub> =10V
Gate-Source Charge	Q <sub>gs</sub>	-	4	-		
Gate-Drain ("Miller") Change	Q <sub>gd</sub>	-	13	-		
Turn-on Delay Time <sup>3</sup>	T <sub>d(on)</sub>	-	12	-	ns	V <sub>DD</sub> =100V I <sub>D</sub> =8.6A V <sub>GS</sub> =10V R <sub>G</sub> =10Ω R <sub>D</sub> =11.6Ω
Rise Time	T <sub>r</sub>	-	25	-		
Turn-off Delay Time	T <sub>d(off)</sub>	-	36	-		
Fall Time	T <sub>f</sub>	-	16	-		
Input Capacitance	C <sub>iss</sub>	-	500	800	pF	V <sub>GS</sub> =0V V <sub>DS</sub> =25V f=1.0MHz
Output Capacitance	C <sub>oss</sub>	-	90	-		
Reverse Transfer Capacitance	C <sub>rss</sub>	-	40	-		

**Source-Drain Diode**

Parameter	Symbol	Min.	Typ.	Max.	Unit	Test Conditions
Forward On Voltage <sup>3</sup>	V <sub>SD</sub>	-	-	1.3	V	I <sub>S</sub> =8.6A, V <sub>GS</sub> =0V
Reverse Recovery Time	T <sub>rr</sub>	-	225	-	ns	I <sub>S</sub> =8.6A, V <sub>GS</sub> =0V
Reverse Recovery Charge	Q <sub>rr</sub>	-	2260	-	nC	dI/dt=100A/μs

Notes: 1. Pulse width limited by safe operating area.

2. Staring T<sub>j</sub>=25°C, V<sub>DD</sub>=50V, L=1mH, R<sub>G</sub>=25Ω, I<sub>AS</sub>=8.6A.

3. Pulse width ≤ 300us, duty cycle ≤ 2%.

## Characteristics Curve

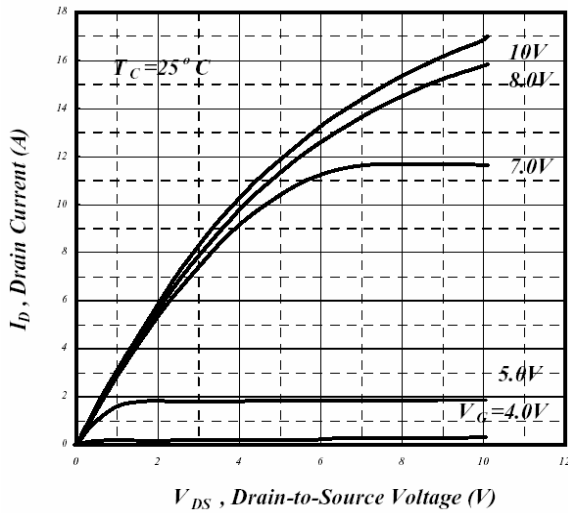

**Fig 1. Typical Output Characteristics**

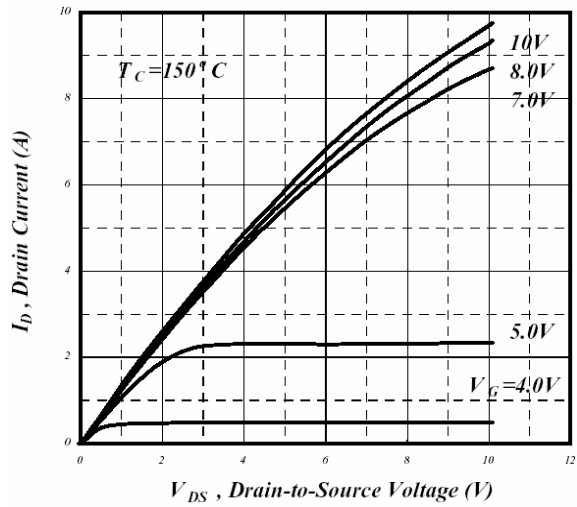

**Fig 2. Typical Output Characteristics**

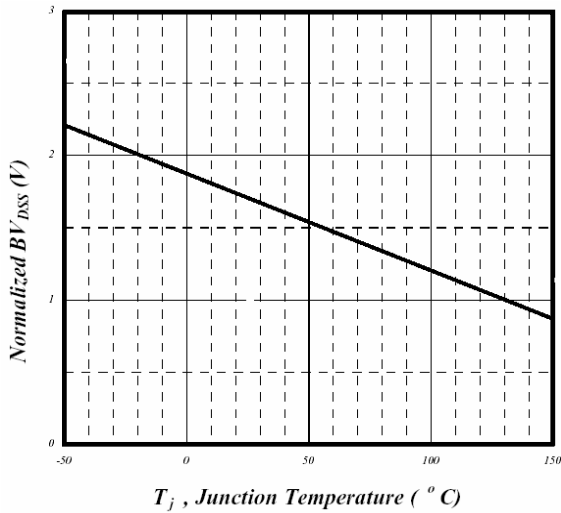

**Fig 3. Normalized  $BV_{DSS}$  v.s. Junction Temperature**

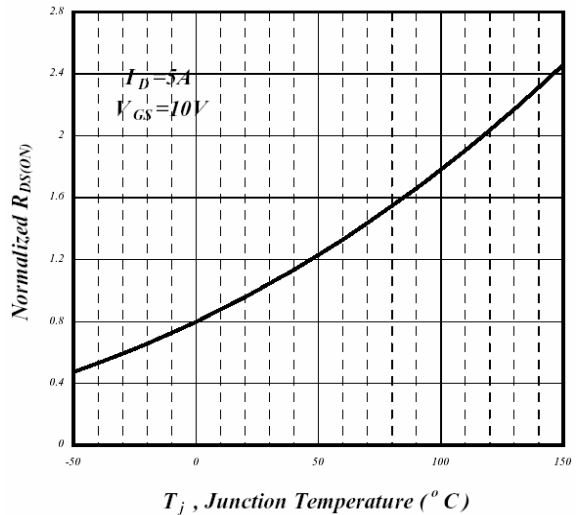

**Fig 4. Normalized On-Resistance v.s. Junction Temperature**

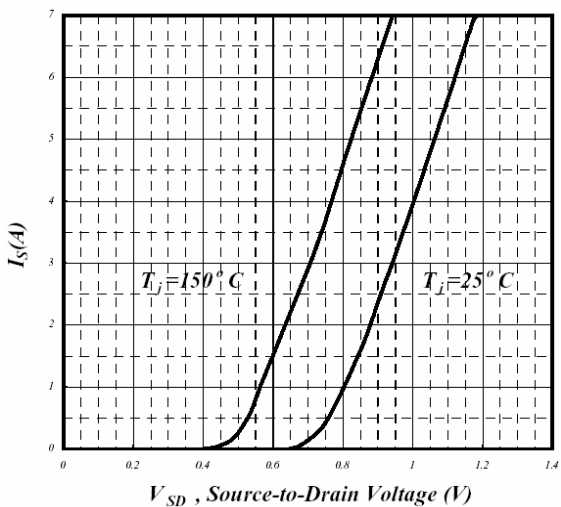

**Fig 5. Forward Characteristics of Reverse Diode**

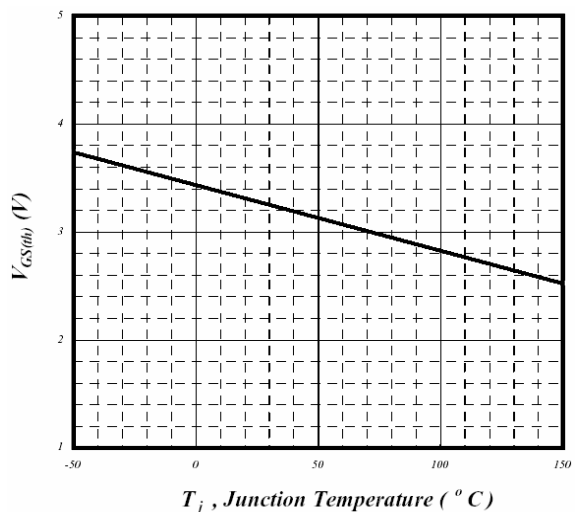

**Fig 6. Gate Threshold Voltage v.s. Junction Temperature**

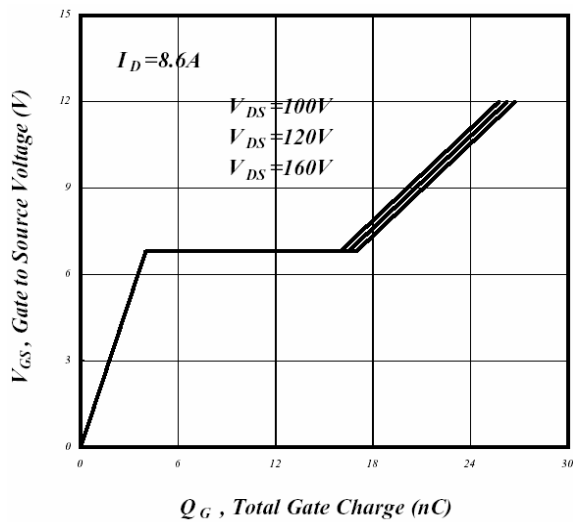

**Fig 7. Gate Charge Characteristics**

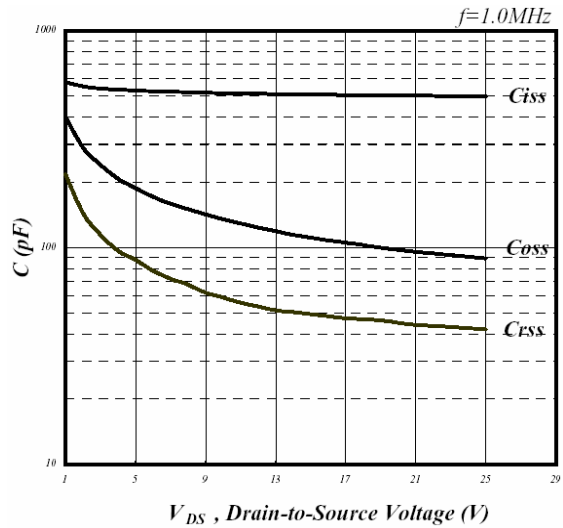

**Fig 8. Typical Capacitance Characteristics**

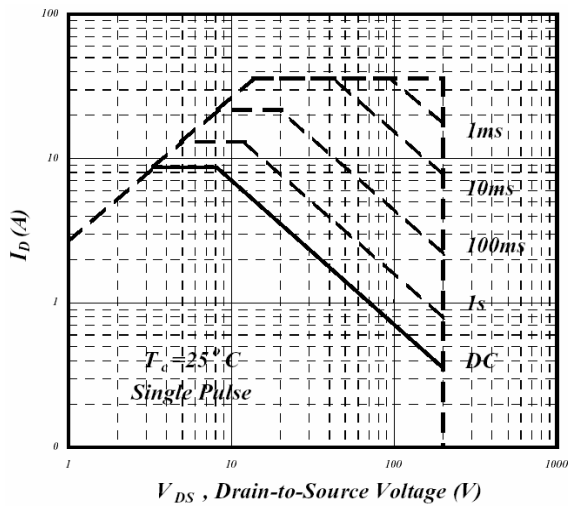

**Fig 9. Maximum Safe Operating Area**

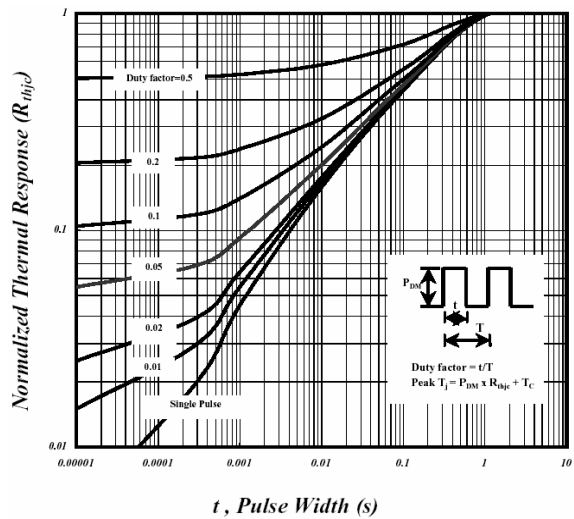

**Fig 10. Effective Transient Thermal Impedance**

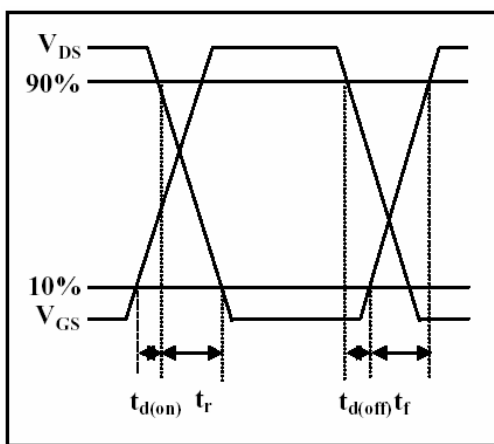

**Fig 11. Switching Time Waveform**

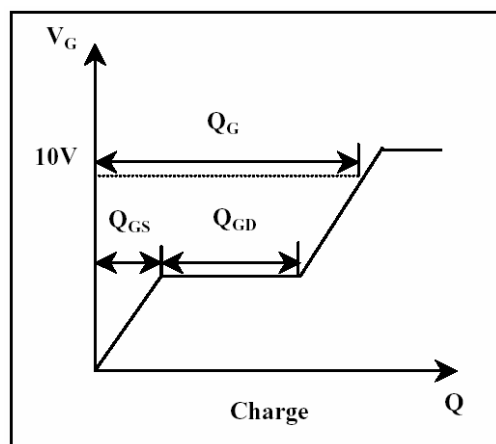

**Fig 12. Gate Charge Waveform**

**Important Notice:**

- All rights are reserved. Reproduction in whole or in part is prohibited without the prior written approval of GTM.
- GTM reserves the right to make changes to its products without notice.
- GTM semiconductor products are not warranted to be suitable for use in life-support Applications, or systems.
- GTM assumes no liability for any consequence of customer product design, infringement of patents, or application assistance.

**Head Office And Factory:**

- Taiwan:** No. 17-1 Tatung Rd. Fu Kou Hsin-Chu Industrial Park, Hsin-Chu, Taiwan, R. O. C.
- TEL : 886-3-597-7061 FAX : 886-3-597-9220, 597-0785
- China:** (201203) No.255, Jang-Jiang Tsai-Lueng RD. , Pu-Dung-Hsin District, Shang-Hai City, China
- TEL : 86-21-5895-7671 ~ 4 FAX : 86-21-38950165