

GL2□□6 series

ø2mm, Convex Type, Colored Diffusion LED Lamps for Indicator

■ Outline Dimensions

(Unit : mm)

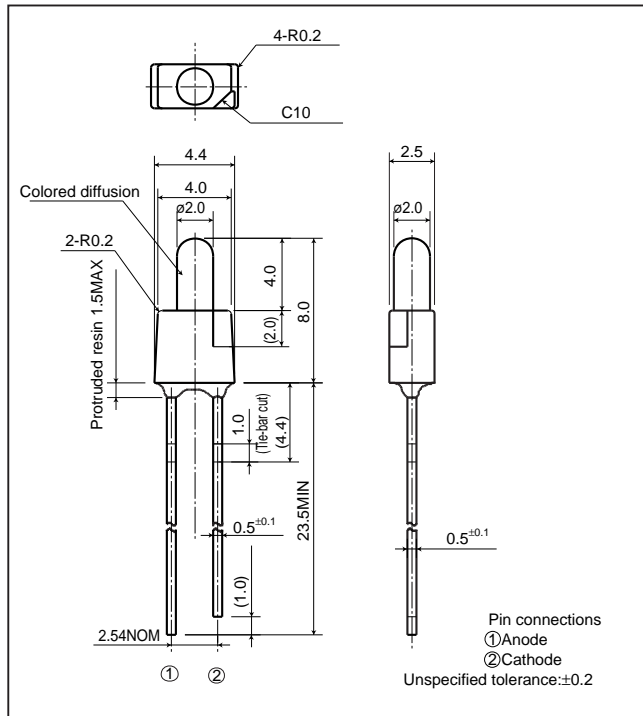

■ Absolute Maximum Ratings

(T_a=25°C)

Model No.	Radiation color	Radiation material	Power dissipation P (mW)	Forward current I _F (mA)	Peak forward current I _{FM} ^{*1} (mA)	Derating factor (mA/°C)		Reverse voltage V _R (V)	Operating temperature T _{opr} (°C)	Storage temperature T _{stg} (°C)	Soldering temperature T _{sol} ^{*2} (°C)
						DC	Pulse				
GL2PR6	Red	GaP	23	10	50	0.13	0.67	5	-25 to +85	-25 to +100	260
GL2HD6	Red	GaAsP on GaP	84	30	50	0.40	0.67	5	-25 to +85	-25 to +100	260
GL2HS6	Sunset orange	GaAsP on GaP	84	30	50	0.40	0.67	5	-25 to +85	-25 to +100	260
GL2HY6	Yellow	GaAsP on GaP	84	30	50	0.40	0.67	5	-25 to +85	-25 to +100	260
GL2EG6	Yellow-green	GaP	84	30	50	0.40	0.67	5	-25 to +85	-25 to +100	260

*1 Duty ratio=1/10, Pulse width=0.1ms

*2 5s or less(At the position of 1.6mm or more from the bottom face of resin package)

■ Electro-optical Characteristics

(T_a=25°C)

Lens type	Model No.	Forward voltage V _F (V)		Peak emission wavelength		Luminous intensity		Spectrum radiation bandwidth		Reverse current		Terminal capacitance		Page for characteristics diagrams
		TYP	MAX	λ _p (nm) TYP	I _F (mA)	I _v (mcd) TYP	I _F (mA)	Δλ(nm) TYP	I _F (mA)	I _R (μA) MAX	V _R (V)	C _t (pF) TYP	(MHz)	
Colored diffusion	GL2PR6	1.9	2.3	695	5	1.5	5	100	5	10	4	55	1	→
	GL2HD6	2.0	2.8	635	20	12	20	35	20	10	4	20	1	→
	GL2HS6	2.0	2.8	610	20	12	20	35	20	10	4	15	1	→
	GL2HY6	2.0	2.8	585	20	12	20	30	20	10	4	35	1	→
	GL2EG6	2.1	2.8	565	20	15	20	30	20	10	4	35	1	→

(Notice) • In the absence of confirmation by device specification sheets, SHARP takes no responsibility for any defects that may occur in equipment using any SHARP devices shown in catalogs, data books, etc. Contact SHARP in order to obtain the latest device specification sheets before using any SHARP device.

(Internet) • Data for sharp's optoelectronic/power device is provided for internet.(Address <http://www.sharp.co.jp/ecg/>)

LED Lamp Characteristics Diagrams

PR series



HD series



Note) Characteristics shown in diagrams are typical values. (not assurance value)

- (Notice) • In the absence of confirmation by device specification sheets, SHARP takes no responsibility for any defects that may occur in equipment using any SHARP devices shown in catalogs, data books, etc. Contact SHARP in order to obtain the latest device specification sheets before using any SHARP device.
 (Internet) • Data for sharp's optoelectronic/power device is provided for internet.(Address <http://www.sharp.co.jp/ecg/>)

LED Lamp Characteristics Diagrams

HS series

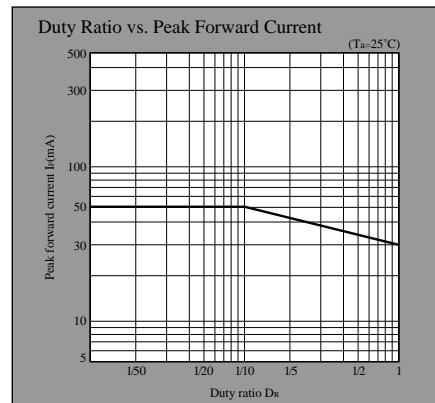
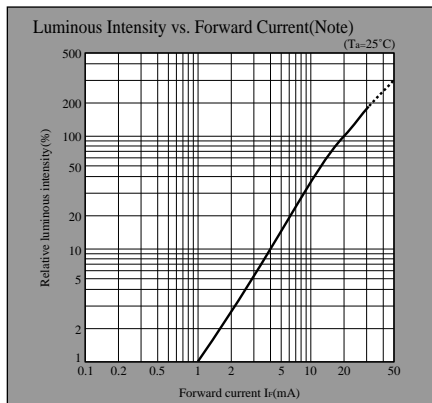
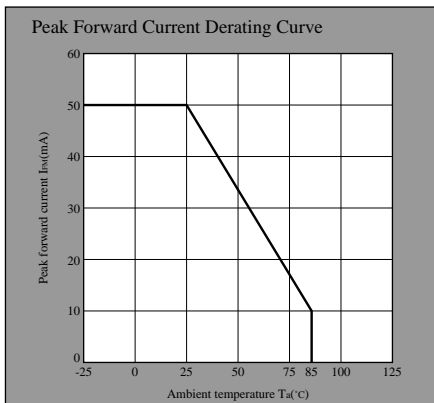
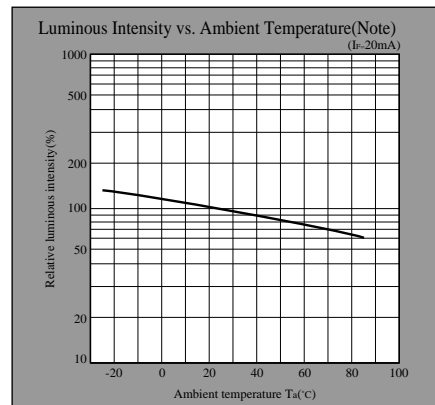
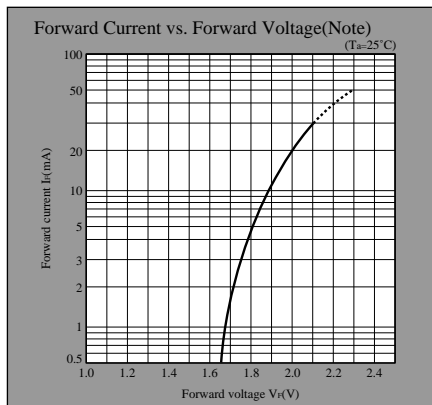
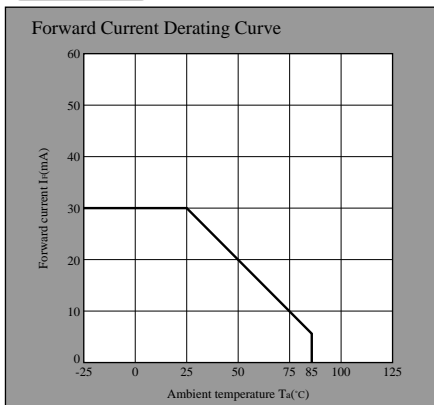

HY series

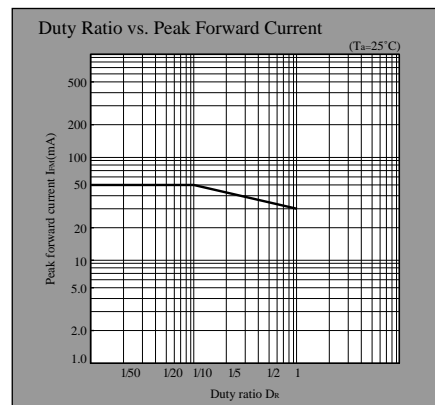
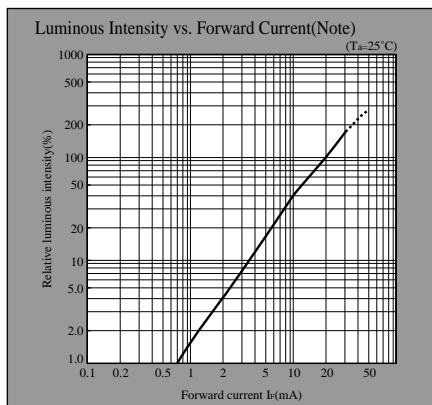
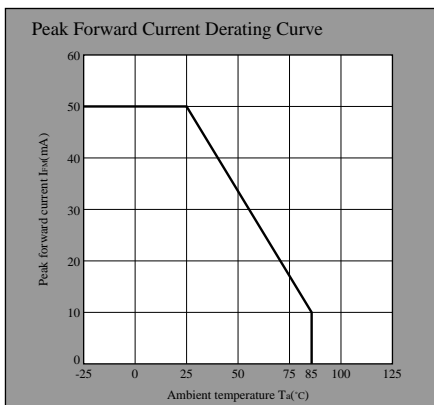
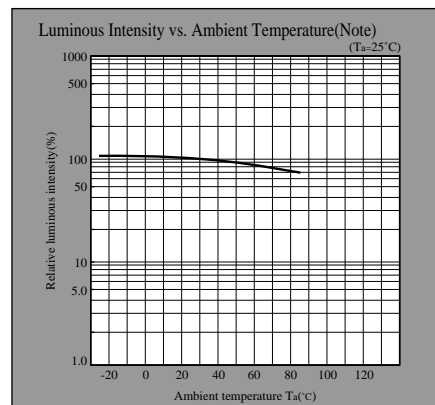
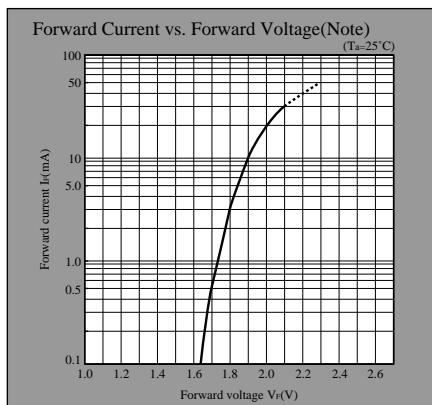
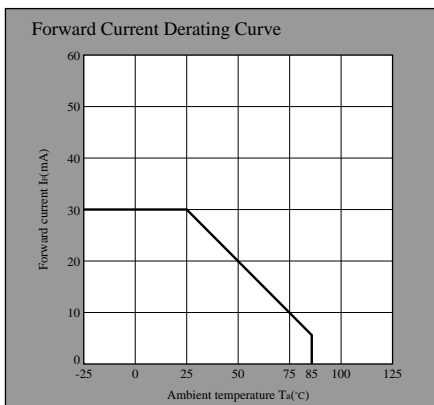

Note) Characteristics shown in diagrams are typical values. (not assurance value)

- (Notice) • In the absence of confirmation by device specification sheets, SHARP takes no responsibility for any defects that may occur in equipment using any SHARP devices shown in catalogs, data books, etc. Contact SHARP in order to obtain the latest device specification sheets before using any SHARP device.
 (Internet) • Data for sharp's optoelectronic/power device is provided for internet. (Address <http://www.sharp.co.jp/ecg/>)

Forward Current Derating Curve

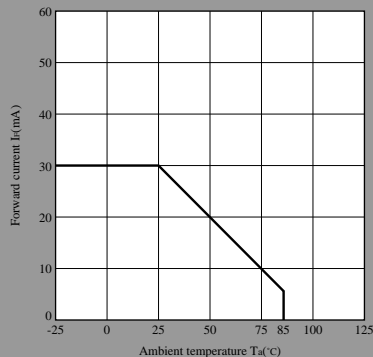

Forward Current vs. Forward Voltage(Note)

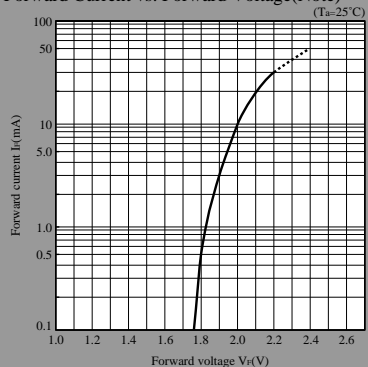

Luminous Intensity vs. Ambient Temperature(Note)

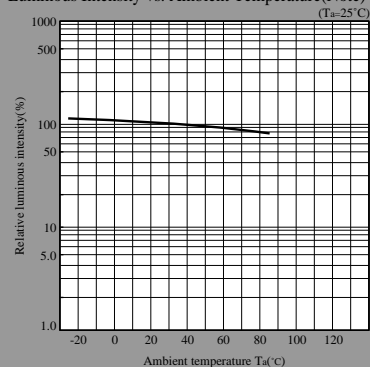

Peak Forward Current Derating Curve

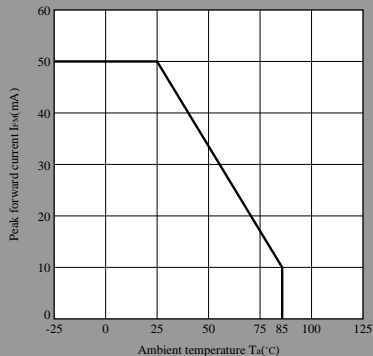

Luminous Intensity vs. Forward Current(Note)

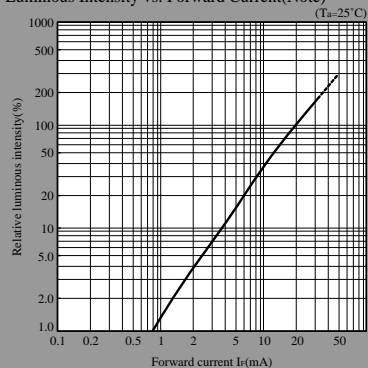

Duty Ratio vs. Peak Forward Current

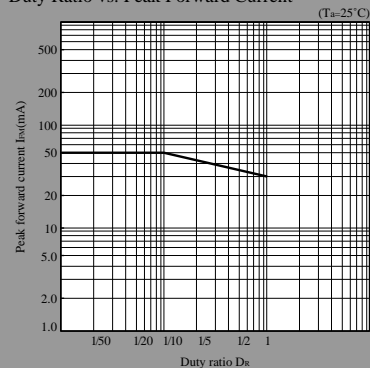

Note) Characteristics shown in diagrams are typical values. (not assurance value)