

# GL3□□43 Series $\phi$ 3mm(T-1) Cylinder Type LED Lamps

## Model No.

GL3UR43 Red (Super-luminosity)	GaAlAs/GaAlAs
GL3LR43 Red (High-luminosity)	GaAlAs/GaAs
GL3TR43 Red (High-luminosity)	GaAlAs/GaAs
GL3PR43 Red	GaP
GL3HD43 Red	GaAsP/GaP
GL3HS43 Sunset orange	GaAsP/GaP
GL3HY43 Yellow	GaAsP/GaP
GL3EG43 Yellow-green	GaP
GL3KG43 Green	GaP

## Outline Dimensions (Unit: mm)

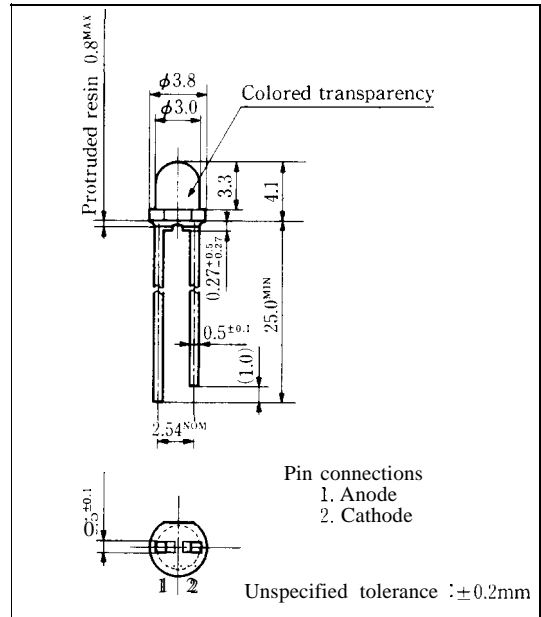

## Features

- $\phi$ 3mm(T-1) all resin mold
- Colored transparency lens type
- Wide viewing angle

## Absolute Maximum Ratings

(Ta = 25°C)

Parameter	Symbol	GL3UR43	GL3LR43	GL3PR43	GL3HD43	GL3EG43	Unit	
			GL3TR43		GL3HS43	GL3KG43		
					GL3HY43			
Power dissipation	P	75	110	23	84	84	mW	
Continuous forward current	I <sub>F</sub>	30	50	10	30	30	mA	
*1 Peak forward current	I <sub>FM</sub>	50	300	50	50	50	mA	
Derating factor	DC	—	0.40	0.67	0.13	0.40	0.40	mA/°C
	Pulse	—	0.67	4.00	0.67	0.67	0.67	mA/°C
Reverse voltage	V <sub>R</sub>	4	5	5	5	5	V	
Operating temperature	T <sub>opr</sub>	-25 to +85						°C
Storage temperature	T <sub>stg</sub>	-25 to +100						°C
*2 Soldering temperature	T <sub>sol</sub>	260(within 5 seconds)						°C

\*1 Duty ratio = 1/10, Pulse width = 0.1ms

Duty ratio = 1/16, Pulse width  $\leq$  1ms for GL3LR43 and GL3TR43

\*2 At the position of 1.6mm from the bottom face of resin package

SHARP

GL3UR43 (Red)

■ Electro-optical Characteristics

(Ta = 25°C)

Parameter	Symbol	Model No.	Conditions	MIN.	TYP.	MAX.	Unit
Forward voltage	$V_F$	GL3UR43	$I_F = 20\text{mA}$	-	185	2.5	V
*3 Luminous intensity	$I_v$	GL3UR43	$I_F = 20\text{mA}$	50	100	-	mcd
Peak emission wavelength	$\lambda_p$	GL3UR43	$I_F = 20\text{mA}$	-	660	-	nm
Spectrum radiation bandwidth	$\Delta\lambda$	GL3UR43	$I_F = 20\text{mA}$	-	20	-	nm
Reverse current	$I_R$	GL3UR43	$V_R = 3\text{V}$	-	-	100	$\mu\text{A}$
Terminal capacitance	$C_t$	GL3UR43	$V = 0\text{V}$ $f = \text{MHz}$	-	25	-	pF
Response frequency	$f_c$	GL3UR43	-	-	8	-	MHz

\*3 Tolerance:  $\pm 30\%$

■ Characteristics Diagrams

Forward Current vs. Forward Voltage (Ta = 25°C)

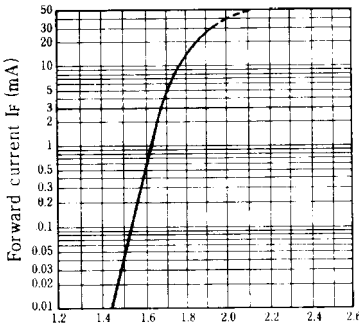

Forward voltage  $V_F$  (V)

Luminous Intensity vs. Forward Current (Ta = 25°C)

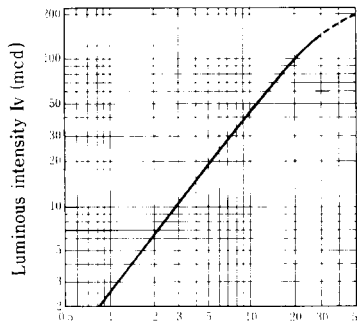

Forward current  $I_F$  (mA)

Forward Current Derating Curve

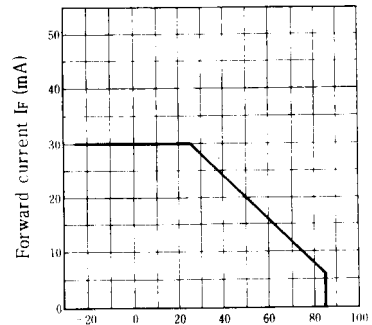

Ambient temperature  $T_a$  (°C)

Relative Luminous Intensity vs. Ambient Temperature (If = 20mA)

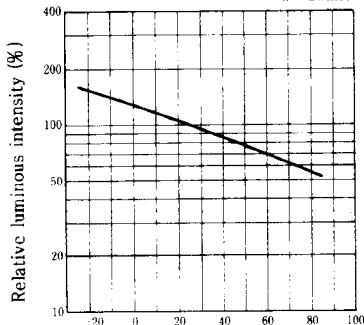

Ambient temperature  $T_a$  (°C)

Spectrum Distribution (Ta = 25°C)

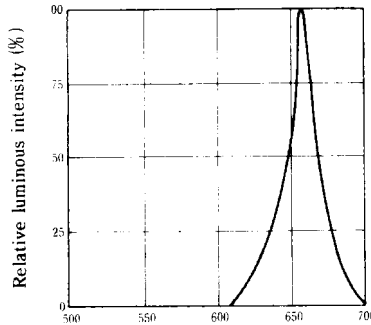

Wavelength  $\lambda$  (nm)

Radiation Diagram (Ta = 25°C)

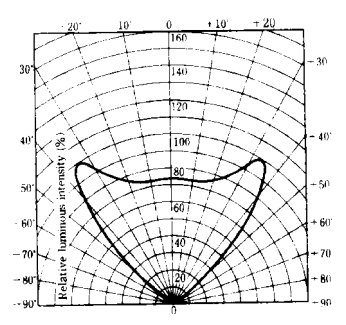

GL3LR43 (Red) / GL3TR43 (Red)

■ Electro-optical Characteristics

(Ta = 25°C)

Parameter	Symbol	Model No.	Conditions	MIN.	TYP.	MAX.	Unit
Forward voltage	V <sub>F</sub>	GL3LR43	I <sub>F</sub> = 20mA	—	1.75	2.2	V
		GL3TR43	I <sub>F</sub> = 20mA		1.75	2.2	
※3 Luminous intensity	I <sub>v</sub>	GL3LR43	I <sub>F</sub> = 20mA	20	40	—	‘cd
		GL3TR43	I <sub>F</sub> = 20mA	10	20	—	
Peak emission wavelength	λ <sub>p</sub>	GL3LR43	I <sub>F</sub> = 20mA	—	660	—	‘m
		GL3TR43	I <sub>F</sub> = 20mA		660	—	
Spectrum radiation bandwidth	Δλ	GL3LR43	I <sub>F</sub> = 20mA		20	—	‘m
		GL3TR43	I <sub>F</sub> = 20mA	—	20	—	
Reverse current	I <sub>R</sub>	GL3LR43	V <sub>R</sub> = 4V	—	—	10	μA
		GL3TR43	V <sub>R</sub> = 4V	—	—	10	
Terminal capacitance	C <sub>t</sub>	GL3LR43	V = 0V f = 1 MHz	—	30	—	pF
		GL3TR43	V = 0V f = 1 MHz	—	30	—	
Response frequency	f <sub>c</sub>	GL3LR43	—	—	8	—	MHz
		GL3TR43	—	—	8	—	

※3 Tolerance: ±30%

■ Characteristics Diagrams

Forward Current vs. Forward Voltage

(Ta = 25°C)

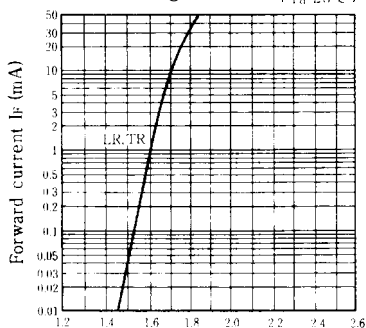

Forward voltage V<sub>F</sub> (V)

Luminous Intensity vs. Forward Current

(Ta = 25°C)

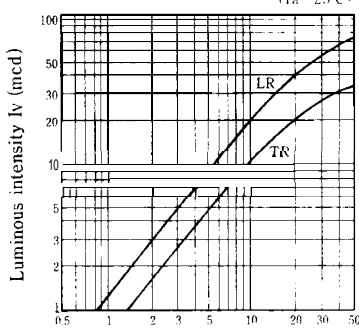

Forward current I<sub>F</sub> (mA)

Forward Current Derating Curve

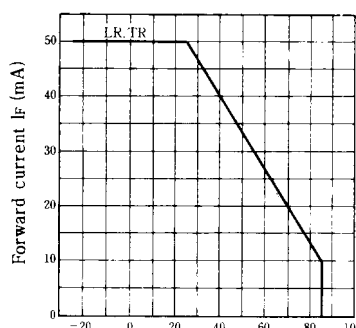

Ambient temperature, Ta (°C)

Relative Luminous Intensity vs. Ambient Temperature

(I<sub>F</sub> = 20mA)

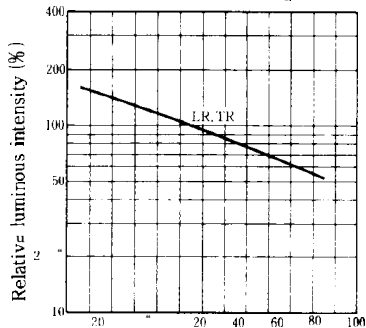

Ambient temperature Ta (°C)

Spectrum Distribution

(Ta = 25°C)

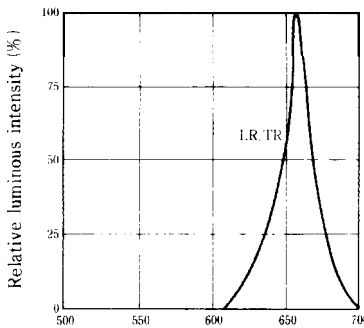

Wavelength λ (nm)

Radiation Diagram

(Ta = 25°C)

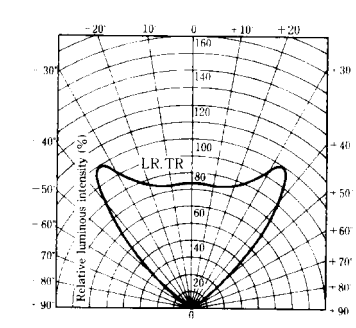

## GL3PR43 (Red) / GL3HD43 (Red)

■ **Electro-optical** Characteristics

(Ta = 25°C)

Parameter	Symbol	Model No.	Conditions	MIN.	TYP.	MAX.	Unit
Forward voltage	V <sub>F</sub>	GL3PR43	I <sub>F</sub> = 5mA	—	1.9	2.3	V
		GL3HD43	I <sub>F</sub> = 20mA	—	2.0	2.8	
※3 Luminous intensity	I <sub>v</sub>	GL3PR43	I <sub>F</sub> = 5mA	1.0	3.0	—	mcd
		GL3HD43	I <sub>F</sub> = 20mA	7.0	25	—	
Peak emission wavelength	λ <sub>p</sub>	GL3PR43	I <sub>F</sub> = 5mA	—	695	—	‘m
		GL3HD43	I <sub>F</sub> = 20mA	—	635	—	
Spectrum radiation bandwidth	Δλ	GL3PR43	I <sub>F</sub> = 5mA	—	100	—	‘m
		GL3HD43	I <sub>F</sub> = 20mA	—	35	—	
Reverse current	I <sub>R</sub>	GL3PR43	V <sub>R</sub> = 4V	—	—	10	μA
		GL3HD43	V <sub>R</sub> = 4V	—	—	10	
Terminal capacitance	C <sub>t</sub>	GL3PR43	V = 0V f = 1MHz	—	55	—	pF
		GL3HD43	V = 0V f = 1MHz	—	20	—	
Response frequency	f <sub>c</sub>	GL3PR43	—	—	4	—	MHz
		GL3HD43	—	—	4	—	

※3 Tolerance: ±30%

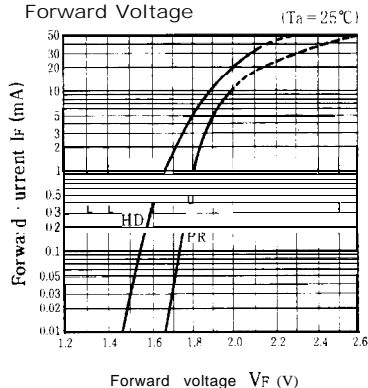
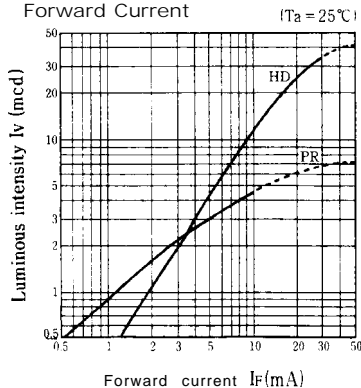
■ **Characteristics Diagrams**Forward Current vs.  
Forward VoltageLuminous Intensity vs.  
Forward Current

Forward Current Derating Curve

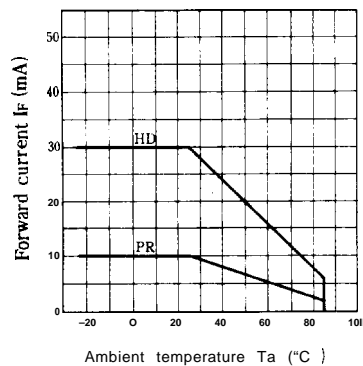
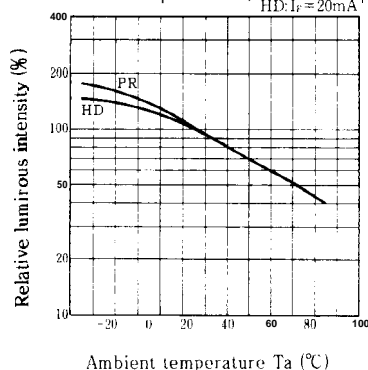
Relative Luminous Intensity vs.  
Ambient Temperature, PR: I<sub>F</sub> = 5mA  
HD: I<sub>F</sub> = 20mA

Spectrum Distribution

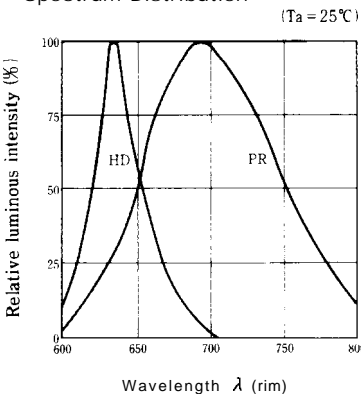

Radiation Diagram

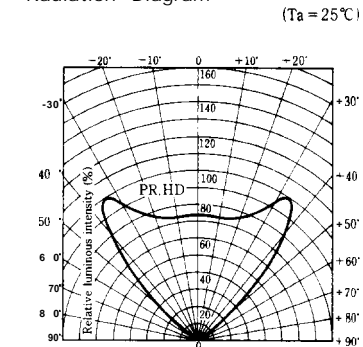

GL3HS43 (Sunset orange) / GL3HY43 (Yellow)

■ **Electro-optical** Characteristics

(Ta = 25°C)

Parameter	Symbol	Model No.	Conditions	MIN.	TYP.	MAX.	Unit
Forward voltage	V <sub>F</sub>	GL3HS43	I <sub>F</sub> = 20mA	—	2.0	2.8	V
		GL3HY43	I <sub>F</sub> = 20mA	—	2.0	2.8	
*3 Luminous intensity	I <sub>v</sub>	GL3HS43	I <sub>F</sub> = 20mA	7.0	25	—	'cd
		GL3HY43	I <sub>F</sub> = 20mA	7.0	25	—	
Peak emission wavelength	λ <sub>p</sub>	GL3HS43	I <sub>F</sub> = 20mA	—	610	—	'm
		GL3HY43	I <sub>F</sub> = 20mA	—	585	—	
Spectrum radiation bandwidth	Δλ	GL3HS43	I <sub>F</sub> = 20mA	—	35	—	'm
		GL3HY43	I <sub>F</sub> = 20mA	—	30	—	
Reverse current	I <sub>R</sub>	GL3HS43	V <sub>R</sub> = 4V	—	—	10	μA
		GL3HY43	V <sub>R</sub> = 4V	—	—	10	
Terminal capacitance	C <sub>t</sub>	GL3HS43	V = 0V f = 1 MHz	—	15	—	pF
		GL3HY43	V = 0V f = 1 MHz	—	35	—	
Response frequency	f <sub>c</sub>	GL3HS43	—	—	4	—	'Hz
		GL3HY43	—	—	4	—	

\*3 Tolerance: ±30%

3

■ **Characteristics Diagrams**

Forward Current vs. Forward Voltage (Ta = 25°C)

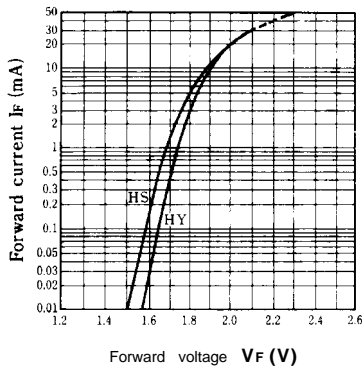

Luminous Intensity vs. Forward Current (Ta = 25°C)

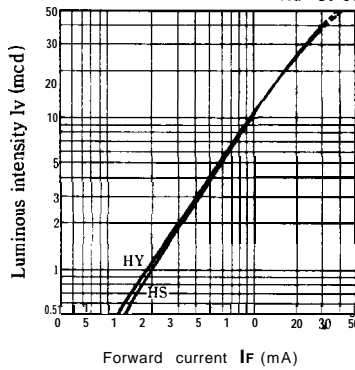

Forward Current Derating Curve

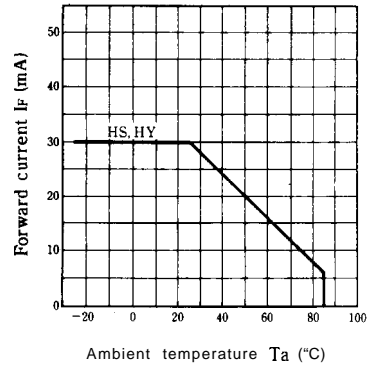

Relative Luminous Intensity vs. Ambient Temperature (If = 20mA)

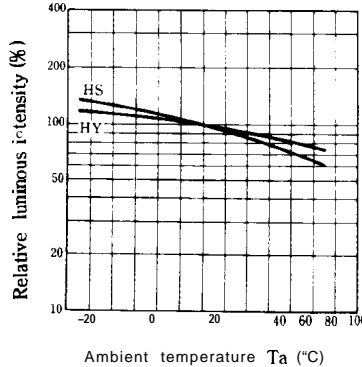

Spectrum Distribution (Ta = 25°C)

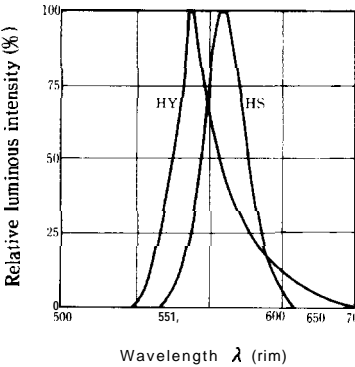

Radiation Diagram (Ta = 25°C)

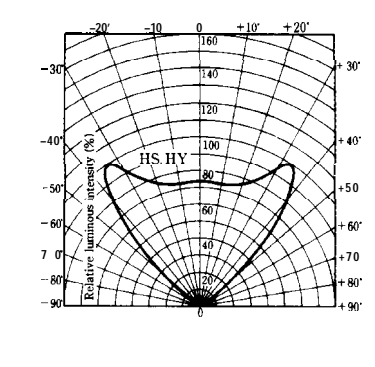

GL3EG43 (Yellow-green) / GL3KG43 (Green)

■ Electro-optical Characteristics

(Ta = 25°C)

Parameter	Symbol	Model No.	Conditions	MIN.	TYP.	MAX.	Unit
Forward voltage	V <sub>F</sub>	GL3EG43	I <sub>F</sub> = 20mA		2.1	2.8	V
		GL3KG43	I <sub>F</sub> = 20mA	-	2.1	2.8	
※3 Luminous intensity	I <sub>v</sub>	GL3EG43	I <sub>F</sub> = 20mA	10	25	-	'cd
		GL3KG43	I <sub>F</sub> = 20mA	8.0	20	-	
Peak emission wavelength	λ <sub>p</sub>	GL3EG43	I <sub>F</sub> = 20mA	-	565	-	nm
		GL3KG43	I <sub>F</sub> = 20mA	-	555	-	
Spectrum radiation bandwidth	Δλ	GL3EG43	I <sub>F</sub> = 20mA	-	30	-	'm
		GL3KG43	I <sub>F</sub> = 20mA	-	25	-	
Reverse current	I <sub>R</sub>	GL3EG43	V <sub>R</sub> = 4V	-	-	10	μA
		GL3KG43	V <sub>R</sub> = 4V	-	-	10	
Terminal capacitance	C <sub>t</sub>	GL3EG43	V = 0V f = 1MHz	-	35	-	pF
		GL3KG43	V = 0V f = 1MHz	-	40	-	
Response frequency	f <sub>c</sub>	GL3EG43	-	-	4	-	MHz
		GL3KG43	-	-	4	-	

※3 Tolerance: ±30%

■ Characteristics Diagrams

Forward Current vs. Forward Voltage (Ta = 25°C)

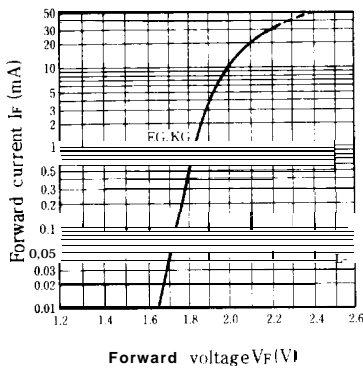

Luminous Intensity vs. Forward Current (Ta = 25°C)

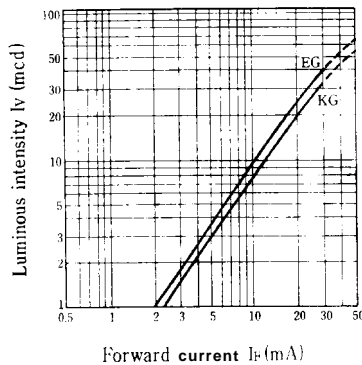

Forward Current Derating Curve

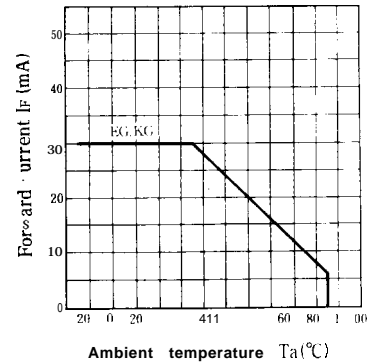

Relative Luminous Intensity vs. Ambient Temperature (If = 20mA)

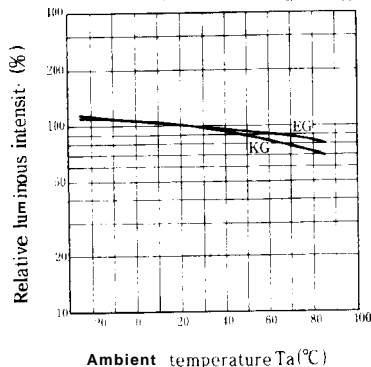

Spectrum Distribution (Ta = 25°C)

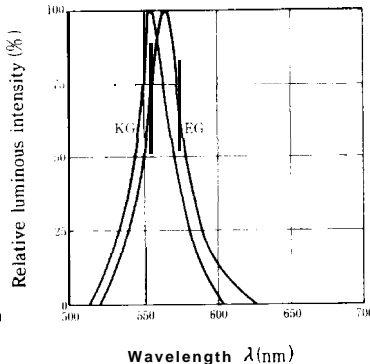

Radiation Diagram (Ta = 25°C)

