

GL453/GL454

Bidirectional Emission Type Infrared Emitting Diode

■ Features

1. Bidirectional light emission type
2. High output (Φ_e : TYP. 1.3mW at $I_F=20\text{mA}$)
3. Compact package type
4. Long lead pin type (**GL454**)
5. Epoxy resin package

■ Applications

1. Light source for tape-end detectors of VHS type VCRs

■ Outline Dimensions

(Unit : mm)

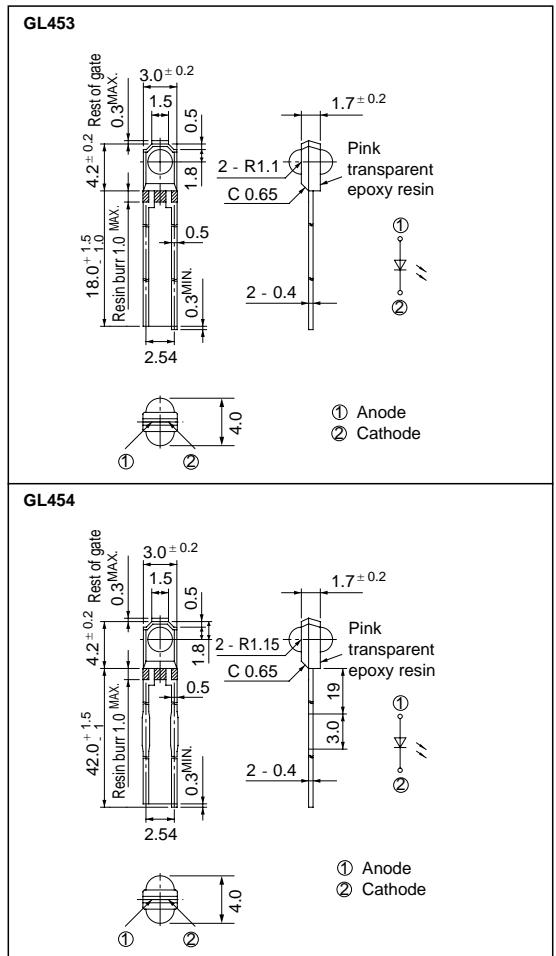

■ Absolute Maximum Ratings

(Ta = 25°C)

Parameter	Symbol	Rating	Unit
Power dissipation	P	75	mW
Forward current	I _F	50	mA
*1 Peak forward current	I _{FM}	1	A
Reverse voltage	V _R	6	V
Operating temperature	T _{opr}	- 25 to + 85	°C
Storage temperature	T _{stg}	- 40 to + 85	°C
*2 Soldering temperature	T _{sol}	260	°C

*1 Pulse width ≤ 100 μs, Duty ratio = 0.01

*2 For 3 seconds at the position of 1.8mm from the bottom face of resin package

Electro-optical Characteristics

($T_a = 25^\circ\text{C}$)

Parameter	Symbol	Conditions	MIN.	TYP.	MAX.	Unit
Forward voltage	V_F	$I_F = 20\text{mA}$	-	1.2	1.5	V
Peak forward voltage	V_{FM}	$I_{FM} = 0.5\text{A}$	-	3.0	4.0	V
Reverse current	I_R	$V_R = 3\text{V}$	-	-	10	μA
Terminal capacitance	C_t	$V = 0, f = 1\text{MHz}$	-	30	-	pF
Radiant flux	Φ_e	$I_F = 20\text{mA}$	0.85	1.3	1.95	mW
Peak emission wavelength	λ_p	$I_F = 5\text{mA}$	-	950	-	nm
Half intensity wavelength	$\Delta\lambda$	$I_F = 5\text{mA}$	-	45	-	nm

Fig. 1 Forward Current vs. Ambient Temperature

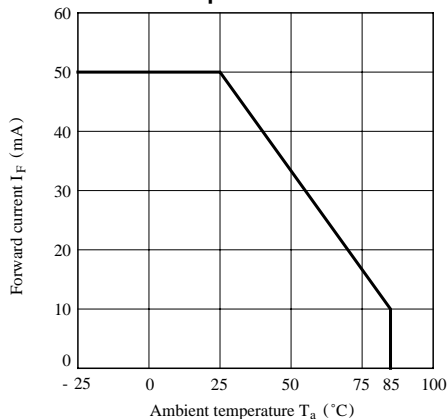

Fig. 2 Peak Forward Current vs. Duty Ratio

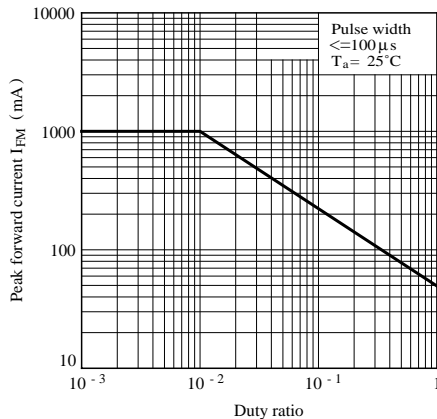

Fig. 3 Spectral Distribution

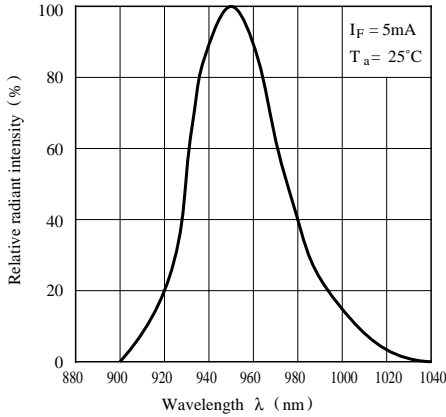

Fig. 4 Peak Emission Wavelength vs. Ambient Temperature

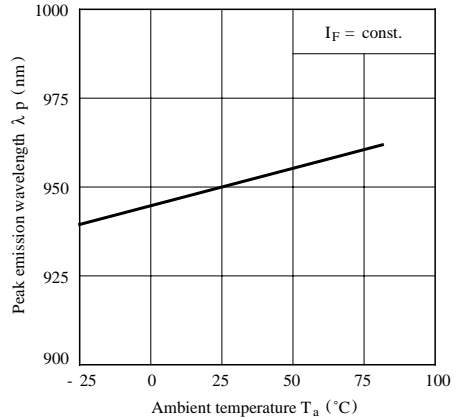

Fig. 5 Forward Current vs. Forward Voltage

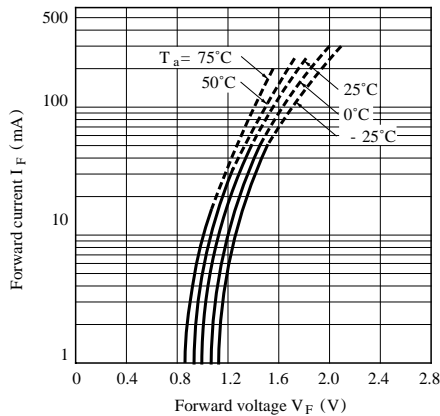

Fig. 6 Relative Radiant Flux vs. Ambient Temperature

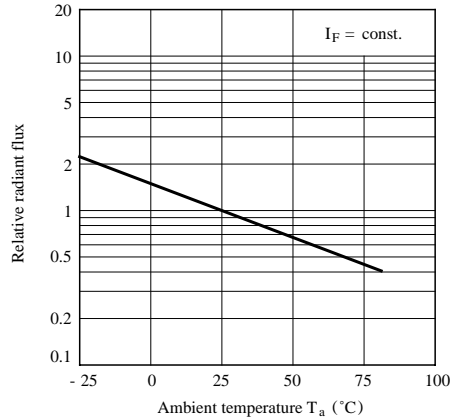

Fig. 7 Relative Radiant Flux vs. Peak Forward Current

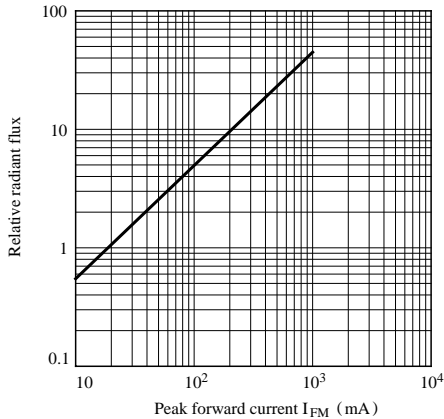

Fig. 8 Relative Radiant Intensity vs. Distance

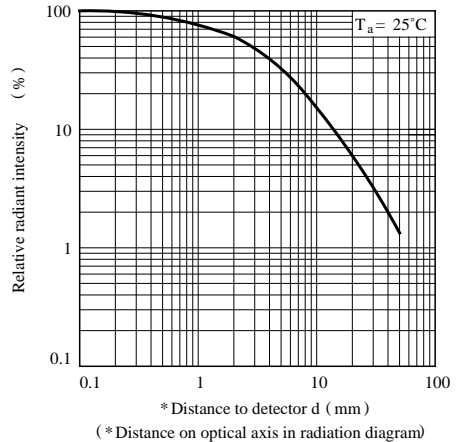
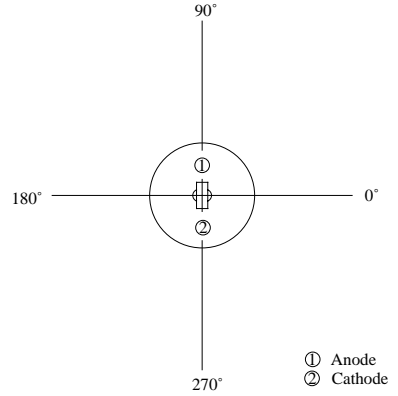
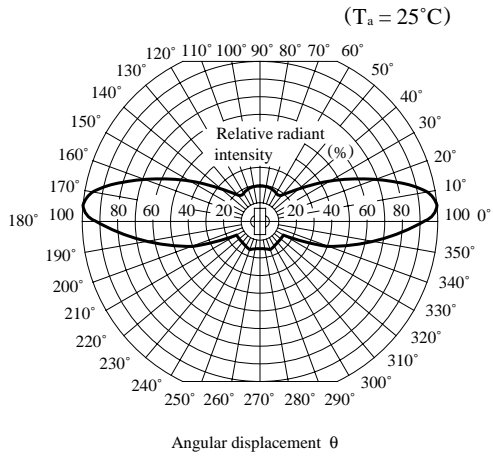

Fig. 9 Radiation Diagram



● Please refer to the chapter “Precautions for Use.”