

GL537/GL538

φ 5mm Resin Mold Type Infrared Emitting Diode

■ Features

1. High output power
I_E: TYP. 30mW/sr at I_F = 50mA (**GL538**)
2. Beam angle
GL538 Δθ : TYP. ± 13°
GL537 Δθ : TYP. ± 25°
3. φ 5mm epoxy resin package

■ Applications

1. Infrared remote controllers for TVs, VCRs, audio equipment and air conditioners

■ Absolute Maximum Ratings (Ta = 25°C)

Parameter	Symbol	Rating	Unit
Power dissipation	P	150	mW
Forward current	I _F	100	mA
*1 Peak forward current	I _{FM}	1	A
Reverse voltage	V _R	6	V
Operating temperature	T _{opr}	- 25 to + 85	°C
Storage temperature	T _{stg}	- 40 to + 85	°C
*2 Soldering temperature	T _{sol}	260	°C

*1 Pulse width ≤ 100 μ s, Duty ratio = 0.01

*2 For 3 seconds at the position of 2.6mm from the bottom face of resin package.

■ Electro-optical Characteristics (Ta = 25°C)

Parameter	Symbol	Conditions	MIN.	TYP.	MAX.	Unit
Forward voltage	V _F	I _F = 50mA	-	1.3	1.5	V
Peak forward voltage	V _{FM}	I _{FM} = 0.5A	-	1.9	3.0	V
Reverse current	I _R	V _R = 3V	-	-	10	μ A
Peak emission wavelength	λ _p	I _F = 5mA	-	950	-	nm
Half intensity wavelength	Δλ	I _F = 5mA	-	45	-	nm
*3 Radiation intensity	GL537	I _E = 50mA	6	13	-	mW/sr
	GL538		15	30	-	
Terminal capacitance	C _t	V _R = 0, f = 1kHz	-	50	-	pF
Response frequency	f _c	-	-	300	-	kHz
Half intensity angle	GL537	I _F = 20mA	-	± 25	-	°
	GL538		-	± 13	-	

*3 I_E : Value obtained by converting the value in power of radiant fluxes emitted at the solid angle of 0.01 sr (steradian) in the direction of mechanical axis of the lens portion into 1 sr of all those emitted from the light emitting diode.

■ Outline Dimensions (Unit : mm)

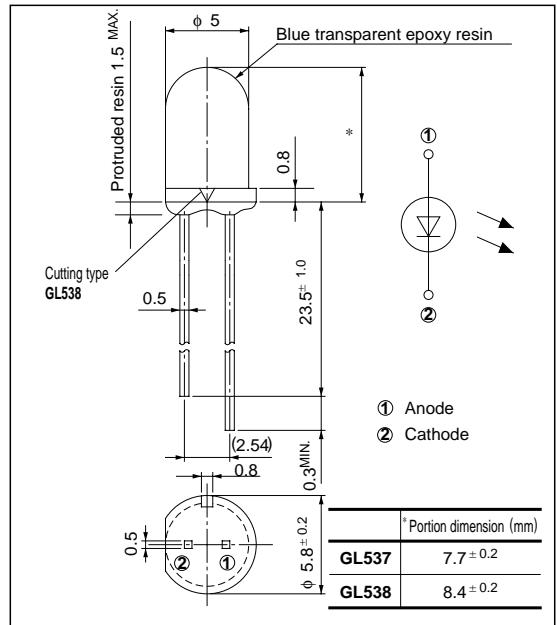

Fig. 1 Forward Current vs. Ambient Temperature

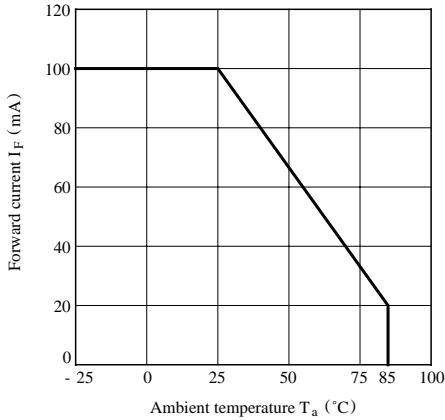

Fig. 2 Peak Forward Current vs. Duty Ratio

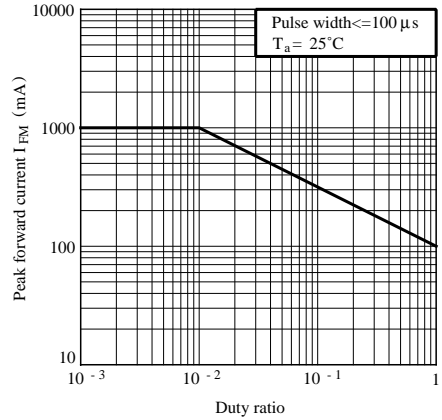

Fig. 3 Spectral Distribution

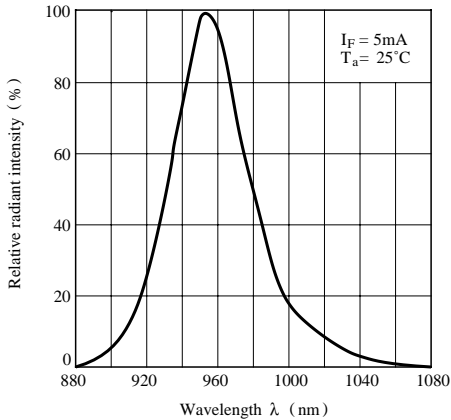

Fig. 4 Peak Emission Wave length vs. Ambient Temperature

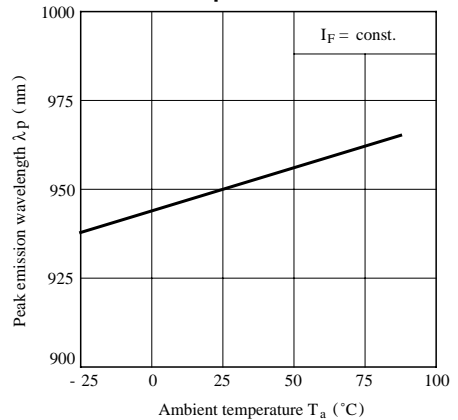

Fig. 5 Forward Current vs. Forward Voltage

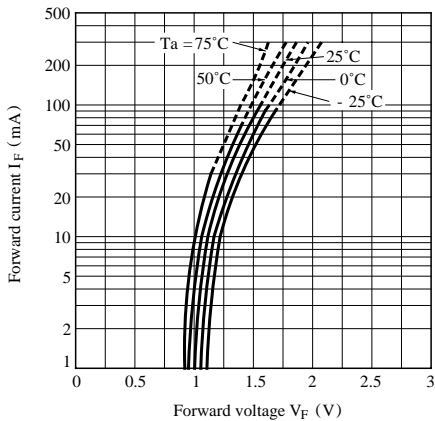

Fig. 6 Relative Forward Voltage vs. Ambient Temperature

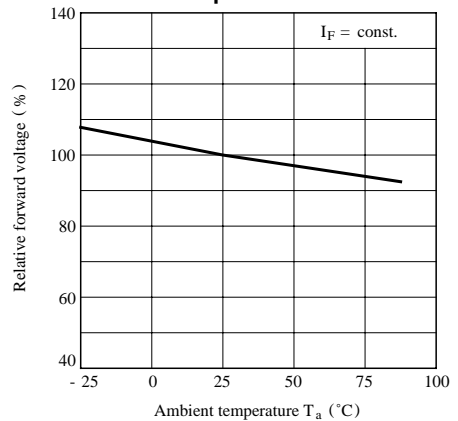

Fig. 7 Relative Output vs. Ambient Temperature (Detector : PD410PI)

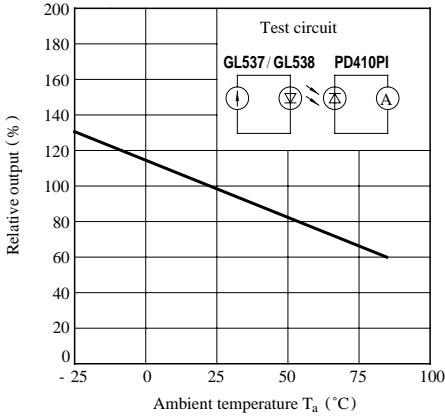

Fig. 8 Radiation Intensity vs. Peak Forward Current

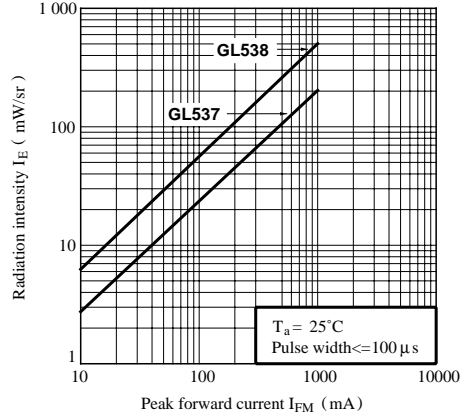

Fig. 9 Relative Collector Current vs. Distance (Detector : PD410PI)

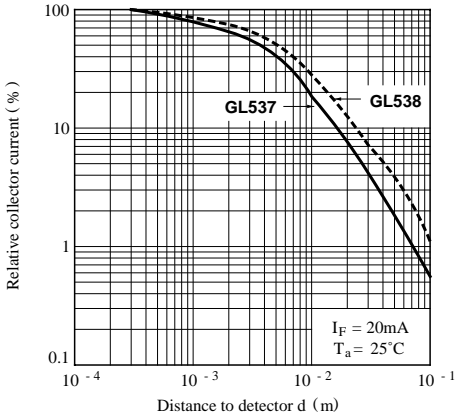

Fig.10 Relative Collector Current vs. Distance (Detector : PD49PI)

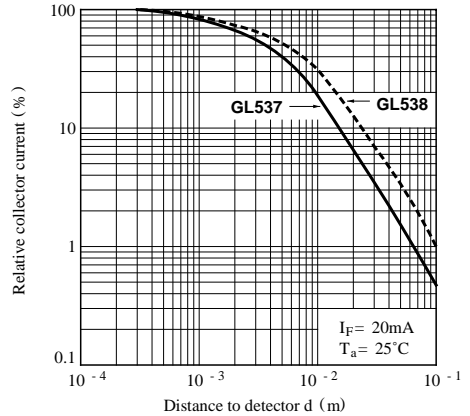

Fig.11-a Radiation Diagram (GL537) ($T_a = 25^\circ\text{C}$)

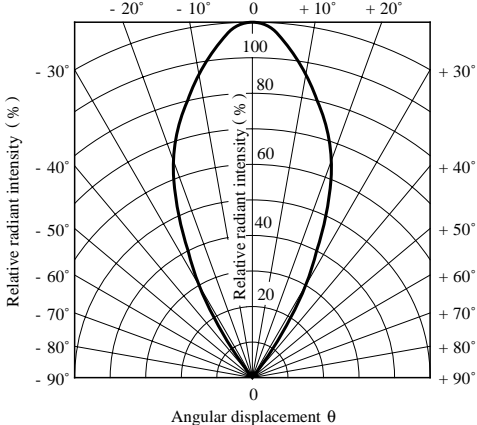

Fig.11-b Radiation Diagram (GL538) ($T_a = 25^\circ\text{C}$)

