

GM2116

CMOS Positive Voltage Regulator

Description

The GM2116 series of positive, linear regulators feature low quiescent current (30µA typ.) with low dropout voltage, making them ideal for battery applications.

These rugged devices have both Thermal Shutdown, and Current Fold-back to prevent device failure under the "Worst" of operating conditions.

The GM2116 is stable with an output capacitance of 2.2µF or greater.

Features

- Very Low Dropout Voltage
- Guaranteed 600mA output
- Over-Temperature Shutdown
- Current Limiting
- Short Circuit Current Fold-back
- Factory Pre-set Output Voltage
- Highly Accurate ± 1.5%
- Low Temperature Coefficient

Applications

- Battery Powered Widgets
- Instrumentation
- Wireless Devices
- Cordless Phones
- PC Peripherals
- Portable Electronics
- Electronic Scales

Block Diagram

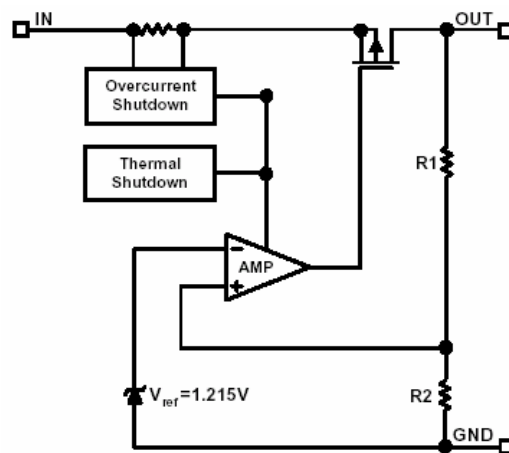

Package Dimensions

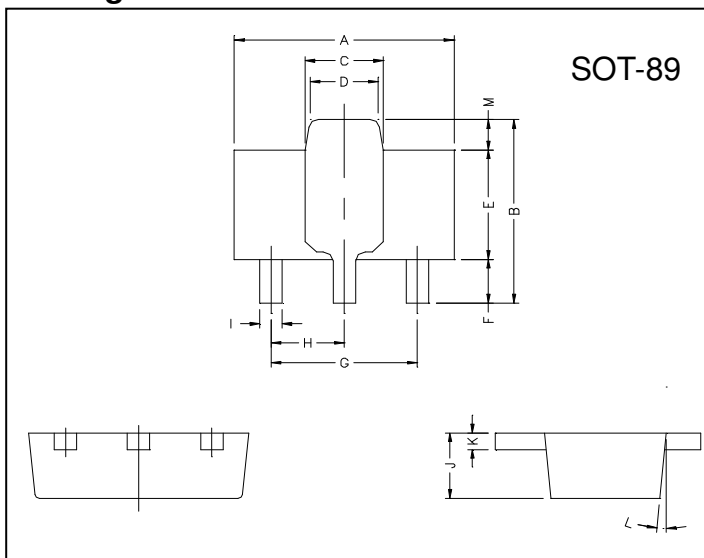

Marking :

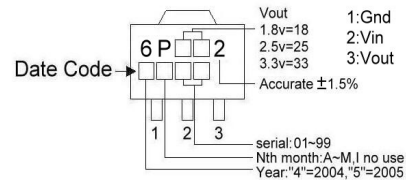

REF.	Millimeter		REF.	Millimeter	
	Min.	Max.		Min.	Max.
A	4.4	4.6	G	3.00	REF.
B	4.05	4.25	H	1.50	REF.
C	1.50	1.70	I	0.40	0.52
D	1.30	1.50	J	1.40	1.60
E	2.40	2.60	K	0.35	0.41
F	0.89	1.20	L	5°	TYP.
			M	0.70	REF.

Typical Application Circuit

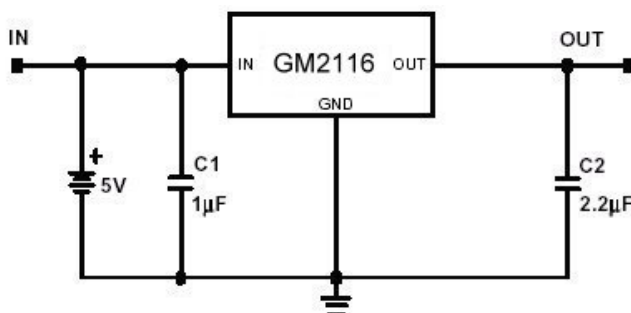

Absolute Maximum Ratings

Parameter	Symbol	Ratings	Unit
Input Max Voltage	V _{IN}	8	V
Output Current	I _{OUT}	1	A
Output Voltage	V _{OUT}	1.3~3.8	V
Supply Voltage	V _{IN}	4.5~5.5	V
Operating Ambient Temperature	T _{opr}	-40 ~ +85	°C
Junction Temperature	T _j	-40 ~ +125	°C
Maximum Junction Temperature	T _{j Max}	150	°C
Thermal Resistance	θ _{jc}	18	°C/W
	θ _{ja}	180	°C/W
Power Dissipation(ΔT=100°C)	PD	550	mW
EDS Classification		B	

Electrical Characteristics Ta=25°C unless otherwise noted

Parameter	Symbol	Condition	Min	TYP	Max	Unit	
Output Voltage	V _{OUT(E)} (Note1)	V _{IN} =V _{OUT(T)} +1V, I _o =1mA	-1.5%	V _{OUT(T)} (Note2)	1.5%	V	
Output Current	I _o	V _{IN} =V _{OUT(T)} +2V, V _{OUT} ≥V _{OUT(E)} *0.96	600	-	-	mA	
Current Limit	I _{LIM}	V _o >1.2V	600	800	-	mA	
Load Regulation	REG _{LOAD}	V _{IN} =V _{OUT(T)} +2V, I _o =1mA to 600mA	-	0.2	1	%	
Dropout Voltage	V _{DROPOUT}	I _o =600mA V _o =V _{OUT(E)} -2%	1.3V ≤ V _{OUT(T)} ≤ 1.4V	-	-	1900	mV
			1.4V < V _{OUT(T)} ≤ 2.0V	-	-	1400	
			2.0V < V _{OUT(T)} ≤ 2.8V	-	-	800	
			2.8V < V _{OUT(T)}	-	-	600	
Quiescent Current	I _q	V _{IN} =V _{OUT(T)} +1V, I _o =0mA	-	30	50	μA	
Line Regulation	REG _{LINE}	I _o =1mA V _{IN} =V _{OUT(T)} +1 to V _{OUT(T)} +2	1.3V ≤ V _{OUT(T)} ≤ 1.4V	-0.2	-	0.2	%
			1.4V < V _{OUT(T)} ≤ 2.0V	-0.15	-	0.15	
			2.0V < V _{OUT(T)} < 4.0V	-0.1	0.02	0.1	
			4.0V ≤ V _{OUT(T)}	-0.4	0.2	0.4	
Input Voltage	V _{IN}		Note3	-	7	V	
Over Temperature Shutdown	OTS		-	150	-	°C	
Over Temperature Hysterisis	OTH		-	30	-	°C	
Output Voltage Temperature Coefficient	TC		-	30	-	ppm/°C	
Short Circuit Current(Note4)	I _{SC}	V _{IN} =V _{OUT(T)} +1V, V _{OUT} <0.8V	-	300	600	mA	
Power Supply Rejection	PSRR	I _o =100mA C _o =2.2μF	f=100Hz	-	60	-	dB
			f=1kHz	-	50	-	
			f=10kHz	-	20	-	
Output Voltage Noise	e _N	f=10Hz~100kHz I _o =10mA, C _{BYP} =0μF				μVrms	

Note 1: V_{OUT(E)} =Effective Output Voltage (i.e. the output voltage when "V_{OUT(T)} + 1.0V" is provided at the V_{IN} pin while maintaining a certain I_{OUT} value).

2: V_{OUT(T)} =Specified Output Voltage

3: V_{IN(MIN)} =V_{OUT}+V_{DROPOUT}

4: To prevent the Short Circuit Current protection feature from being prematurely activated, the input voltage must be applied before a current source load is applied.

Ordering Information (contd.)

Part Number	Marking	Output Voltage	Part Number	Marking	Output Voltage
GM2116-13	6P132 XXXX	1.3V	GM2116-15	6P152 XXXX	1.5V
GM2116-18	6P182 XXXX	1.8V	GM2116-19	6P192 XXXX	1.9V
GM2116-20	6P202 XXXX	2.0V	GM2116-25	6P252 XXXX	2.5V
GM2116-27	6P272 XXXX	2.7V	GM2116-28	6P282 XXXX	2.8V
GM2116-29	6P292 XXXX	2.9V	GM2116-30	6P302 XXXX	3.0V
GM2116-31	6P312 XXXX	3.1V	GM2116-33	6P332 XXXX	3.3V
GM2116-34	6P342 XXXX	3.4V	GM2116-35	6P352 XXXX	3.5V
GM2116-36	6P362 XXXX	3.6V	GM2116-37	6P372 XXXX	3.7V
GM2116-38	6P382 XXXX	3.8V	GM2116-2H	6P2H2 XXXX	2.85V

Characteristics Curve

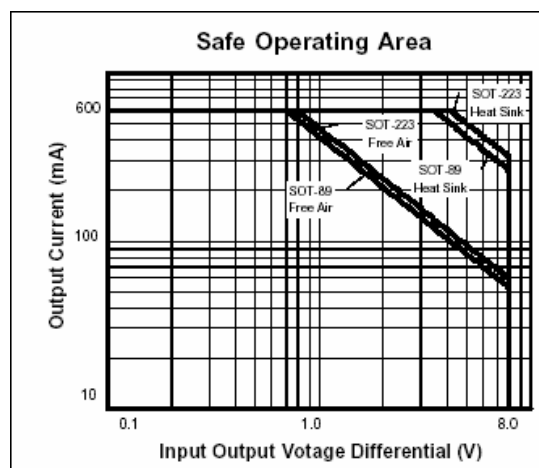
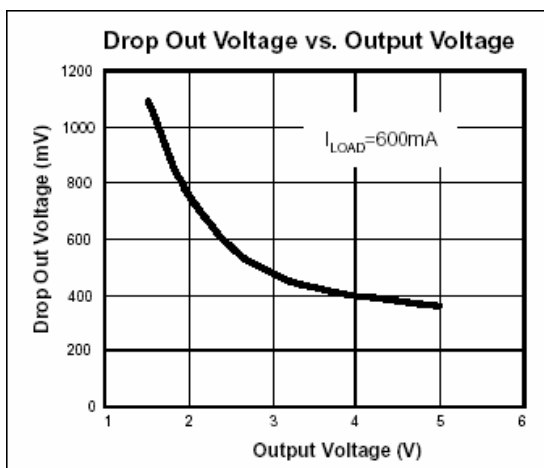
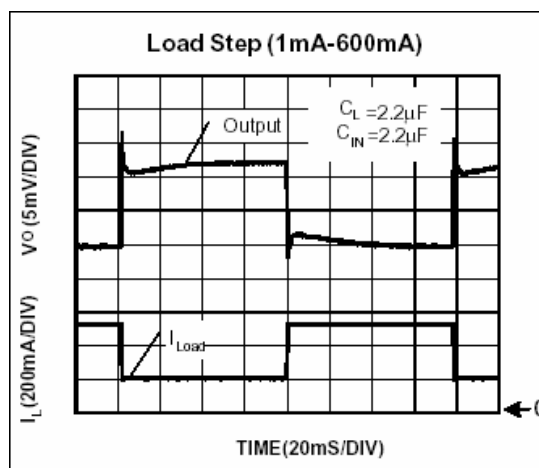
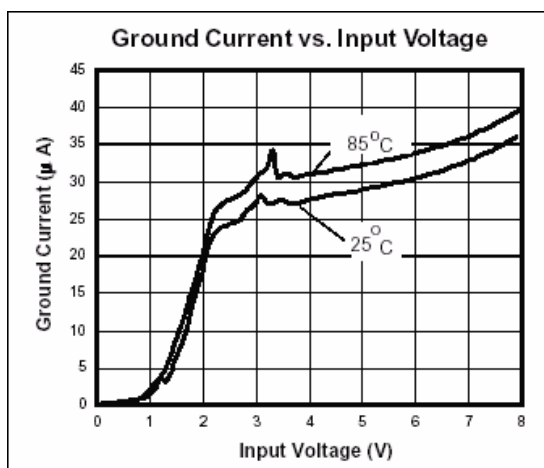

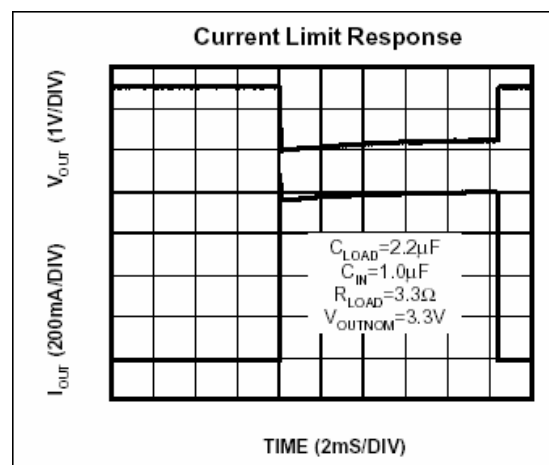
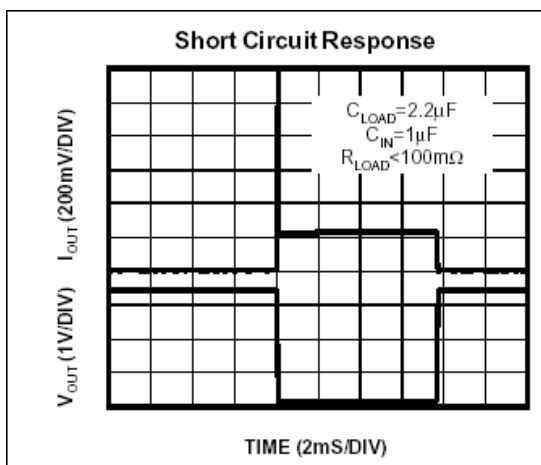
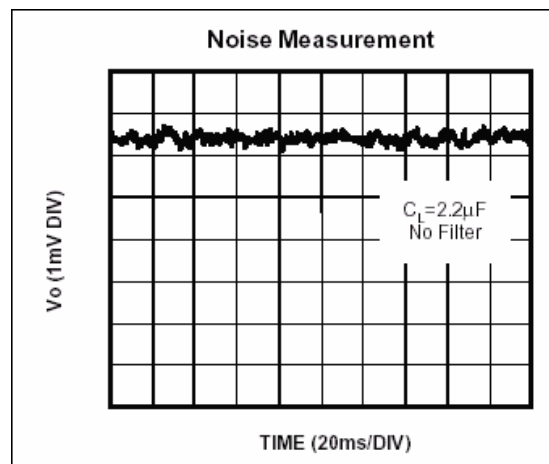
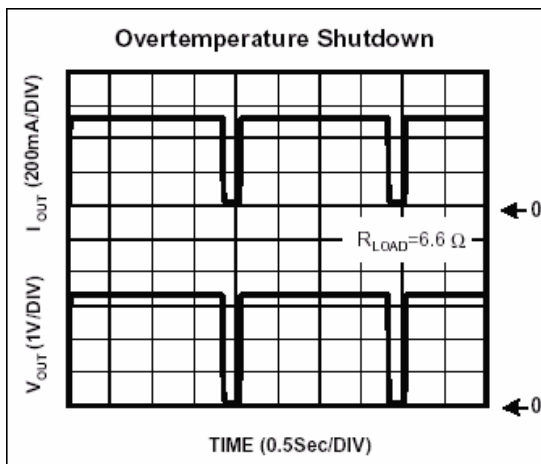
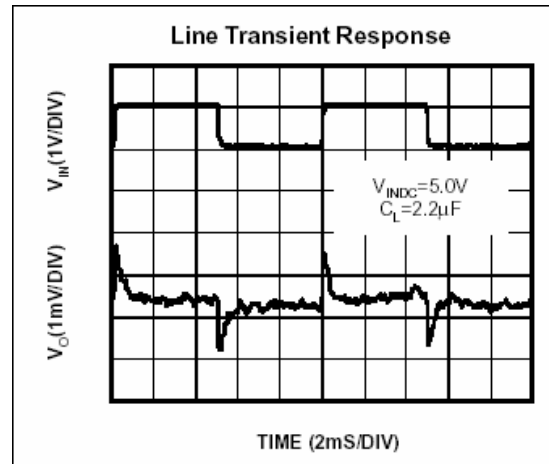
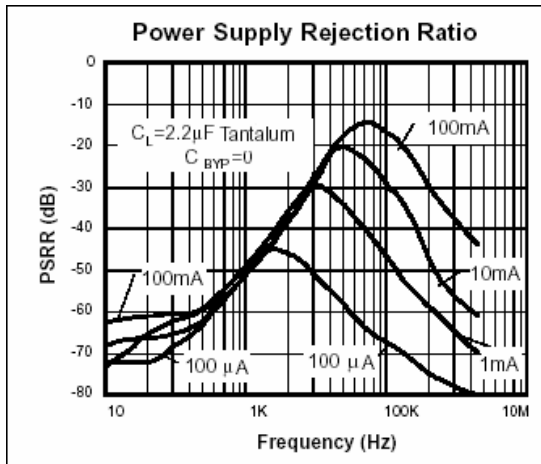
Important Notice:

- All rights are reserved. Reproduction in whole or in part is prohibited without the prior written approval of GTM.
- GTM reserves the right to make changes to its products without notice.
- GTM semiconductor products are not warranted to be suitable for use in life-support Applications, or systems.
- GTM assumes no liability for any consequence of customer product design, infringement of patents, or application assistance.

Head Office And Factory:

- Taiwan: No. 17-1 Tatung Rd. Fu Kou Hsin-Chu Industrial Park, Hsin-Chu, Taiwan, R. O. C.
- TEL : 886-3-597-7061 FAX : 886-3-597-9220, 597-0785
- China: (201203) No.255, Jang-Jiang Tsai-Lueng RD. , Pu-Dung-Hsin District, Shang-Hai City, China
- TEL : 86-21-5895-7671 ~ 4 FAX : 86-21-38950165