

GM6390

TONE/PULSE SWITCHABLE DIALER WITH REDIAL

Description

The GM6390 is a monolithic, integrated circuit manufactured using GS silicon Gate CMOS process. The device is TONE/PULSE switchable dialer with the last number redial memory and designed for low cost, high stability TONE/PULSE switchable telephone application.

The pause key and the pulse to tone key are provided for PBX and Long Distance company operation. The wide operating voltage range and low memory retention current facilitate this chip excellent for battery-free direct telephon-line operation.

Features

- DTMF/PULSE Switchable Dialer
- One 31-Digits for Last Number Redial Memory
- Auto Pause Access for PBX Operation; 3.1sec. per pause
- Pulse to Tone Key(P→T) for Toll Service Operation
- Key-Tone Output for Valid Keypad Entry Recognition.
- Electronic Keypad Input is Available; Low Action
- Uses Form A Keyboard or The Standard 2 of 8 Matrix Keyboard
- Uses Inexpensive 3.579545MHz Television Color-Burst Crystal.
- Pin Selectable for Break/Make Ratio
- Low Memory Retention Current; $\leq 0.2 \mu A$ at $V+=1.0V$, $\overline{HKS}=1$
- Low Operating Voltage; 2.0V for Both Tone and Pulse Mode
- Switching from Pulse Mode to Tone Mode in LDC Operation
- 22-Pin Dual-In-Line Package

Pin Connection

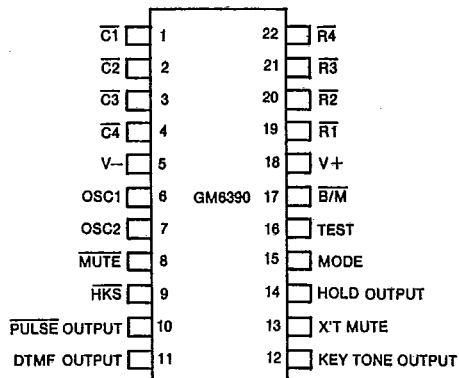

Keyboard Function

	C1	C2	C3	C4
R1	1	2	3	P→T
R2	4	5	6	H
R3	7	8	9	P
R4	*	0	#	R

P→T : Pulse to Tone Switch
 H : Hold
 P : Pause
 R : Redial

GM6390

T-75-07-07

Absolute Maximum Ratings

DC Supply Voltage V+	6.0V
Any Input Relative to V+	+0.3V
Any Input Relative to V-	-0.5V
Power Dissipation P _D	500mW(Ta=-25°C to +60°C)
Operating Temperature Topr	-25°C to +85°C
Storage Temperature Tstg	-65°C to +150°C

Functional Block Diagram

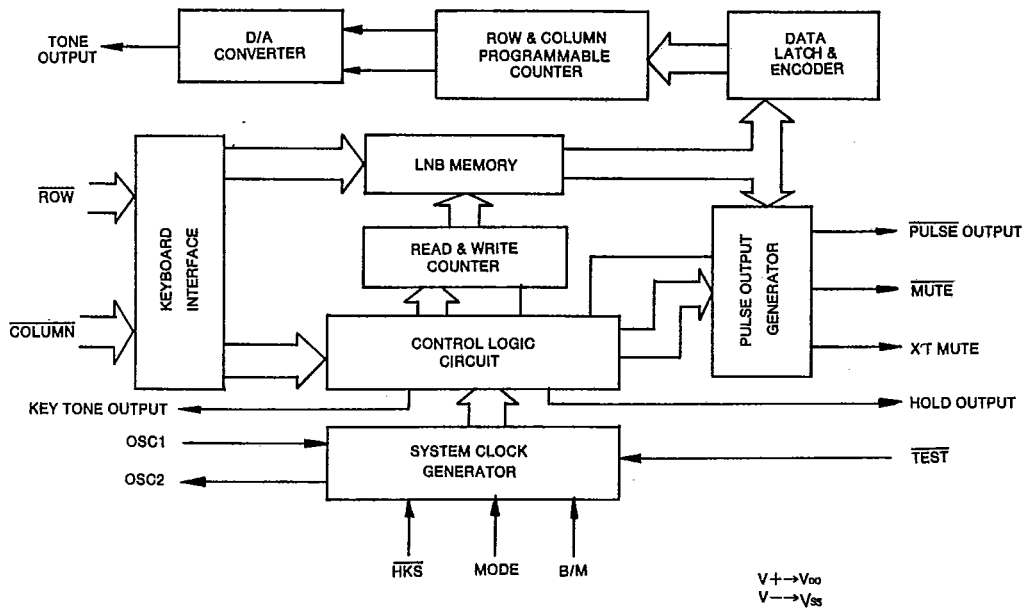

Electrical Characteristics

(Unless otherwise specified, $V_+ = 2.5V$, $T_a = 25^\circ C$)

T-75-07-07

DC Characteristics

SYMBOL	PARAMETER	TEST CIRCUIT	MIN.	TYP.	MAX.	UNIT	TEST CONDITIONS
V+	DC Operating Voltage		2.0	—	5.5	V	Tone
			2.0	—	5.5	V	Pulse
			1.0	—	5.5	V	Memory
I _r	Operating Current(Tone)	1	—	0.6	2	mA	Unloaded and Keypad Entry
I _p	Operating Current(Pulse)		—	0.2	0.5	mA	
I _s	Standby Current	1	—	0.1	5	μA	$\overline{HKS}=0$, Unloaded and No Keypad Entry
I _{MR}	Memory Retention Current	2	—	0.1	0.2	μA	$\overline{HKS}=1$, $V_+ = 1V$
V _{ro}	Tone Output Voltage	3	120	150	180	mV _{rms}	Row Group, $R_L = 10K \Omega$
THD	*DTMF Distortion	4	—	-30	-23	dB	$V_+ = 2.0 \sim 5.5V$, $R_L = 10K \Omega$
PE	Pre Emphasis	4	1	2	3	dB	$V_+ = 2.0 \sim 5.5V$, $R_L = 10K \Omega$
V _{roC}	Tone Output DC Level	4	0.5V+	—	0.6V+	V	$V_+ = 2.0 \sim 5.5V$ Keypad Entry
R _L	Tone Output Load Impedance	—	10	—	—	KΩ	THD ≤ -23dB
I _{ros}	Tone Output Sink Current	5	0.2	—	—	mA	$V_{ro} = 0.5V$, No Keypad Entry
I _{POL}	Pulse Output Leakage Current	5	—	—	0.1	μA	$V_{po} = 5V$
			—	—	1.0	μA	$V_{po} = 12V$
I _{POS}	Pulse Output Sink Current	6	1.0	3.0	—	mA	$V_{po} = 0.5V$
I _{MOD}	Mute Output Drive Current	5	-0.5	—	—	mA	$V_{MO} = 2.0V$
I _{MOS}	Mute Output Sink Current	5	2.0	—	—	mA	$V_{MO} = 0.5V$
I _{KOD}	Key Tone Output Dirve Current	5	-0.5	—	—	mA	$V_{KO} = 2.0V$
I _{KOS}	Key Tone Output Sink Current	5	0.5	—	—	mA	$V_{KO} = 0.5V$

GM6390

T-75-07-07

(Continued)

SYMBOL	PARAMETER	TEST CIRCUIT	MIN.	TYP.	MAX.	UNIT	TEST CONDITIONS
I _{XMD}	X'T Mute Drive Current	5	-0.5	—	—	mA	V _{XO} =2.0V
I _{XMS}	X'T Mute Sink Current	5	0.5	—	—	mA	V _{XO} =0.5V
I _{HOD}	HOLD OUTPUT Drive Current	5	-0.5	—	—	mA	V _{HO} =2.0V
I _{HOS}	HOLD OUTPUT Sink Current	5	0.5	—	—	mA	V _{HO} =0.5V
I _{KID}	Keypad Input Drive Current	8	4	10	30	μA	V _{KI} =0V
I _{KIS}	Keypad Input Sink Current	5,7	200	400	—	μA	V _{KI} =2.5V
I _{IN}	Control Pin Input Leakage Current	—	—	±10 ⁻⁸	±0.1	μA	$\overline{\text{HKS}}$, MODE

* Dual Tone Multi-Frequency distortion is measured in term of total out-of-band power related to sum of row and column fundamental power.

GM6390

T-75-07-07

AC Characteristics

SYMBOL	PARAMETER	MIN.	TYP.	MAX.	UNIT	TEST CONDITIONS
t _{KD}	Keypad Debounce Time	—	10	—	mS	$\overline{\text{TEST}}=1$
t _{PMO}	Pulse Mute Delay Time	—	40	—	mS	$\overline{\text{TEST}}=1$, B/M=60:40
		—	33.3	—	mS	$\overline{\text{TEST}}=1$, B/M=60:33
t _{PDP}	Pre-Dight Pause Time	—	40	—	mS	$\overline{\text{TEST}}=1$, B/M=60:40
		—	33.3	—	mS	$\overline{\text{TEST}}=1$, B/M=60:33
t _{TD}	Tone Duration Time	—	100	—	mS	Redial
t _{ITP}	Inter Tone Pause Time	—	106	—	mS	Redial
P _R	Pulse Rate	—	10	—	PPS	$\overline{\text{TEST}}=1$
		—	600	—	PPS	$\overline{\text{TEST}}=0$
R _{B/M}	Break/Make Ratio	—	60:40	—		B/M=1
		—	60:33	—		B/M=0
f _{R1}	Row1 Frequency	—	699	—	Hz	**ROW1
f _{R2}	Row2 Frequency	—	766	—	Hz	**ROW2
f _{R3}	Row3 Frequency	—	848	—	Hz	**ROW3
f _{R4}	Row4 Frequency	—	948	—	Hz	**ROW4
f _{C1}	Column 1 Frequency	—	1216	—	Hz	**COLUMN1
f _{C2}	Column 2 Frequency	—	1332	—	Hz	**COLUMN2
f _{C3}	Column 3 Frequency	—	1472	—	Hz	**COLUMN3
f _K	Key Tone Frequency	—	1.2	—	KHz	—

**Use 3.579545 MHz Crystal (R_s ≤ 100 Ω, L_m = 96mH,
C_m = 0.25pF, Ch = 5pF, C_L = 18pF and ΔF ≤ ±200ppm)

GM6390

T-75-07-07

Test Circuit (V+ → V_{DD}, V- → V_{SS})

1.

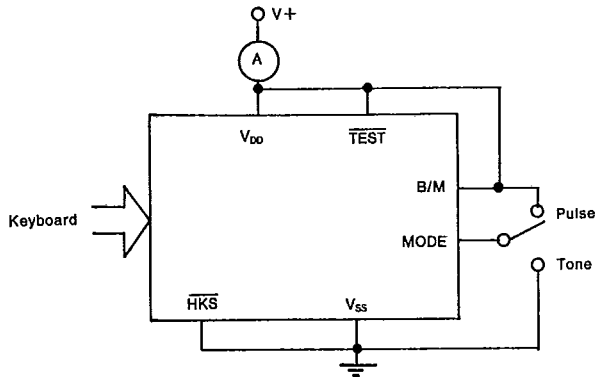

2.

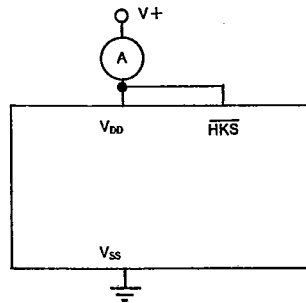

3.

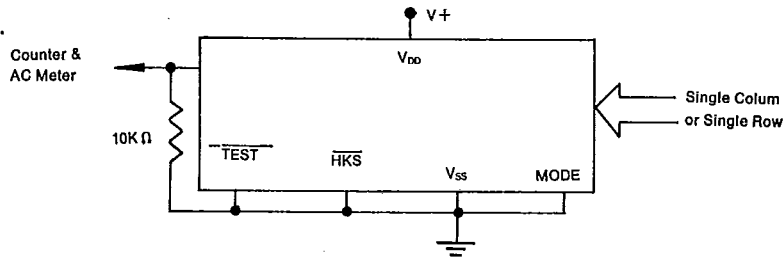

4.

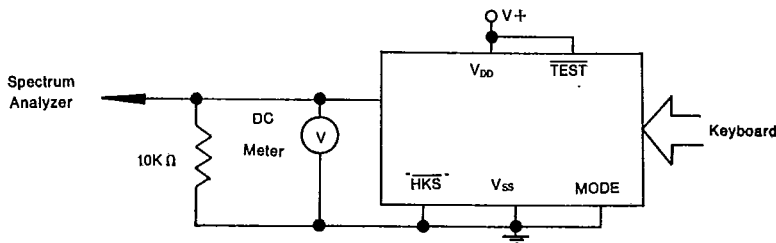

$$THD = 20 \log \frac{\sqrt{(V_1)^2 + (V_2)^2 + \dots + (V_n)^2}}{\sqrt{(V_L)^2 + (V_H)^2}}$$

* V₁, ..., V_n are harmonic frequency components in the 500Hz to 3400Hz band.

* V_L, V_H are the individual frequency components of the DTMF signal.

GM6390

T-75-07-07

5.

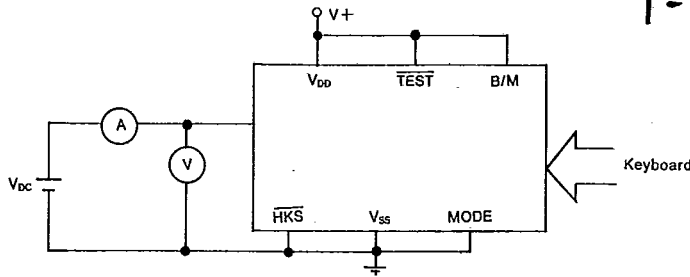

6.

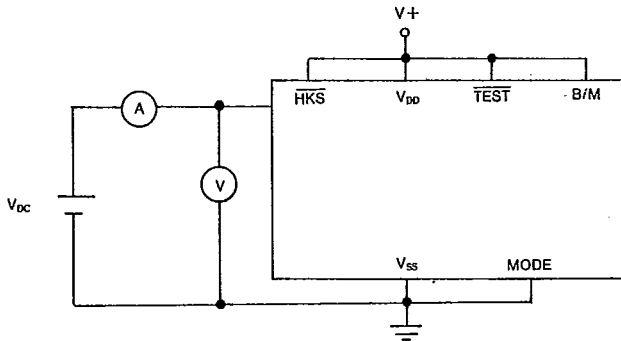

7.

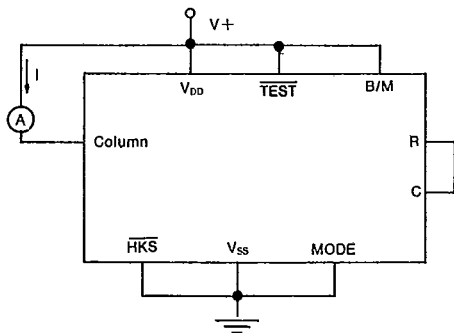

- * R: Anyone of R1~R4
- * C: Anyone of C1~C4
- * $I_{KD} = I / (1 - \text{Duty Cycle})$
- * Current(I) is the dc current measured from ampere meter.

8.

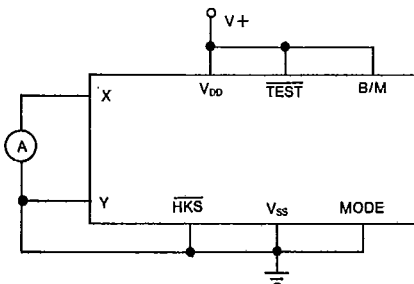

- * When column drive current is tested, the X is Column and Y is Row. When row drive current is tested, they are changed.
- * $I_{KD} = I / \text{Duty Cycle}$
- * Current(I) is the dc current measured from ampere meter.

GM6390

T-75-07-07

Functional Pin Description

* V+ (Pin 18)

Pin 18 is the positive supply for the circuit and must meet the maximum and minimum voltage requirements.

* V- (Pin 5)

Pin 5 is the negative supply input to the device. This is voltage reference for all specifications.

* C1, C2, C3, C4, R1, R2, R3, R4

The Keypad input interface with either the standard 2 of 8 keyboard or the inexpensive single contact (Form A) keyboard. Figure 1. shows how to connect to the two keyboard types and Figure 2 shows waveform electronic inputs.

In normal operation, a valid keypad entry is a single Row connected to a single Column. Activation of two or more buttons will result in no response except for single tone, TABLE 1 illustrates address keypads function in detail.

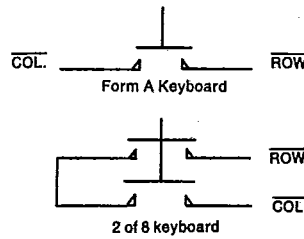
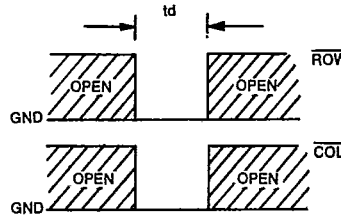

Figure 1. Keyboard Configuration



td is minimum tone duration plus keypad debounce time.

Figure 2. Electronic Input

TABLE 1. Address Keypads Truth Table

		Active Low Input		Output	
		ROW	COLUMN	Tone	Pulse
		Tone (MODE=0) Pulse (MODE=1)	Normal (TEST=1)	One	One
Two or More	One			V-	Open
One	Two or More				
Two or More	Two or More				
Under Test (TEST=0)	One		One	Dual Tone	600pps
	Two or More		One	Column Tone	Open
	One		Two or More	Row Tone	
	Two or More		Two or More	V-	

T-75-07-07 GM6390

*** OSC1, OSC2**

Input/Output, Pin 6,7, OSC1 and OSC2 and inputs to an on-chip inverter used as the timing reference for the circuit. It has sufficient loop gain to oscillate when used with a low cost 3.579545MHz television color-burst crystal. The oscillator is disabled when no keypad input been sensed.

An on-board counter is used to decrease the frequency of oscillator, and creates keypad debounce, mute delay, pre-digit pause, Break-Make ratio, tone duration, Row group and Column group frequency and key tone frequency etc. Any deviation from the nominal crystal frequency is directly reflected in the time parameters above.

*** MUTE**

The MUTE Output, pin 8, is a conventional CMOS inverter which is pulled to high normally during standby, but pulled

low in the transmitting period of the address code.

*** HKS**

The HKS, hookswitch, input is used to detect the state of hand set in ON-HOOK or OFF-HOOK. This is a high impedance input and must be switched high for ON-HOOK operation or low for OFF-HOOK operation.

*** PULSE Output**

The PULSE Output, pin 10, is consisted of an open drain N-channel device. In OFF-HOOK state, this NMOS transistor keeps in ON-state only in break duration, but OFF-state in make or normal duration, in order to send the pulses train of the address codes in pulse mode. Figure 3. shows this timing.

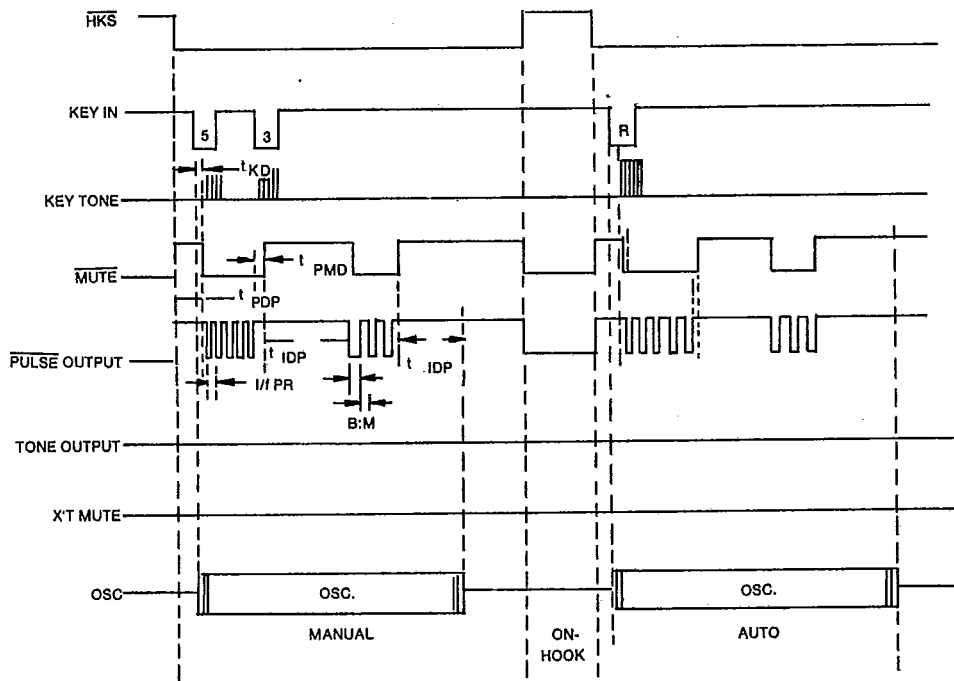

Figure 3. Pulse Mode Timing

T-75-07-07

*** DTMF Output**

The DTMF Output, pin 11, keeps low state regardless of keypad input in pulse mode but this pin outputs dual or single tone using the method illustrated in TABLE1 in DTMF mode. In manual dialing, the tone duration equals to the period of button pushed minus the keypad debounce time. In auto dialing, the tone duration and inter-tone-pause is internally set to be 100ms and 106ms respectively. Figure 4. shows tone mode timing.

*** KEY TONE Output**

The KEYTONE Output, Pin 12, is a conventional CMOS inverter that is used to drive a piezo buzzer. This pin output is a 1.2KHz square wave and provides audible feedback, confirming that the key has been properly entered and accepted. In spite of DTMF or PULSE mode, the keytone actuates after any keypad (including column4) entry is detect and ceases at the time of button released. There is not keytone output whenever

two or more keyboard button are pushed simultaneously.

*** X'T MUTE**

The X'T MUTE is a conventional CMOS inverter. In pulse mode, the X'T MUTE always keeps low level. In tone mode, it is also at low level with no keypad entry, but goes to high state when keyboard is pushed. Figure 3 and 4 show the waveform in detail. With the exception of controlling LED for indication, it can be used for muting operation in Tone mode also.

*** HOLD Output**

The Hold out is a conventional flip-flop. It is reset to low level by picking up the handset, and set to high level responding to push the "H" button, and go down if push the "H" button again. The "H" key is disabled and reset to low level when dialing. The Hold out is used to drive a melody IC for hold line application.

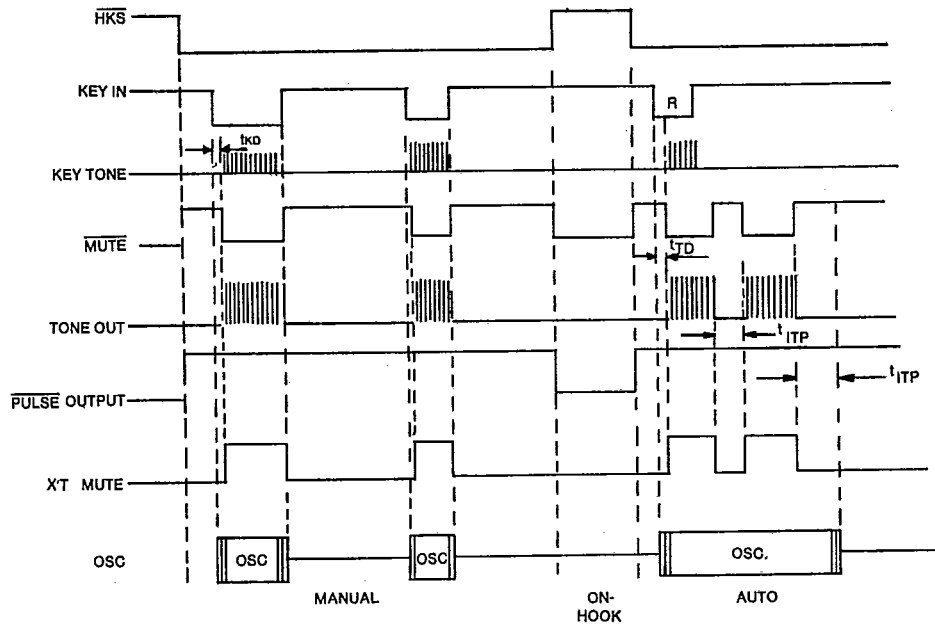

Figure 4. Tone Mode Timing

GM6390

T-75-07-07

*** MODE**

There are two methods of switching the IC to be pulse or tone dialer. One is MODE Selection pin, pull it to high, the dialer is in pulse mode. On the contrary, the dialer is in tone mode. The other is "P→T", pulse to tone keypad, when MODE is tied to high (in pulse mode), it is changed to tone mode after pushing "P→T" button. And reset to pulse mode by putting the handset back. In tone mode (MODE=0), the "P→T" button actuates nothing.

In auto redialing, the "P→T" button is not only changing mode but also providing 3.1 sec. pause if it was stored in memory previously.

*** TEST**

If TEST pin is tied to high, the IC is in normal operation. the pulse rate is 10pps and single tone is inhibited. If TEST pin is tied to GND, the IC is under test, single tone can be created with the operation shown in TABLE 1, and all of pulse time parameter are divided by rate of 60.

*** B/M**

In pulse mode, the Break/Make ratio is 60:40, if B/M=1; the ratio is 66 $\frac{2}{3}$:33 $\frac{1}{3}$, if B/M=0, the B/M pin influences nothing, in DTMF mode.

*** KEYBOARD OPERATIONS**

Note: All the keyboard operations should be under off-hook condition.

1. Normal Dialing

Select Pulse or Tone mode

Push $\overline{D1}, \overline{D2}, \dots, \overline{Dn}$; $D1 \sim Dn$: 0~9, *, #; n is unlimited.
Then the number D1, D2, ..., Dn will be dialed out in pulse or Tone mode as selected. (Excluding of *, # in Pulse mode)

2. Redialing

Select Pulse or Tone mode

Push $\overline{D1}, \overline{D2}, \dots, \overline{Dn}$; $n \leq 31$; if busy, after ON-HOOK, Come OFF-HOOK, push \overline{R} , the last number D1, D2, ..., Dn will be automatically dialed out in Pulse or Tone mode as selected again.

3. Mix-Dialing

$\overline{REDIALING}$ + $\overline{MANUAL DIALING}$ is allowable.

4. Pause and Pulse to Tone Keys Operation

In some case, such as PABX or LDC service, pause should

be inserted in dialing sequence and different dialing mode, Pulse or Tone mode, is needed. The chip provides user with pause function and Pulse/Tone switchable, which facilitate flexible application.

(a) Dialing with Pause

Select pulse or Tone mode

Push $\overline{D1}, \overline{P}, \overline{D2}, \dots, \overline{Dn}$; $D1 \sim Dn$: 0~9, *, #

Then the number will be dialed out as following sequence:
D1, D2, ..., Dn; without pause.

(b) Redialing with Pause

When the dialing, operation as above has done, but busy, then ON-HOOK. Come OFF-HOOK, push \overline{R} , then the signal will be dialed out automatically as following sequence:

D1, pause 3.1 sec., D2, ..., Dn.

(c) Dialing with Pulse to Tone Key

Select the Pulse or Tone mode

Push $\overline{D1}, \overline{D2}, \dots, \overline{Dn}, \overline{P \rightarrow T}, \overline{D1}, \overline{D2}, \dots, \overline{Dn}$

Then the number will be dialed out as following sequence:

1) If the mode switch is set in pulse mode, then the output signal will be:

D1, D2, ..., Dn, D'1, D'2, ..., D'n; without pause

(Pulse mode) (Tone mode)

2) If the mode switch is set in Tone mode, then the output signal will be:

D1, D2, ..., Dn, D'1, D'2, ..., D'n; without pause

(Tone mode) (Tone mode)

(d) Redialing with Pulse to Tone Key

When the dialing operation as above has done, but busy, then ON-HOOK. Come OFF-HOOK.

push \overline{R} , then the signal will be dialed out automatically as same sequence of dialing with Pulse to Tone key, but has a 3.1 sec. pause during changing mode.

5. Hold Line

OFF-HOOK when the telephone is ringing. If need hold line then:

Push \overline{H} , and melody will be sent. After a moment, if want to talk:

Push \overline{H} , again, then melody will be stopped.

Note:

- 1) The pause can be continuously stored for longer pause duration, but every pause will occupy one digit of memory size.
- 2) The Pulse to Tone Key also can be stored for longer pause but always change state from pulse to tone mode. It can be reset to pulse mode only in the operation of ON-HOOK.
- 3) Hold line is not ON-HOOK state.