

Description

The GM71V18160A is the new generation dynamic RAM organized 1,048,576 words x 16 bits. GM71V18160A has realized higher density, higher performance and various functions by utilizing advanced CMOS process technology. The GM71V18160A offers Fast Page Mode as a high speed access mode. Multiplexed address inputs permit the GM71V18160A to be packaged in standard 400 mil 42 pin plastic SOJ, standard 400 mil 44 (50) pin plastic TSOP II. The package size provides high system bit densities and is compatible with widely available automated testing and insertion equipment.

Features

- 1,048,576 Words x 16 Bit Organization
- Fast Page Mode Capability
- Single Power Supply (3.3V ± 0.3V)
- Fast Access Time & Cycle Time (Unit: ns)

	t _{rac}	t _{cac}	t _{rc}	t _{pc}
GM71V18160A-6	60	15	110	40
GM71V18160A-7	70	18	130	45
GM71V18160A-8	80	20	150	50

- Low Power
Active : 612/ 540/468mW (MAX)
Standby : 7.2mW (CMOS level : MAX)
0.54mW (L-series : MAX)
- $\overline{\text{RAS}}$ Only Refresh, $\overline{\text{CAS}}$ before $\overline{\text{RAS}}$ Refresh, Hidden Refresh Capability
- Self Refresh Operation (L-series)
- All inputs and outputs TTL Compatible
- 1024 Refresh Cycles/16ms
- 1024 Refresh Cycles/128ms (L-series)
- Battery Back Up Operation (L-series)
- 2 $\overline{\text{CAS}}$ byte Control

Pin Configuration

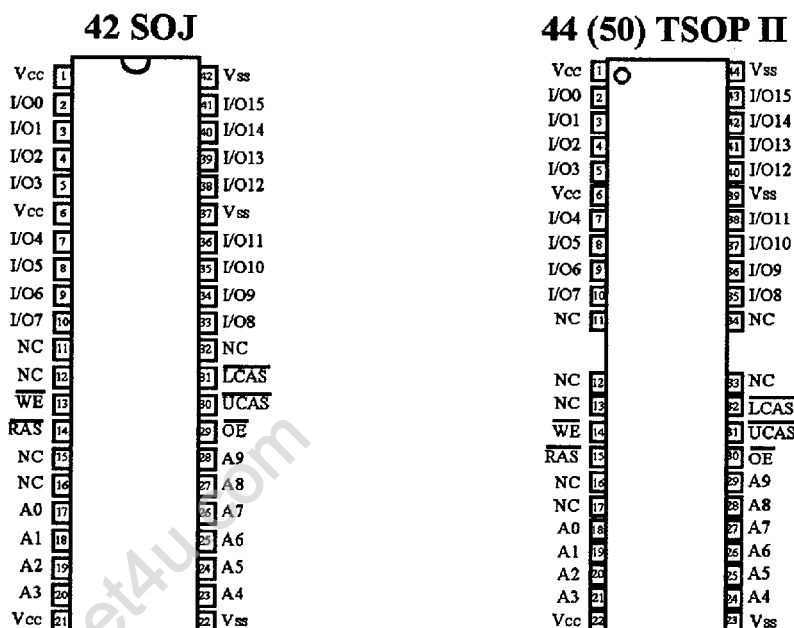

(Top View)

Pin Description

Pin	Function	Pin	Function
A0-A9	Address Inputs	\overline{WE}	Read/Write Enable
A0-A9	Refresh Address Inputs	\overline{OE}	Output Enable
I/O0-I/O15	Data-In/Out	V _{cc}	Power (+3.3V)
\overline{RAS}	Row Address Strobe	V _{ss}	Ground
$\overline{UCAS}, \overline{LCAS}$	Column Address Strobe	NC	No Connection

Ordering Information

Type No.	Access Time	Package
GM71V18160AJ-6 GM71V18160AJ-7 GM71V18160AJ-8	60 ns 70 ns 80 ns	400 Mil 42 Pin Plastic SOJ
GM71V18160AT-6 GM71V18160AT-7 GM71V18160AT-8	60 ns 70 ns 80 ns	400 Mil 44 (50) Pin Plastic TSOP II
GM71VS18160ALJ-6 GM71VS18160ALJ-7 GM71VS18160ALJ-8	60 ns 70 ns 80 ns	400 Mil 42 Pin Plastic SOJ
GM71VS18160ALT-6 GM71VS18160ALT-7 GM71VS18160ALT-8	60 ns 70 ns 80 ns	400 Mil 44 (50) Pin Plastic TSOP II

Absolute Maximum Ratings*

Symbol	Parameter	Rating	Unit
T _A	Ambient Temperature under Bias	0 ~ 70	°C
T _{STG}	Storage Temperature (Plastic)	-55 ~ 125	°C
V _{IN} /V _{OUT}	Voltage on any Pin Relative to V _{SS}	-0.5 ~ V _{CC} +0.5 (≤4.6V(max))	V
V _{CC}	Voltage on V _{CC} Relative to V _{SS}	-0.5 ~ +4.6	V
I _{OUT}	Short Circuit Output Current	50	mA
P _D	Power Dissipation	1.0	W

*Note: Operation at or above Absolute Maximum Ratings can adversely affect device reliability.

Recommended DC Operating Conditions (T_A = 0 ~ 70°C)

Symbol	Parameter	Min	Typ	Max	Unit
V _{CC}	Supply Voltage	3.0	3.3	3.6	V
V _{IH}	Input High Voltage	2.0	-	V _{CC} +0.3	V
V _{IL}	Input Low Voltage	-0.3	-	0.8	V

*Note: All voltage referred to V_{SS}.

Truth Table

$\overline{\text{RAS}}$	$\overline{\text{LCAS}}$	$\overline{\text{UCAS}}$	$\overline{\text{WE}}$	$\overline{\text{OE}}$	I/O0-I/O7	I/O8-I/O15	Operation	Notes
H	H	H	H	H	High-Z	High-Z	Standby	1,3
L	H	H	H	H	High-Z	High-Z	Refresh	1,3
L	L	H	H	L	D _{OUT}	High-Z	Lower Byte Read	1,3
L	H	L	H	L	High-Z	D _{OUT}	Upper Byte Read	1,3
L	L	L	H	L	D _{OUT}	D _{OUT}	Word Read	1,3
L	L	H	L	H	D _{IN}	Don't Care	Lower Byte Write	1,2,3
L	H	L	L	H	Don't Care	D _{IN}	Upper Byte Write	1,2,3
L	L	L	L	H	D _{IN}	D _{IN}	Word Write	1,2,3
L	L	L	H	H	High-Z	High-Z		1,3
H to L	L	H	-	-	High-Z	High-Z	CBR Refresh or Self Refresh	1,3
H to L	H	L	-	-	High-Z	High-Z		
H to L	L	L	-	-	High-Z	High-Z		

*Note : 1. H: High(inactive), L: Low(active)

2. twcs ≥ 0ns: Early write cycle, twcs ≤ 0ns: Delayed write cycle

3. Mode is determined by the OR function of the $\overline{\text{UCAS}}$ and $\overline{\text{LCAS}}$. (Mode is set by the earliest of $\overline{\text{UCAS}}$ and $\overline{\text{LCAS}}$ active edge and reset by the latest of $\overline{\text{UCAS}}$ and $\overline{\text{LCAS}}$ inactive edge.)

However write OPERATION and output High-Z control are done independently by each $\overline{\text{UCAS}}$, $\overline{\text{LCAS}}$.

ex) if $\overline{\text{RAS}}=\text{H to L}$, $\overline{\text{LCAS}}=\text{L}$, $\overline{\text{UCAS}}=\text{H}$, then $\overline{\text{CAS}}$ -before- $\overline{\text{RAS}}$ refresh cycle is selected.

DC Electrical Characteristics ($V_{CC} = 3.3V \pm 0.3V$, $T_A = 0 \sim 70^\circ C$)

Symbol	Parameter	Min	Max	Unit	Note	
V_{OH}	Output Level Output "H" Level Voltage ($I_{OUT} = -2mA$)	2.4	V_{CC}	V		
V_{OL}	Output Level Output "L" Level Voltage ($I_{OUT} = 2mA$)	0	0.4	V		
I_{CC1}	Operating Current Average Power Supply Operating Current (\overline{RAS} , \overline{UCAS} or \overline{LCAS} Cycling: $t_{RC} = t_{RC\ min}$)	60 ns	-	170	mA	1, 2
		70 ns	-	150		
		80 ns	-	130		
I_{CC2}	Standby Current (TTL) Power Supply Standby Current (\overline{RAS} , \overline{UCAS} , $\overline{LCAS} = V_{IH}$, $D_{OUT} = High-Z$)	-	2	mA		
I_{CC3}	\overline{RAS} Only Refresh Current Average Power Supply Current \overline{RAS} Only Refresh Mode ($t_{RC} = t_{RC\ min}$)	60 ns	-	170	mA	2
		70 ns	-	150		
		80 ns	-	130		
I_{CC4}	Fast Page Mode Current Average Power Supply Current Fast Page Mode ($t_{RC} = t_{RC\ min}$)	60 ns	-	170	mA	1, 3
		70 ns	-	150		
		80 ns	-	130		
I_{CC5}	Standby Current (CMOS) Power Supply Standby Current (\overline{RAS} , \overline{UCAS} or $\overline{LCAS} \geq V_{CC} - 0.2V$, $D_{OUT} = High-Z$)	-	1	mA		
		-	0.15	mA	4	
I_{CC6}	\overline{CAS} -before- \overline{RAS} Refresh Current ($t_{RC} = t_{RC\ min}$)	60 ns	-	170	mA	
		70 ns	-	150		
		80 ns	-	130		
I_{CC7}	Battery Back Up Operating Current (Standby with CBR Refresh) ($t_{RC} = 31.3\ \mu s$, $t_{RAS} \leq 0.3\ \mu s$, $D_{OUT} = High-Z$)	-	0.4	mA	4	
I_{CC8}	Standby Current $\overline{RAS} = V_{IH}$ \overline{UCAS} , $\overline{LCAS} = V_{IL}$ $D_{OUT} = Enable$	-	5	mA	1	
I_{CC9}	Self-Refresh Mode Current (\overline{RAS} , \overline{UCAS} or $\overline{LCAS} \leq 0.2V$, $D_{OUT} = High-Z$)	-	200	μA	4	
$I_{(I)}$	Input Leakage Current Any Input ($0V \leq V_{IN} \leq 4.6V$)	-10	10	μA		
$I_{(O)}$	Output Leakage Current (D_{OUT} is Disabled, $0V \leq V_{OUT} \leq 4.6V$)	-10	10	μA		

Note: 1. I_{CC} depends on output load condition when the device is selected. $I_{CC(max)}$ is specified at the output open condition.

2. Address can be changed once or less while $\overline{RAS} = V_{IL}$.

3. Address can be changed once or less while \overline{LCAS} and $\overline{UCAS} = V_{IH}$.

4. L-Series & Self-refresh series.

Capacitance ($V_{CC} = 3.3V \pm 0.3V$, $T_A = 25^\circ C$)

Symbol	Parameter	Min	Max	Unit	Note
C_{I1}	Input Capacitance (Address)	-	5	pF	1
C_{I2}	Input Capacitance (Clocks)	-	7	pF	1
$C_{I/O}$	Output Capacitance (Data-In/Out)	-	7	pF	1, 2

Note: 1. Capacitance measured with Boonton Meter or effective capacitance measuring method.

2. LCAS and UCAS = V_{IH} to disable D_{OUT} .

AC Characteristics ($V_{CC} = 3.0V \pm 0.3V$, $T_A = 0 \sim 70^\circ C$, Notes 1, 2, 3, 19)
Test Conditions

Input rise and fall times : 5 ns

Output load : 2TTL gate + CL (100 pF)

Input timing reference levels : 0.8V, 2.0V

(Including scope and jig)

Output timing reference levels : 0.8V, 2.0V

Read, Write, Read-Modify-Write and Refresh Cycles (Common Parameters)

Symbol	Parameter	GM71V(S)18160 A/AL-6		GM71V(S)18160 A/AL-7		GM71V(S)18160 A/AL-8		Unit	Note
		Min	Max	Min	Max	Min	Max		
t_{RC}	Random Read or Write Cycle Time	110	-	130	-	150	-	ns	
t_{RP}	\overline{RAS} Precharge Time	40	-	50	-	60	-	ns	
t_{CP}	\overline{CAS} Precharge Time	10	-	10	-	10	-	ns	24
t_{RAS}	\overline{RAS} Pulse Width	60	10,000	70	10,000	80	10,000	ns	
t_{CAS}	\overline{CAS} Pulse Width	15	10,000	18	10,000	20	10,000	ns	
t_{ASR}	Row Address Set up Time	0	-	0	-	0	-	ns	
t_{RAH}	Row Address Hold Time	10	-	10	-	10	-	ns	
t_{ASC}	Column Address Set-up Time	0	-	0	-	0	-	ns	21
t_{CAH}	Column Address Hold Time	10	-	15	-	15	-	ns	21
t_{RCD}	\overline{RAS} to \overline{CAS} Delay Time	20	45	20	52	20	60	ns	3
t_{RAD}	\overline{RAS} to Column Address Delay Time	15	30	15	35	15	40	ns	4
t_{RSH}	\overline{RAS} Hold Time	15	-	18	-	20	-	ns	
t_{CSH}	\overline{CAS} Hold Time	60	-	70	-	80	-	ns	
t_{CRP}	\overline{CAS} to \overline{RAS} Precharge Time	5	-	5	-	5	-	ns	
t_{ODD}	\overline{OE} to D_{IN} Delay Time	15	-	18	-	20	-	ns	5
t_{DZO}	\overline{OE} Delay Time from D_{IN}	0	-	0	-	0	-	ns	6
t_{DZC}	\overline{CAS} Delay Time from D_{IN}	0	-	0	-	0	-	ns	6
t_T	Transition Time (Rise and Fall)	3	50	3	50	3	50	ns	7
t_{REF}	Refresh Period(1024 cycles)	-	16	-	16	-	16	ms	
	Refresh Period (1024 cycles, L-Series)	-	128	-	128	-	128	ms	

Read Cycle

Symbol	Parameter	GM71V(S)18160 A/AL-6		GM71V(S)18160 A/AL-7		GM71V(S)18160 A/AL-8		Unit	Note
		Min	Max	Min	Max	Min	Max		
t _{RAC}	Access Time from \overline{RAS}	-	60	-	70	-	80	ns	8, 9
t _{CAC}	Access Time from \overline{CAS}	-	15	-	18	-	20	ns	9, 10, 17
t _{AA}	Access Time from Address	-	30	-	35	-	40	ns	9, 11, 17
t _{OAC}	Access Time from \overline{OE}	-	15	-	18	-	20	ns	9,25
t _{RCS}	Read Command Setup Time	0	-	0	-	0	-	ns	21
t _{RCH}	Read Command Hold Time to \overline{CAS}	0	-	0	-	0	-	ns	12,22
t _{RRH}	Read Command Hold Time to \overline{RAS}	0	-	0	-	0	-	ns	12
t _{RAL}	Column Address to \overline{RAS} Lead Time	30	-	35	-	40	-	ns	
t _{CAL}	Column Address to \overline{CAS} Lead Time	30	-	35	-	40	-	ns	
t _{CLZ}	\overline{CAS} to Output in Low-Z	0	-	0	-	0	-	ns	
t _{OH}	Output Data Hold Time	3	-	3	-	3	-	ns	
t _{OHO}	Output Data Hold Time from \overline{OE}	3	-	3	-	3	-	ns	
t _{OFF}	Output Buffer Turn-off time	-	15	-	15	-	15	ns	13
t _{OEZ}	Output Buffer Turn-off Time to \overline{OE}	-	15	-	15	-	15	ns	13
t _{CDD}	\overline{CAS} to D _{IN} Delay Time	15	-	18	-	20	-	ns	5

Write Cycle

Symbol	Parameter	GM71V(S)18160 A/AL-6		GM71V(S)18160 A/AL-7		GM71V(S)18160 A/AL-8		Unit	Note
		Min	Max	Min	Max	Min	Max		
t _{WCS}	Write Command Setup Time	0	-	0	-	0	-	ns	14,21
t _{WCH}	Write Command Hold Time	10	-	15	-	15	-	ns	21
t _{WP}	Write Command Pulse Width	10	-	10	-	10	-	ns	
t _{RWL}	Write Command to \overline{RAS} Lead Time	15	-	18	-	20	-	ns	
t _{CWL}	Write Command to \overline{CAS} Lead Time	15	-	18	-	20	-	ns	23
t _{DS}	Data-in Setup Time	0	-	0	-	0	-	ns	15,23
t _{DH}	Data-in Hold Time	10	-	15	-	15	-	ns	15,23

Read-Modify-Write Cycle

Symbol	Parameter	GM71V(S)18160 A/AL-6		GM71V(S)18160 A/AL-7		GM71V(S)18160 A/AL-8		Unit	Note
		Min	Max	Min	Max	Min	Max		
t _{RWC}	Read-Modify-Write Cycle Time	155	-	181	-	205	-	ns	
t _{RWD}	$\overline{\text{RAS}}$ to $\overline{\text{WE}}$ Delay Time	85	-	98	-	110	-	ns	14
t _{CWD}	$\overline{\text{CAS}}$ to $\overline{\text{WE}}$ Delay Time	40	-	46	-	50	-	ns	14
t _{AWD}	Column Address to $\overline{\text{WE}}$ Delay Time	55	-	63	-	70	-	ns	14
t _{OEH}	$\overline{\text{OE}}$ Hold Time from $\overline{\text{WE}}$	15	-	18	-	20	-	ns	

Refresh Cycle

Symbol	Parameter	GM71V(S)18160 A/AL-6		GM71V(S)18160 A/AL-7		GM71V(S)18160 A/AL-8		Unit	Note
		Min	Max	Min	Max	Min	Max		
t _{CSR}	$\overline{\text{CAS}}$ Setup Time ($\overline{\text{CAS}}$ -before- $\overline{\text{RAS}}$ Refresh Cycle)	5	-	5	-	5	-	ns	21
t _{CHR}	$\overline{\text{CAS}}$ Hold Time ($\overline{\text{CAS}}$ -before- $\overline{\text{RAS}}$ Refresh Cycle)	10	-	10	-	10	-	ns	22
t _{RPC}	$\overline{\text{RAS}}$ Precharge to $\overline{\text{CAS}}$ Hold Time	0	-	0	-	0	-	ns	21

Fast Page Mode Cycle

Symbol	Parameter	GM71V(S)18160 A/AL-6		GM71V(S)18160 A/AL-7		GM71V(S)18160 A/AL-8		Unit	Note
		Min	Max	Min	Max	Min	Max		
t _{PC}	Fast Page Mode Cycle Time	40	-	45	-	50	-	ns	
t _{RASC}	Fast Page Mode $\overline{\text{RAS}}$ Pulse Width	-	100,000	-	100,000	-	100,000	ns	16
t _{ACP}	Access Time from $\overline{\text{CAS}}$ Precharge	-	35	-	40	-	45	ns	9, 17
t _{RHCP}	$\overline{\text{RAS}}$ Hold Time from $\overline{\text{CAS}}$ Precharge	35	-	40	-	45		ns	

Fast Page Mode Read-Modify-Write Cycle

Symbol	Parameter	GM71V(S)18160 A/AL-6		GM71V(S)18160 A/AL-7		GM71V(S)18160 A/AL-8		Unit	Note
		Min	Max	Min	Max	Min	Max		
t _{PRWC}	Fast Page Mode Read-Modify-Write Cycle Time	85	-	96	-	105	-	ns	
t _{CPW}	$\overline{\text{WE}}$ Delay Time from $\overline{\text{CAS}}$ Precharge	60	-	68	-	75	-	ns	14,22

Self Refresh Mode

Symbol	Parameter	GM71VS18160 AL-6		GM71VS18160 AL-7		GM71VS18160 AL-8		Unit	Note
		Min	Max	Min	Max	Min	Max		
t _{RASS}	$\overline{\text{RAS}}$ Pulse Width (Self-Refresh)	100	-	100	-	100	-	us	26
t _{RPS}	$\overline{\text{RAS}}$ Precharge Time (Self-Refresh)	110	-	130	-	150	-	ns	
t _{CHS}	$\overline{\text{CAS}}$ Hold Time (Self-Refresh)	-50	-	-50	-	-50	-	ns	23

- Notes :**
- AC measurements assume $t_r = 5$ ns.
 - An initial pause of 200us is required after power followed by a minimum of eight initialization cycles (any combination of cycles containing RAS-only refresh or CAS-before-RAS refresh).
 - Operation with the t_{RCd}(max) limit insures that t_{RAc}(max) can be met, t_{RCd}(max) is specified as a reference point only; if t_{RCd} is greater than the specified t_{RCd}(max) limit, then access time is controlled exclusively by t_{CAc}.
 - Operation with the t_{RAd}(max) limit insures that t_{RAc}(max) can be met, t_{RAd}(max) is specified as a reference point only; if t_{RAd} is greater than the specified t_{RAd}(max) limit, then access time is controlled exclusively by t_{AA}.
 - Either t_{ODD} or t_{CDd} must be satisfied.
 - Either t_{DZO} or t_{DZC} must be satisfied.
 - V_{IH} (min) and V_{IL} (max) are reference levels for measuring timing of input signals. Also, transition times are measured between V_{IH} (min) and V_{IL} (max).
 - Assumes that t_{RCd} ≤ t_{RCd} (max) and t_{RAd} ≤ t_{RAd} (max). If t_{RCd} or t_{RAd} is greater than the maximum recommended value shown in this table, t_{RAc} exceeds the value shown.
 - Measured with a load circuit equivalent to 2TTL loads and 100pF. (V_{OH}=2.4V, V_{OL}=0.4V)
 - Assumes that t_{RCd} ≥ t_{RCd} (max) and t_{RAd} ≤ t_{RAd} (max).
 - Assumes that t_{RCd} ≤ t_{RCd} (max) and t_{RAd} ≥ t_{RAd} (max).
 - Either t_{RCH} or t_{RRH} must be satisfied for a read cycles.
 - t_{OFF} (max) and t_{OEZ} (max) define the time at which the outputs achieve the open circuit condition and are not referred to output voltage levels.
 - t_{WCS}, t_{TRWD}, t_{TCWD}, t_{TAWD} and t_{CPW} are not restrictive operating parameters. They are included in the data sheet as electrical characteristics only; if t_{WCS} ≥ t_{WCS} (min), the cycle is an early write cycle and the data out pin will remain open circuit(high impedance) throughout the entire cycle; if t_{TRWD} ≥ t_{TRWD}(min), t_{TCWD} ≥ t_{TCWD}(min), and t_{TAWD} ≥ t_{TAWD}(min), or t_{TCWD} ≥ t_{TCWD}(min) t_{TAWD} ≥ t_{TAWD} (min) and t_{CPW} ≥ t_{CPW} (min), the cycle is a read-modify-write and the data output will contain data read from the selected cell; if neither of the above sets of conditions is satisfied, the condition of the data out (at access time) is indeterminate.
 - These parameters are referred to $\overline{\text{UCAS}}$ and $\overline{\text{LCAS}}$ leading edge in early write cycles and to $\overline{\text{WE}}$ leading edge in delayed write or read-modify-write cycles.
 - t_{RASc} defines $\overline{\text{RAS}}$ pulse width in fast page mode cycles.
 - Access time is determined by the longer of t_{AA} or t_{CAc} or t_{ACP}.
 - In delayed write or read-modify-write cycles, $\overline{\text{OE}}$ must disable output buffer prior to applying data to the device. After $\overline{\text{RAS}}$ is reset, if t_{OEh} ≥ t_{CWL}, the I/O pin will remain open circuit (high impedance); if t_{OEh} ≤ t_{CWL}, invalid data will be out at each I/O.
 - When both $\overline{\text{LCAS}}$ and $\overline{\text{UCAS}}$ go low at the same time, all 16-bits data are written into the device. $\overline{\text{LCAS}}$ and $\overline{\text{UCAS}}$ cannot be staggered within the same write/read cycles.
 - All the V_{cc} and V_{ss} pins shall be supplied with the same voltages.

21. t_{ASC} , t_{CAH} , t_{RCS} , t_{WCS} , t_{WCH} , t_{CSR} and t_{RPC} are determined by the earlier falling edge of \overline{UCAS} or \overline{LCAS} .
22. t_{CRP} , t_{CHR} , t_{RCH} , t_{ACP} and t_{CPW} are determined by the later rising edge of \overline{UCAS} or \overline{LCAS} .
23. t_{CWL} , t_{DH} , t_{DS} and t_{CHS} should be satisfied by both \overline{UCAS} and \overline{LCAS} .
24. t_{CP} is determined by the time that both \overline{UCAS} and \overline{LCAS} are high.
25. When output buffers are enabled once, sustain the low impedance state until valid data is obtained. When output buffer is turned on and off within a very short time, generally it causes large V_{CC}/V_{SS} line noise, which causes to degrade $V_{IH\ min}/V_{IL\ max}$ level.
26. Please do not use t_{RASS} timing, $10\ \mu s \leq t_{RASS} \leq 100\ \mu s$. During this period, the device is in transition state from normal operation mode to self refresh mode. If $t_{RASS} \geq 100\ \mu s$, then \overline{RAS} precharge time should use t_{RPS} instead of t_{RP} .
27. If you use distributed CBR refresh mode with $15.6\ \mu s$ interval in normal read/write cycle, CBR refresh should be executed within $15.6\ \mu s$ immediately after exiting from and before entering into self refresh mode.
28. If you use \overline{RAS} only refresh or CBR burst refresh mode in normal read / write cycle, 1024 cycles of dustributed CBR refresh with $15.6\ \mu s$ interval should be executed within 16ms immediately after exiting from and before entering into the self refresh mode.
29. Repetitive self refresh mode without refreshing all memory is not allowed. Once you exit from self refresh mode, all memory cells need to be refreshed before re-entering the self refresh mode again.

Notes concerning $2C_{AS}$ control

Please do not separate the $\overline{UCAS}/\overline{LCAS}$ operation timing intentionally. However skew between $\overline{UCAS}/\overline{LCAS}$ are allowed under the following conditions.

- (1) Each of the $\overline{UCAS}/\overline{LCAS}$ should satisfy the timing specifications individually.
- (2) Different operation mode for upper / lower byte is not allowed; such as following.

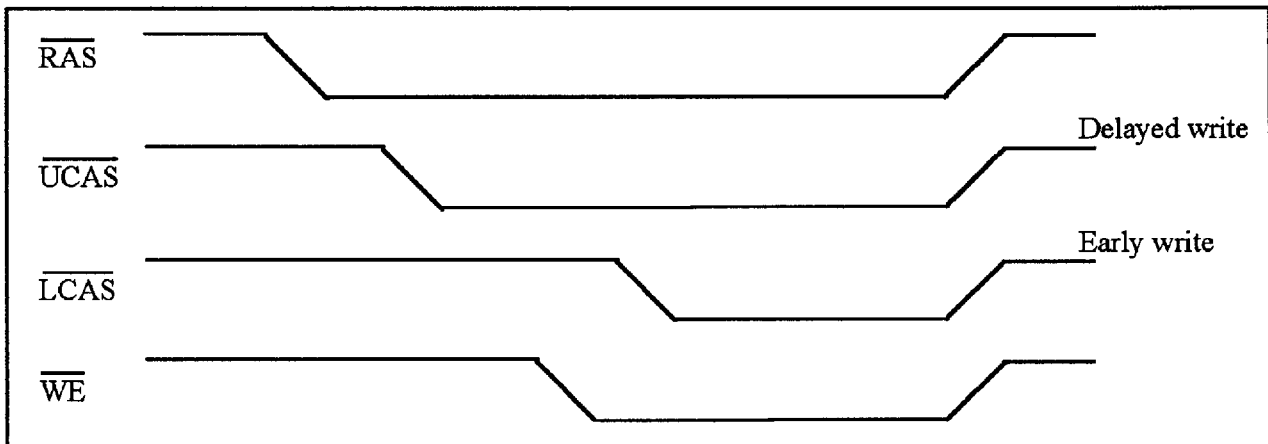

- (3) Closely separated upper / lower control is not allowed. However when the condition ($t_{CP} \leq t_{UL}$) is satisfied, fast page mode can be performed.

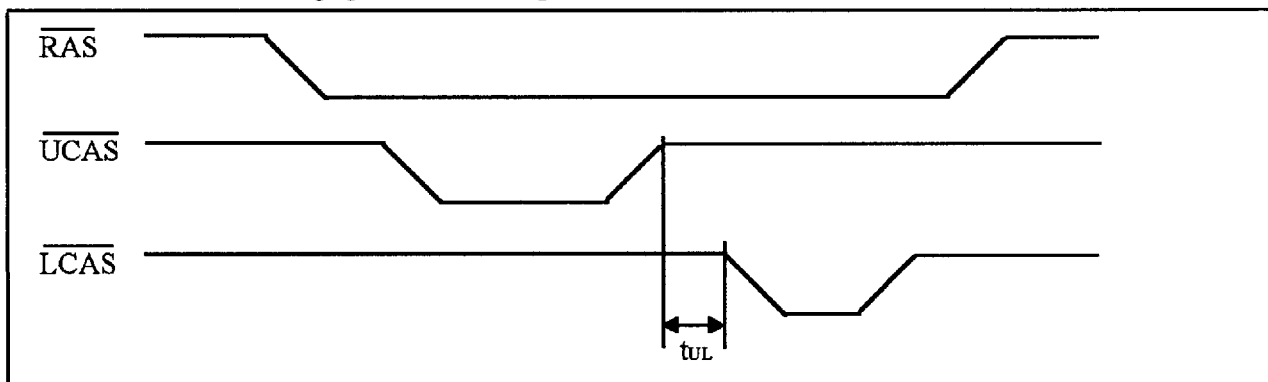

Timing Waveforms

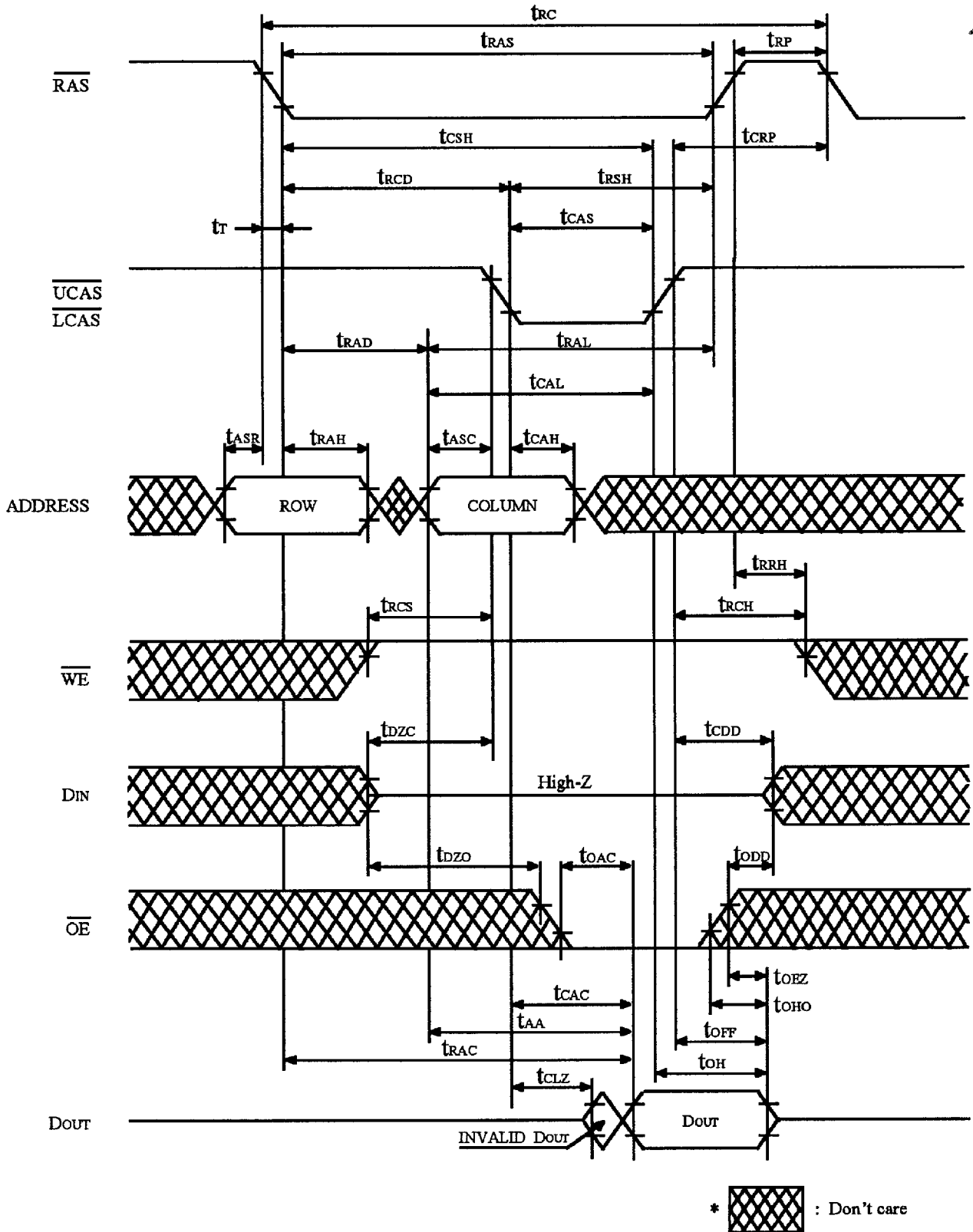
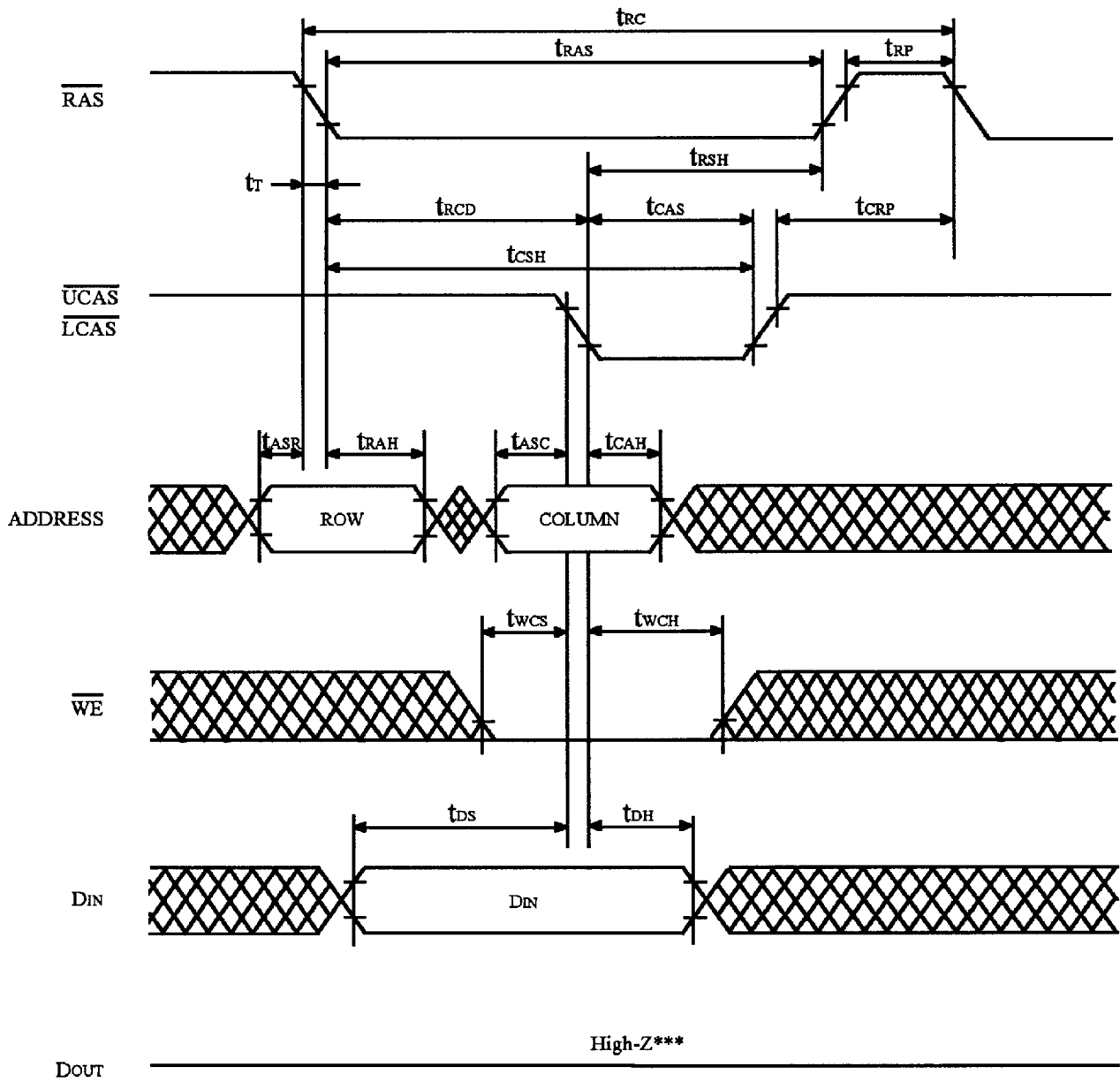

FIGURE 1. READ CYCLE



- *  : Don't care
- ** \overline{OE} : Don't care
- *** $t_{wcs} \geq t_{wcs}(\text{min})$

FIGURE 2. EARLY WRITE CYCLE

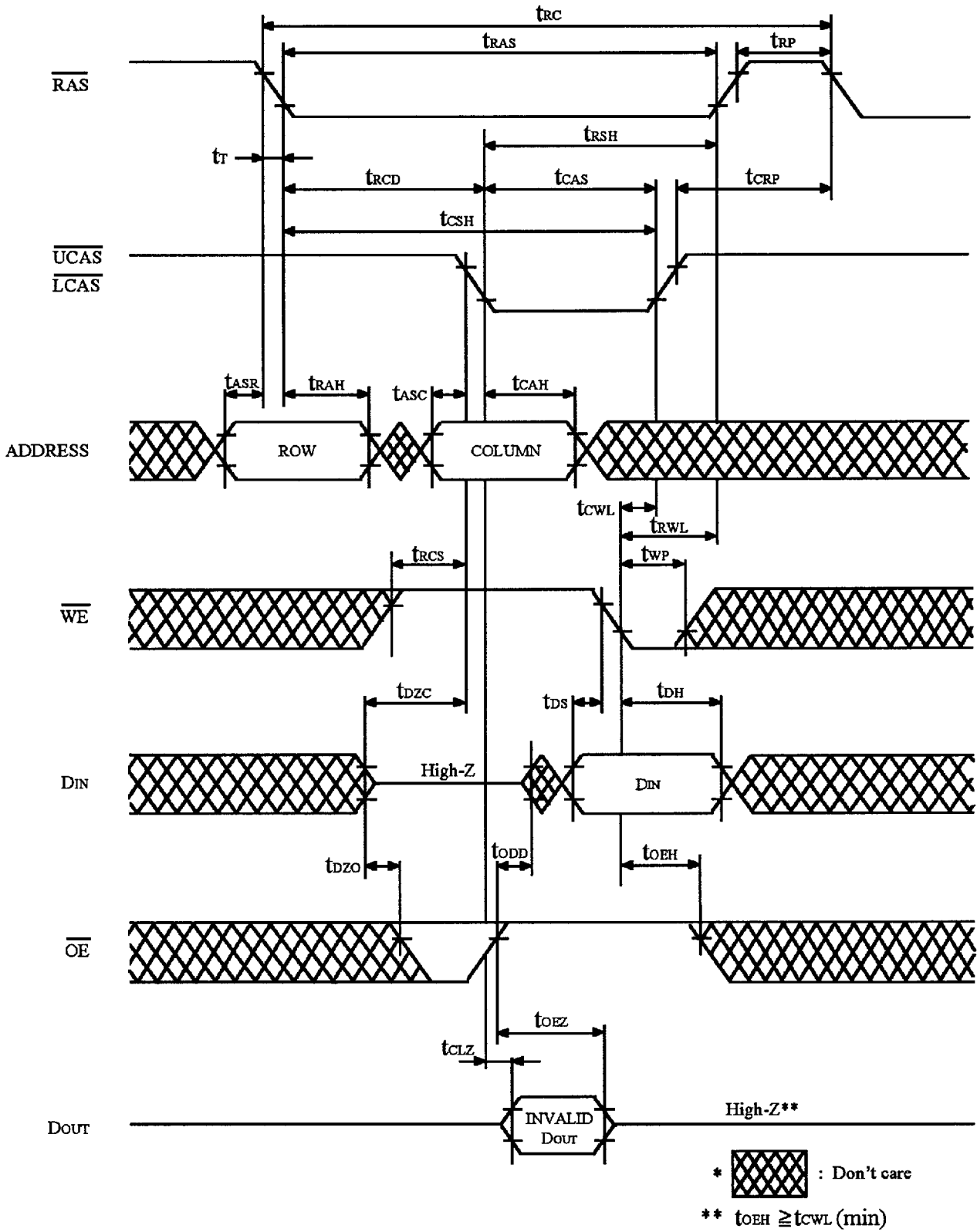

FIGURE 3. DELAYED WRITE CYCLE *19

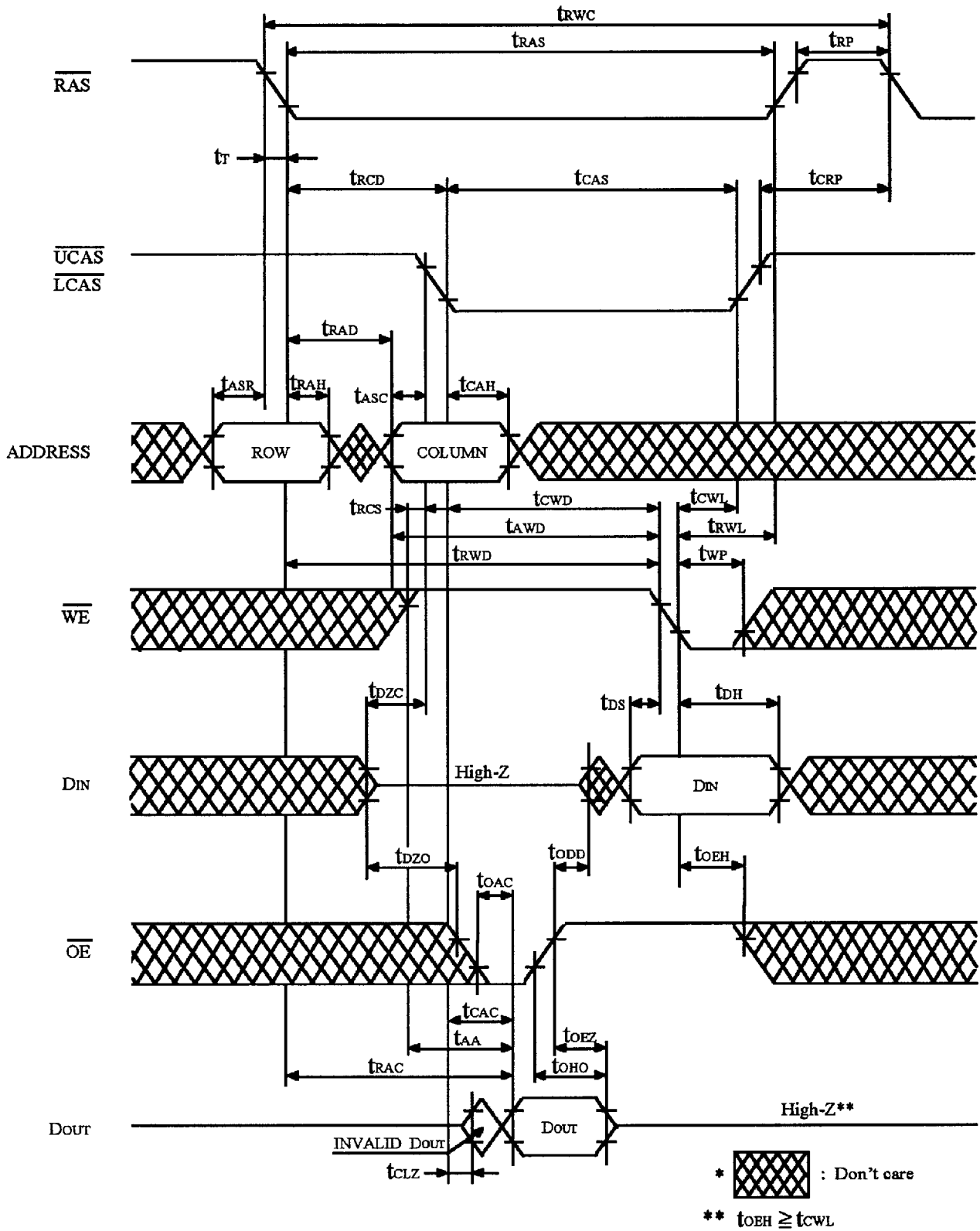
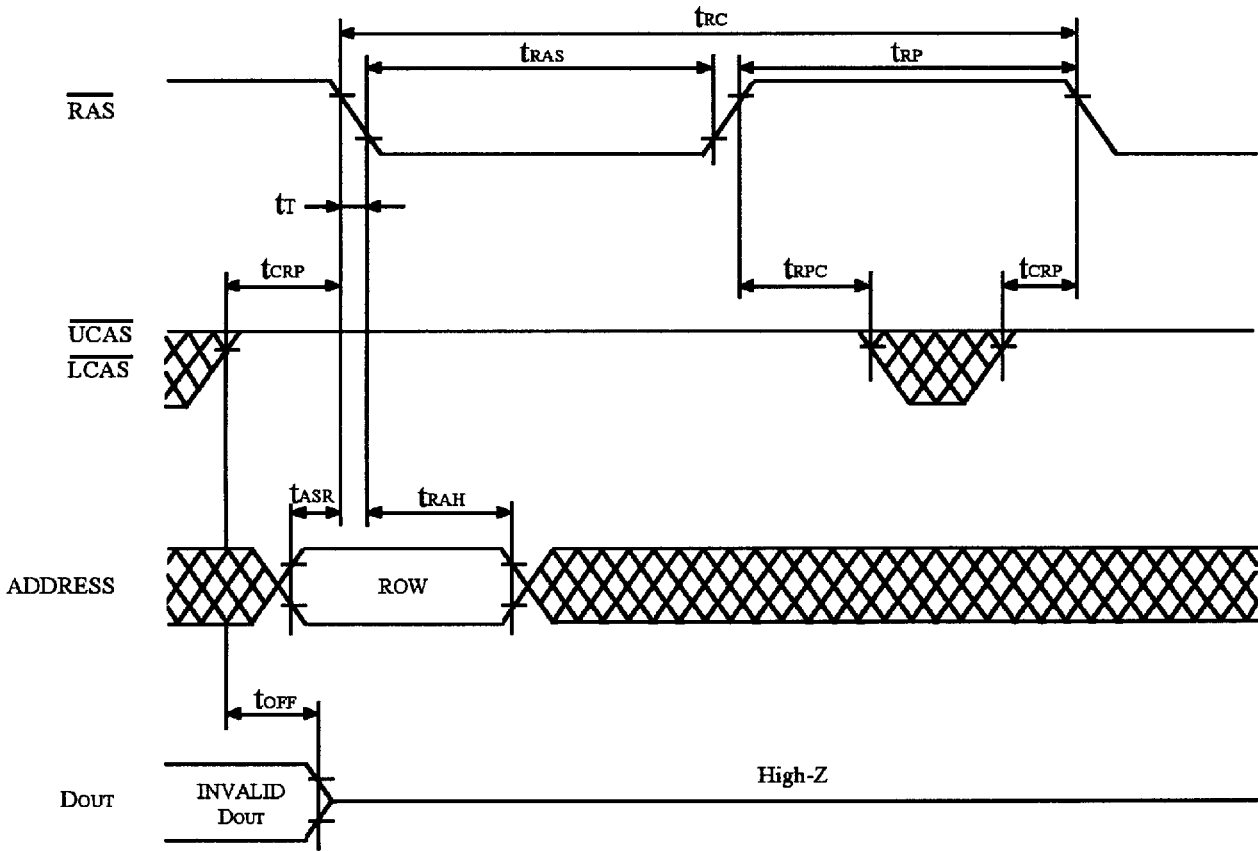

FIGURE 4. READ MODIFY WRITE CYCLE *19



- *  : Don't care
- ** \overline{OE} , \overline{WE} : Don't care
- *** Refresh Address:
A0-A9 (RA0-RA9)

FIGURE 5. \overline{RAS} ONLY REFRESH CYCLE

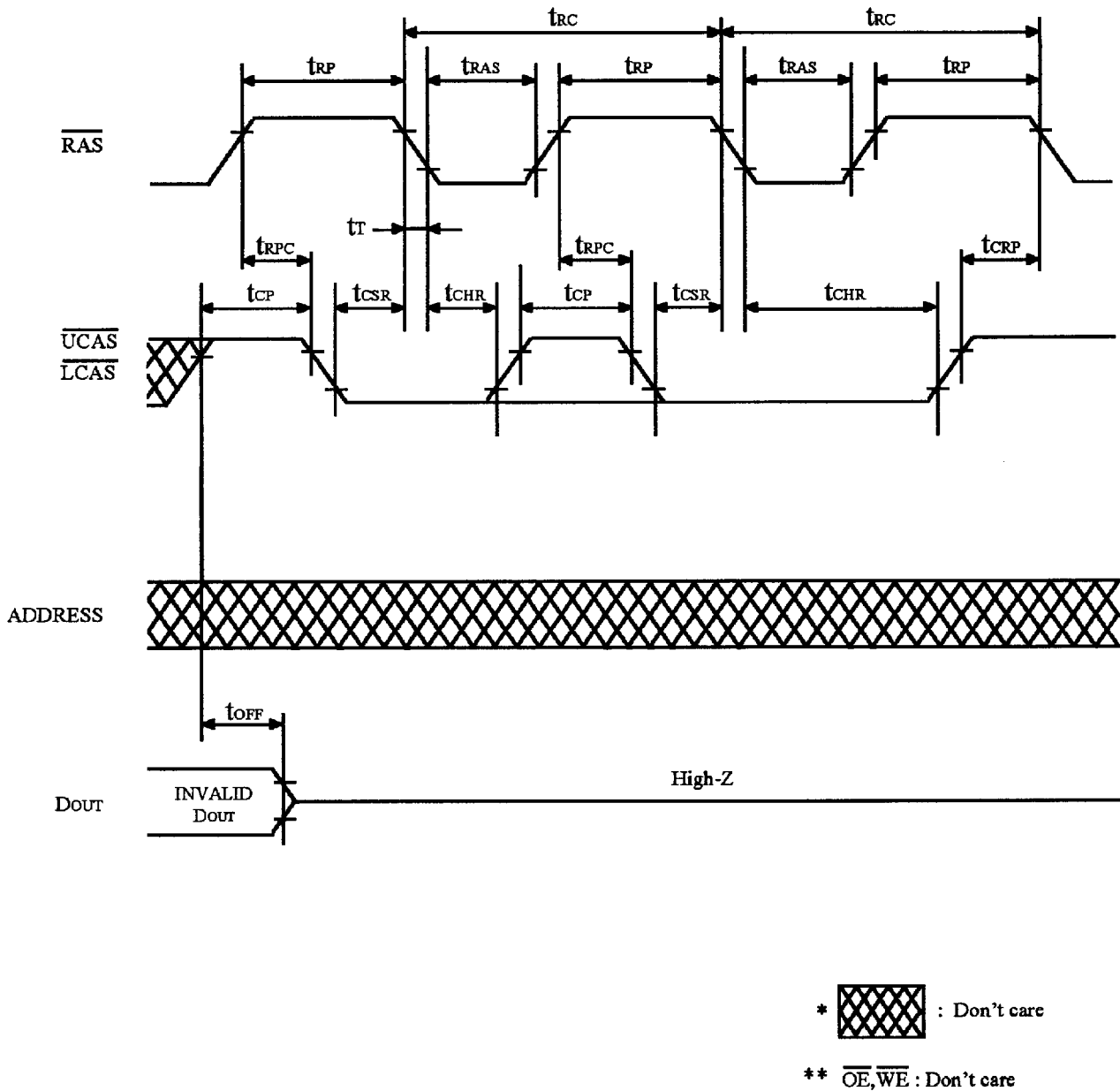

FIGURE 6. \overline{CAS} BEFORE \overline{RAS} REFRESH CYCLE

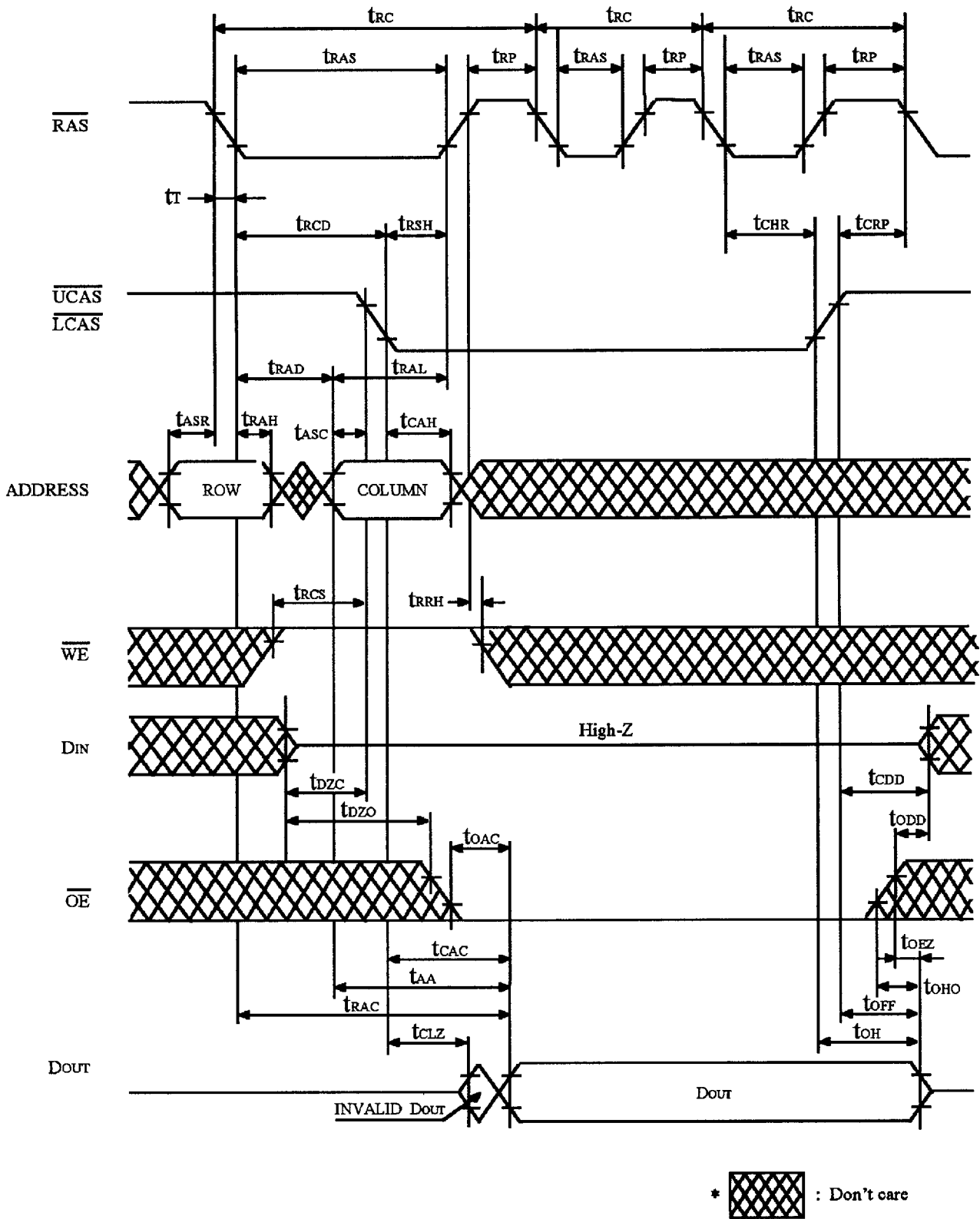

FIGURE 7. HIDDEN REFRESH CYCLE

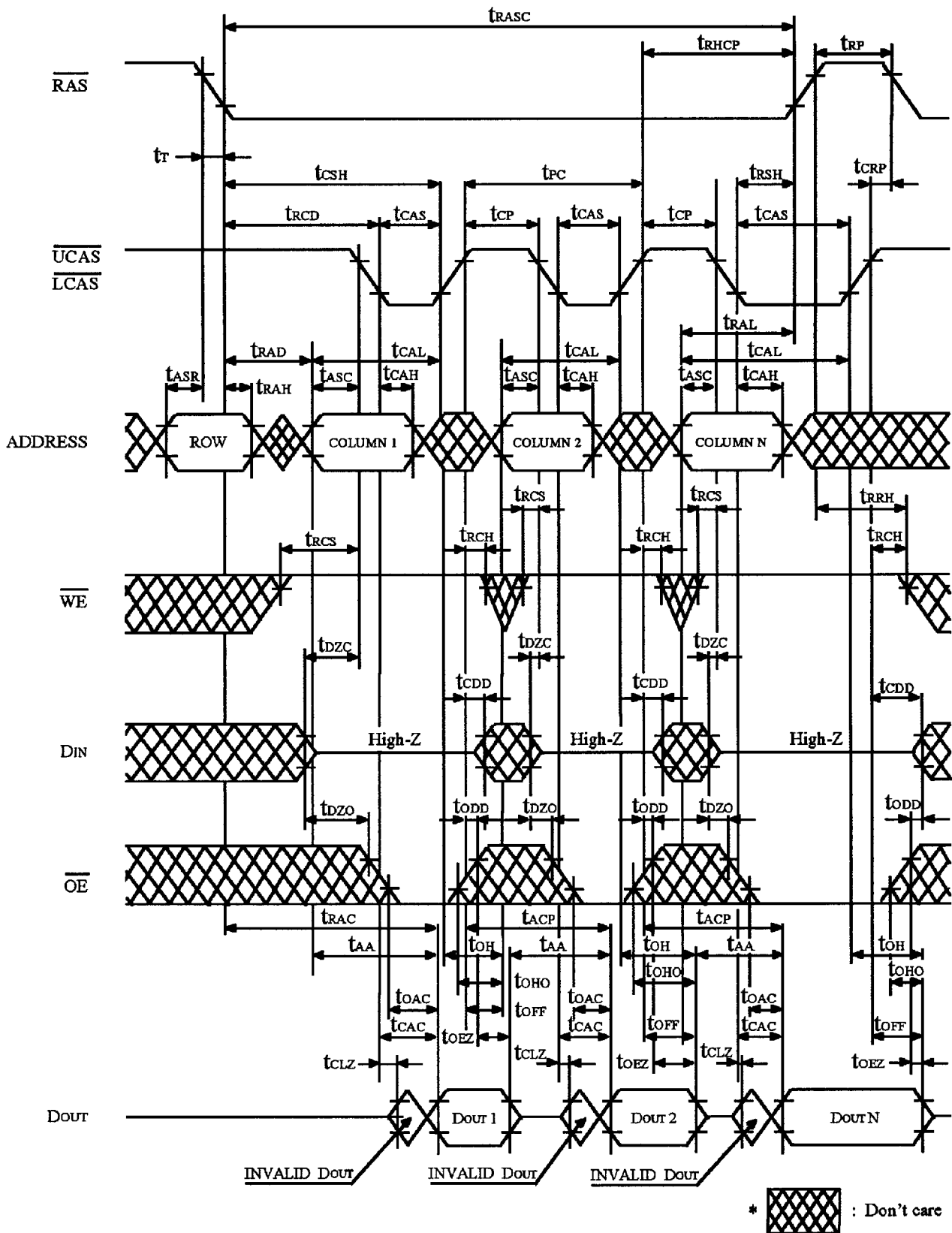

FIGURE 8. FAST PAGE MODE READ CYCLE

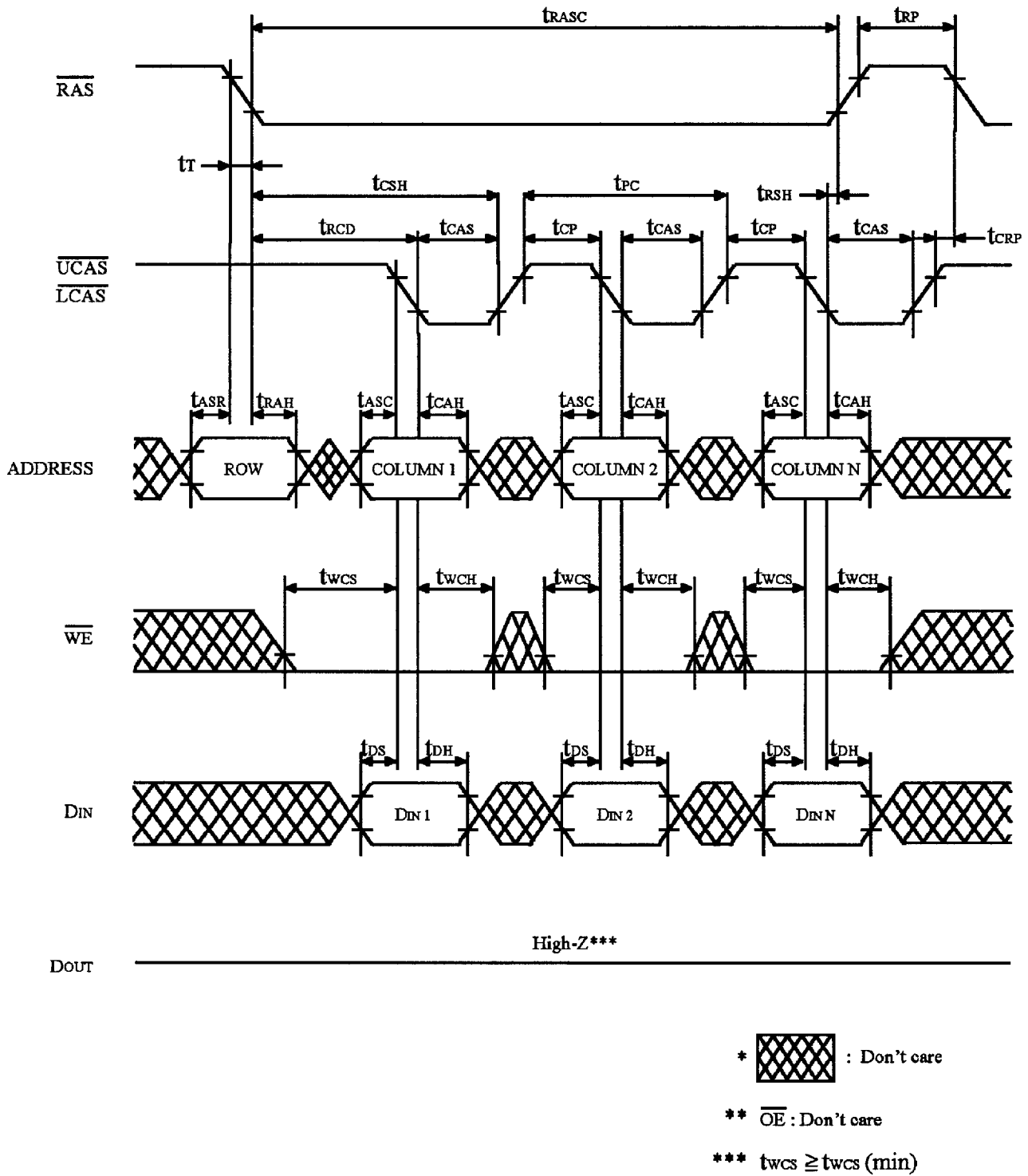

FIGURE 9. FAST PAGE MODE EARLY WRITE CYCLE

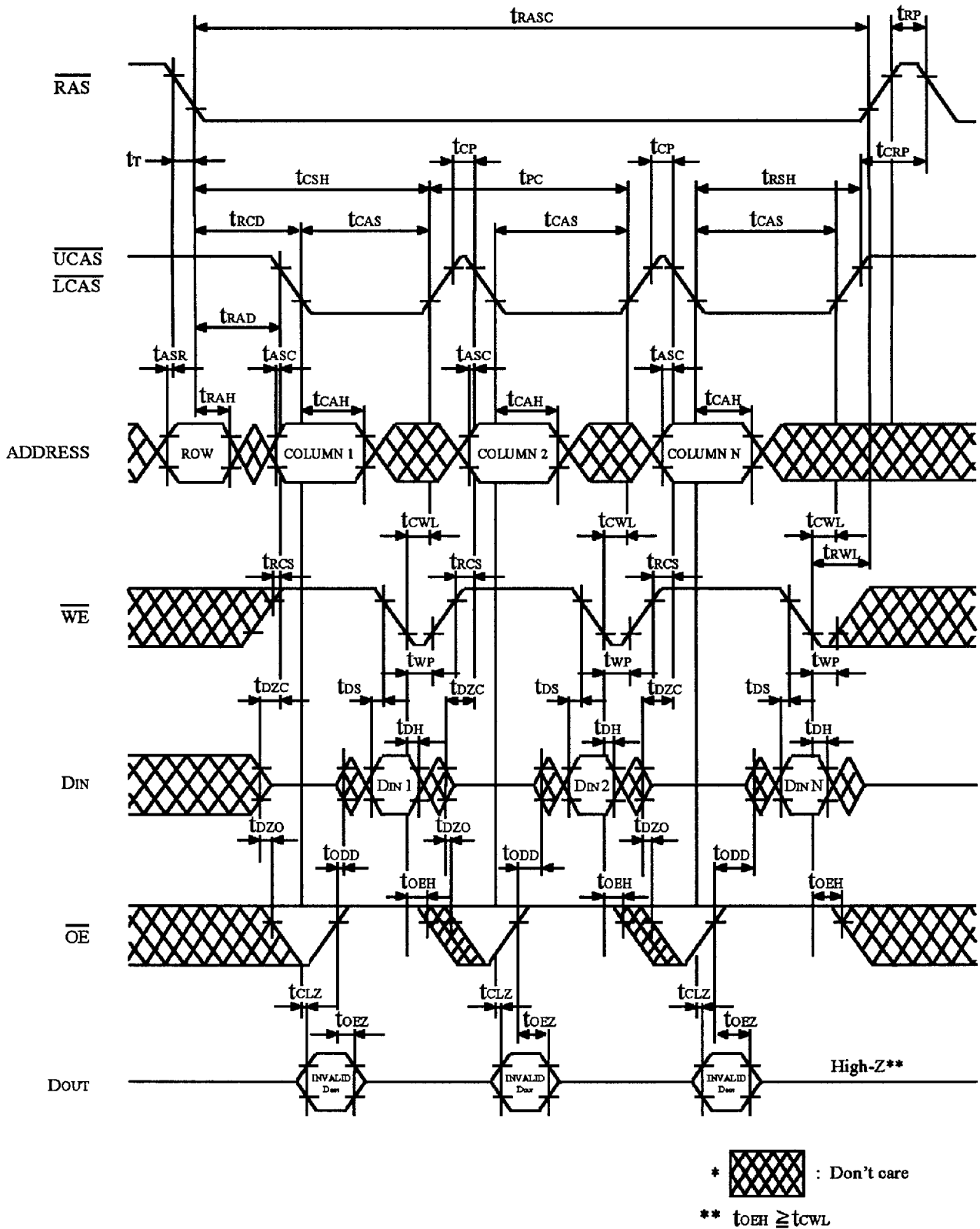

FIGURE 10. FAST PAGE MODE DELAYED WRITE CYCLE *19

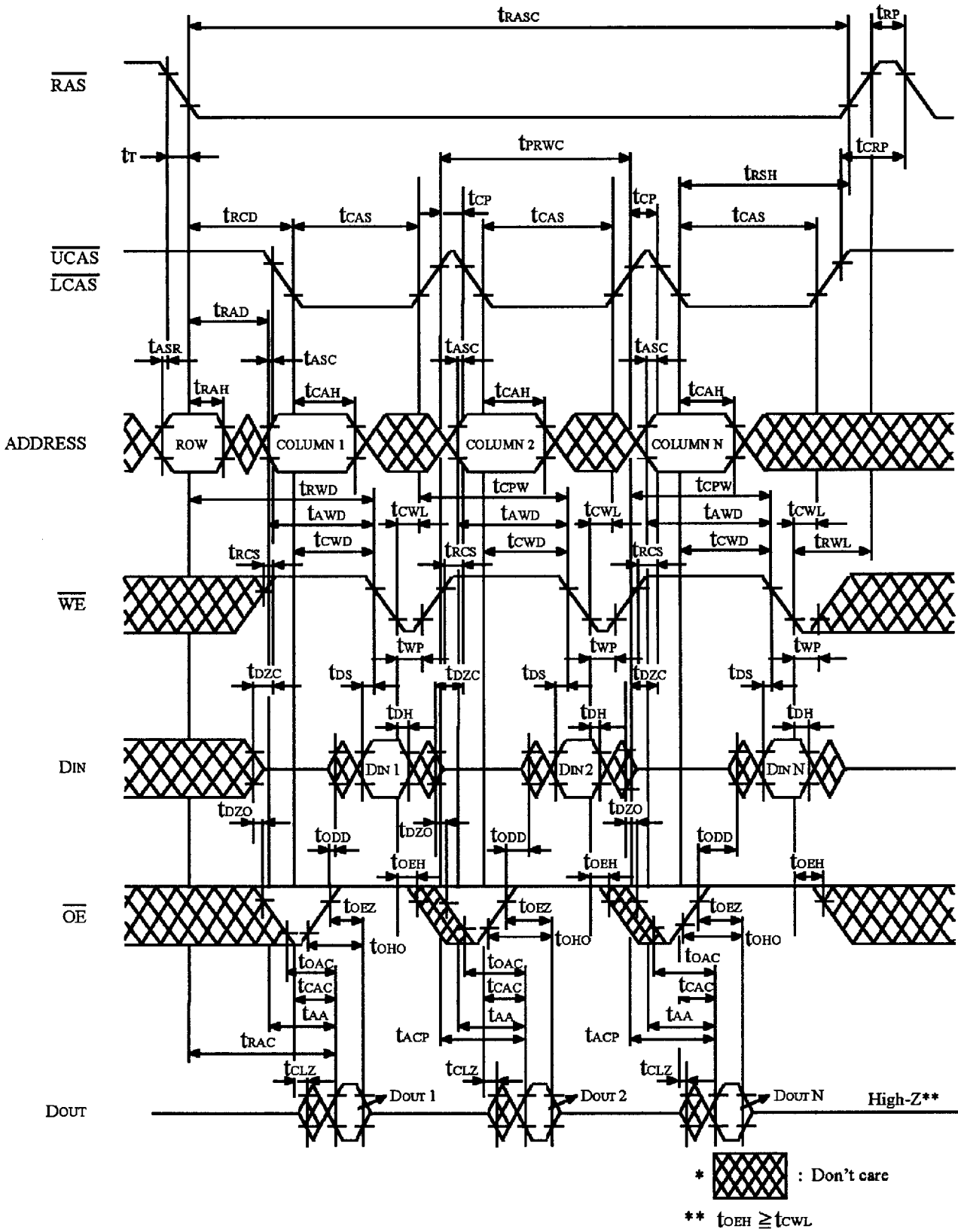

FIGURE 11. FAST PAGE MODE READ MODIFY WRITE CYCLE *19

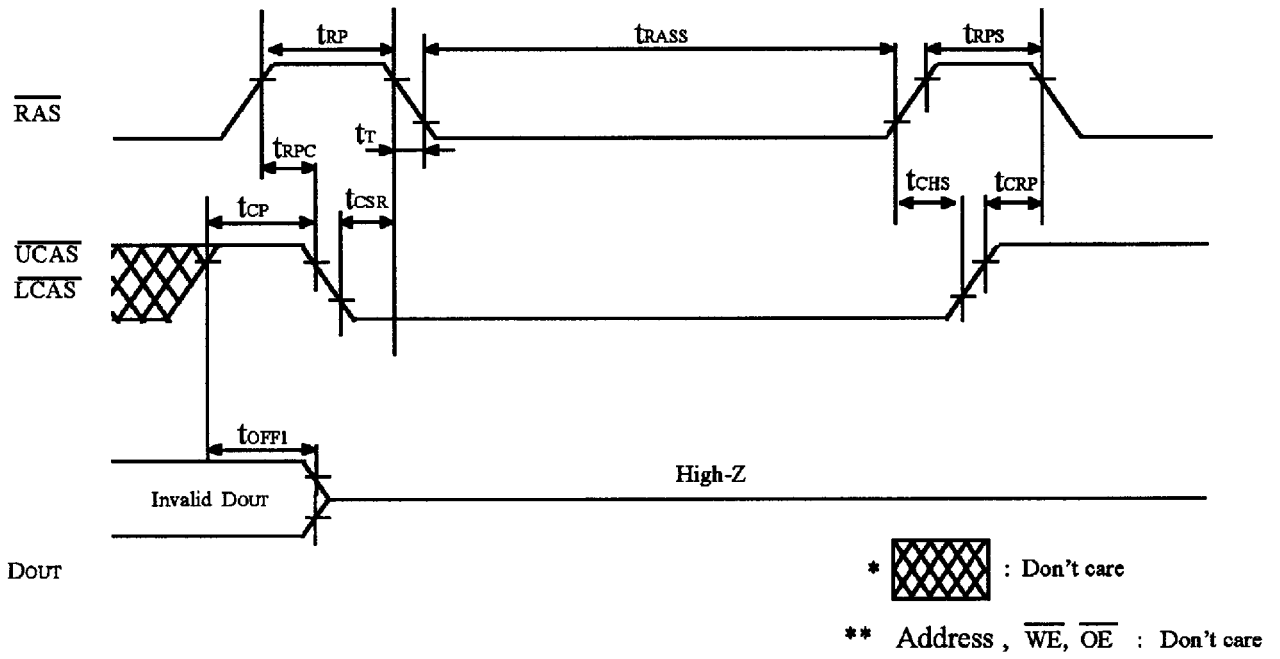
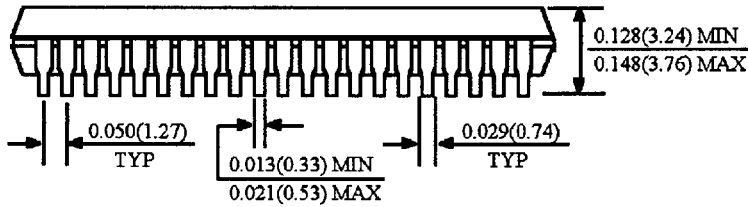
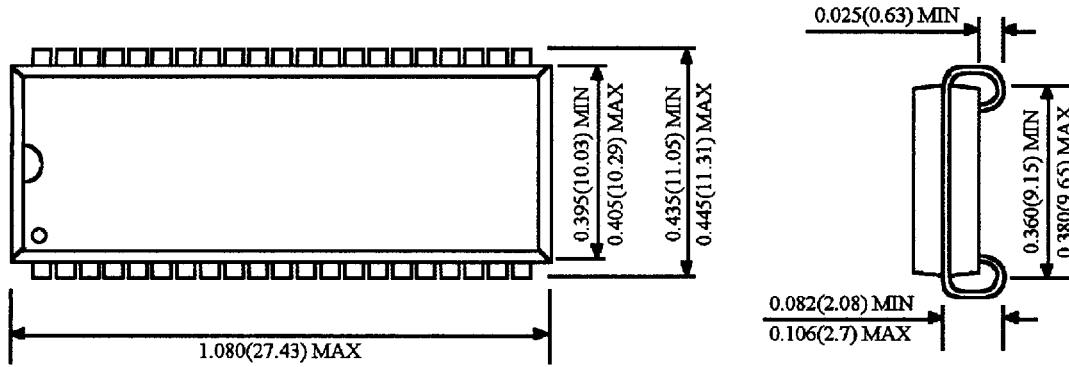

FIGURE 12. SELF-REFRESH CYCLE *26,27,28,29

Package Dimensions

Unit: Inches (mm)

42 SOJ



44(50) TSOP II

