

1 INTRODUCTION

The GNS3301 module supports GPS and GLONASS simultaneously. With a very small form factor of just 10.0 by 9.3 by 2.0 mm, GNS3301 is an ideal GNSS solution for many applications.

GNS 3301 is based on the advanced new generation MediaTek MT3333 GNSS chip. First Fixes after just a few seconds are achieved with the help of A-GPS using EPO™ (Extended Prediction Orbit) and the EASY™ “self generated orbit prediction” algorithm. EASY™ (Embedded Assist System) does not require any resources and does not need any information from the network.

Due to its capability to use GLONASS and GPS at the same time, GNS3301 benefits from the higher availability of satellites in critical environments.

The navigation performance and accuracy is further improved by using the correction data from SBAS (WAAS, EGNOS, GAGAN, MSAS), QZSS or DGPS(RTCM).

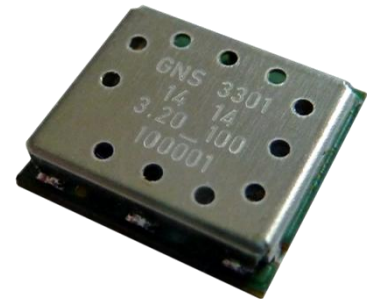

The low power design makes it easy to implement this module in power sensitive, battery supplied applications. Very low power requirements (typ 66mW@ 3.3V) and internal voltage regulator makes it easy to run the module with various power supplies and allows direct connection to LiIon batteries.

Further power savings are possible with AlwaysLocate™ power management feature. It adaptively adjusts power consumption depending on the environment and motion conditions, in order to achieve a balance between fix rate, power consumption and position accuracy.

In professional timing applications the outstanding high accuracy PPS (pulse per second) hardware pin is used for synchronization to GPS second. Typical accuracy is 10ns RMS jitter.

GNS3301 offers the industry's highest level of navigation sensitivity down to -165dBm. It has superior dynamic performance at high velocity and provides effective protection against interference signals using MTAIC™ (Multi-tone active interference canceller). Up to 12 independent channel interference continuous wave jammers can be eliminated or reduced.

The embedded logger function LOCUS with a 16-hrs on chip memory makes this GNSS module a complete track logger for many applications.

Features

- GLONASS and GPS simultaneously
- 99 acquisition-/ 33 tracking channels
- Ultra high tracking/navigation sensitivity: -165dBm
- Extremely fast TTFF at low signal level
- QZSS, SBAS (WAAS,EGNOS,MSAS,GAGAN) or DGPS(RTCM) correction support
- A-GPS by EPO "Extended Prediction Orbit"™ enables 7/14days prediction
- 12 Multitone Active Interference Canceller (MTAIC) for GPS-in-band jammer rejection
- EASY™ : Self generated orbit prediction support
- AlwaysLocate™ : Intelligent Algorithm for power saving
- Embedded logger function
- High accuracy 1PPS output
- NMEA-0183 or binary protocol
- High update rate (up to 10/s)
- GPS+GLONASS Consumption current(@3.3V):
 - Acquisition: 28mA typical
 - Tracking: 20mA typical
- Low backup current consumption 15uA, typical
- SMD type , stamp type adaptor available
- Small form factor: 10x9.3x2.0 mm

Applications

- Navigation
 - In-vehicle Navigation equipment
 - Dynamic Navigation
 - Portable ("nomadic") devices
 - Netbooks, tablet PCs and mobile phones
- Timing
 - Precision timing via GPS
- Location based applications
 - GPS Logger
 - GPS Tracker
 - Security devices
 - Camera equipment
 - Geofencing

2 INDEX

1 INTRODUCTION -----	1
2 INDEX -----	3
3 FUNCTIONAL DESCRIPTION -----	4
3.1 Block diagram -----	4
3.2 System description -----	4
3.3 GPS and GLONASS simultaneous operation -----	5
3.4 Power Management Features -----	5
3.5 Logger function -----	7
3.6 Active interference cancellation (MTAIC) -----	8
3.7 AGPS with EPO™ data -----	9
3.8 EASY™ self generated prediction data feature -----	10
3.9 Pulse Per Second (PPS) -----	10
3.10 SBAS (Satellite Based Augmentation) support -----	11
3.11 DGPS (Differential GPS) support -----	11
3.12 GPS almanac and ephemeris data -----	11
3.13 Real time clock (RTC) -----	11
3.14 UART interface -----	11
3.15 Module default settings -----	12
4 TYPICAL APPLICATION BLOCK DIAGRAM -----	13
4.1 Typical System overview -----	13
5 GNSS characteristics -----	14
5.1 GNSS characteristics -----	14
6 DESIGN GUIDELINES -----	15
6.1 General -----	15
6.2 GPS and GLONASS antenna -----	15
7 ELECTRICAL SPECIFICATION -----	16
7.1 Absolute Maximum Ratings -----	16
7.2 Recommended Operating Conditions -----	16
7.3 GPS/GLONASS input characteristics -----	16
8 DEVICE PINOUT DIAGRAM -----	17
8.1 Pin configuration -----	17
8.2 Pin assignment -----	18
9 NMEA DATA interface -----	19
9.1 NMEA output sentences for GPS and GLONASS -----	19
9.2 NMEA command interface -----	20
10 PHYSICAL DIMENSIONS -----	21
11 RECOMMENDED PAD LAYOUT -----	22
12 MATERIAL INFORMATION -----	23
13 RECOMMENDED SOLDERING REFLOW PROFILE -----	23
14 PACKAGE INFORMATION -----	24
15 TAPE&REEL INFORMATION -----	24
16 REEL INFORMATION -----	25
17 ORDERING INFORMATION -----	26
18 ENVIRONMENTAL INFORMATION -----	26
19 MOISTURE SENSITIVITY -----	27
20 DOCUMENT REVISION HISTORY -----	27
21 RELATED DOCUMENTS -----	27

3 FUNCTIONAL DESCRIPTION

3.1 Block diagram

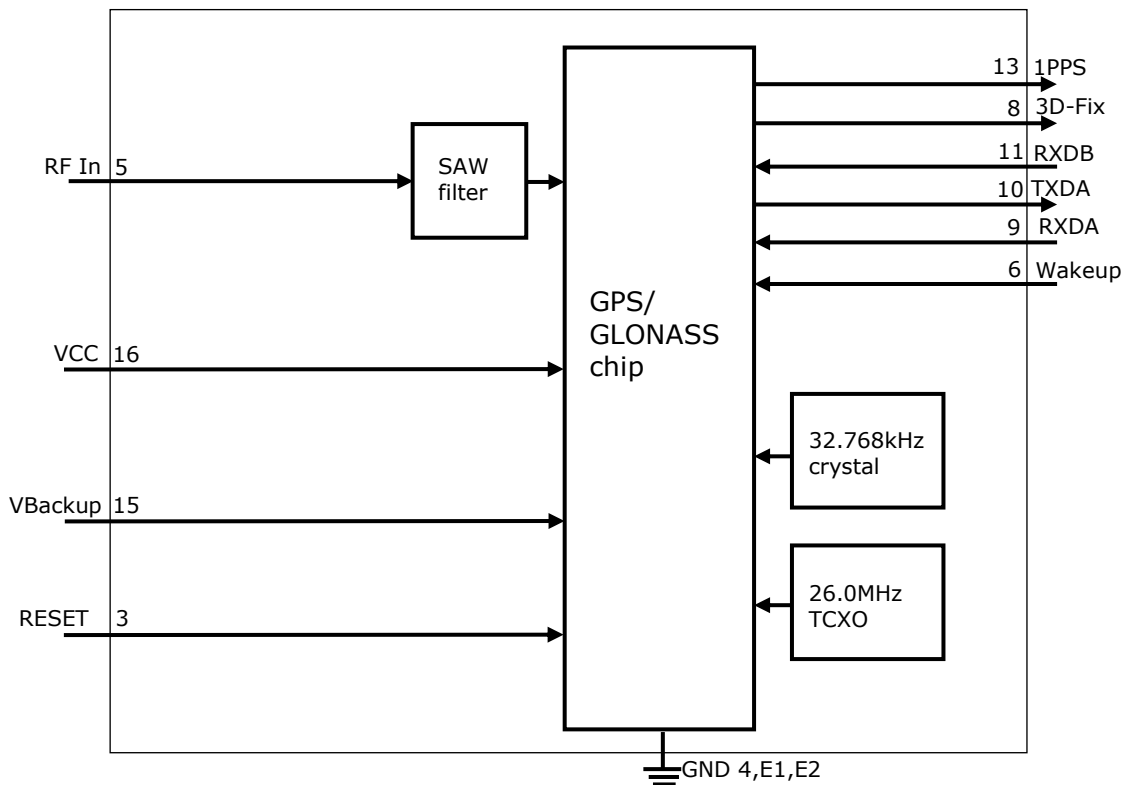

3.2 System description

The GNS3301 core is a high performance, low power GPS and GLONASS receiver that includes an integrated RF frontend. The receiver can process two GNSS systems simultaneously, which improves the availability of usable satellites in critical reception scenarios. Due to high input sensitivity it can work directly with a passive antenna.

GNS3301 is a complete GNSS engine, including:

- Full GPS and GLONASS processing without any host processing requirements
- Standard NMEA message output
- A powerful command and control interface
- All clock sources integrated on module
- RF frontend for direct connection of passive or active antennas
- Complete integrated logger function
- Interfaces for DGPS, PPS, Fix Status Indicator

3.3 GPS and GLONASS simultaneous operation

GNS3301 supports tracking of the GPS and the GLONASS satellite system at one time. This feature enhances the overall performance significantly.

- Increased availability of satellites
- Increased spatial distribution allows better geometrical conditions
- Reduced Horizontal (HDOP) and Vertical Dilution of Precision (VDOP) factors

In GPS-only operation, a minimum of 3 SVs is needed to determine a 2D position fix solution. When using both systems, 5 SVs are needed to determine the four unknowns and one more SV to calculate the GPS/GLONASS time offset.

Using a combined receiver, users have an access to potentially 48 or more satellites. This high number of satellites can overcome the typical problems of restricted visibility of the sky, such as in urban canyons or indoor scenarios.

3.4 Power Management Features

Power management schemes implemented for any GNSS system requires an optimally tuned performance for both accuracy of the position fixes and the average power consumed for best user experience. GNS3301 architecture achieves these both aspects by providing flexibility and design choices for the system integration, based on wide range of use cases and by leveraging on the proven silicon methodologies. Also GNS3301 provides position, velocity and time measurements without any host loading. This, coupled with the optional built-in power management options, reduces the overall system power budget.

Selectable Power management features:

- In **Standby mode** RF frontend and internal MPU are switched to deep sleep state. Power consumption is reduced to 0.6 mW (200µA). This state can be entered by sending the NMEA command: `$PMTK161,0*28<CR><LF>`. Leaving standby mode and resuming to normal operation will be managed by sending any byte to the module.

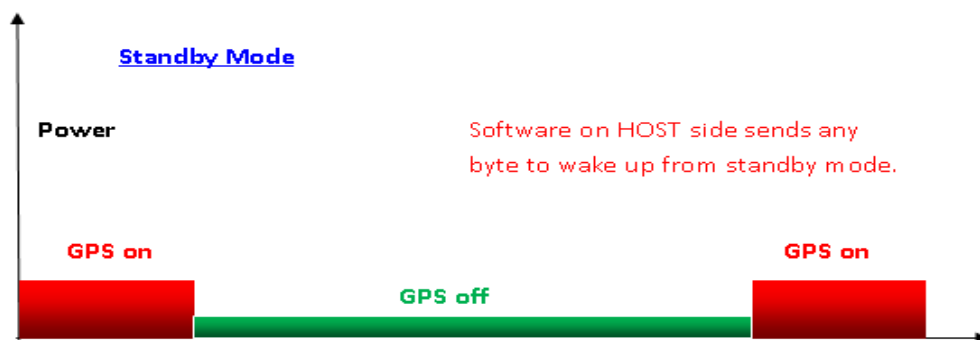

preliminary specification

- Backup mode** can be entered by sending NMEA command: \$PMTK225,4*2F<CR><LF>. The GPS/GLONASS core will shut down autonomously to backup state, Vcc supply can now be switched off by an external power supply switch.
- Periodic mode** describes a power mode, which will autonomously power on/off the module in programmable time slots with reduced fix rate. Periodic mode is useful during stationary operation or if position fixes are just needed from time to time. Since power consumption in **GPS off** times is nearly zero, the power consumption in periodic mode can be estimated by $P_{\text{tracking}} * (t_{\text{on}} / (t_{\text{on}} + t_{\text{off}}))$. Periodic mode is controlled with NMEA command \$PTMK225. See document *NMEA_Interface_manual_MTK_V..* for programming details.

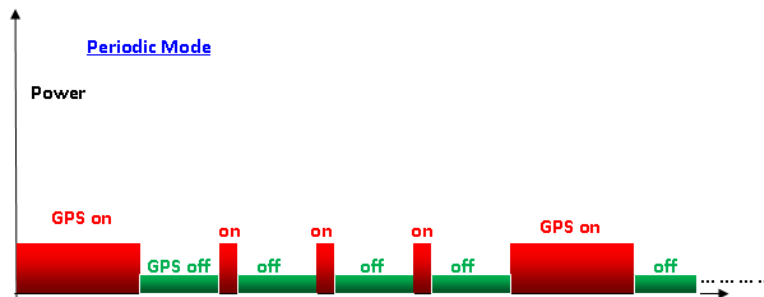

- AlwaysLocate™** feature provides an optimized overall GPS system power consumption in tracking mode under open sky conditions. Always Locate is an intelligent control of periodic mode. Depending on the environment and motion conditions, GNS3301 can adjust the on/off time to achieve balance of positioning accuracy and power consumption. The best power saving will be made under good reception in stationary mode. Critical reception conditions and dynamic movements will need full activity of the GNSS engine which causes nominal power requirements (22mA typ in tracking mode).

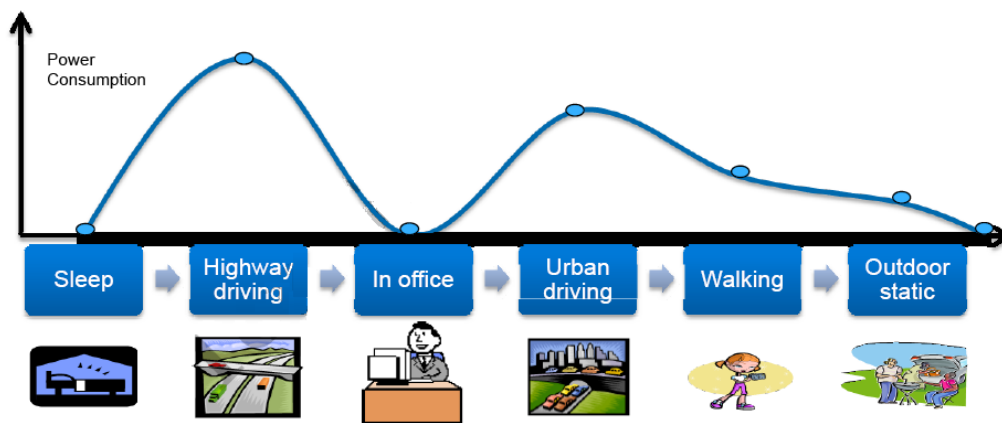

3.5 Logger function

GNS3301 provides an autonomous logger function that automatically stores position information in an internal 128kB flash memory. A complete tracking unit can be realized without any external CPU or memory.

The parameters for logging are programmable via the NMEA command interface. The following parameter can be set to optimize logging time:

- logger rate

The commands for logger include:

- start logging
- stop logging
- erase memory
- readout memory

please refer to the *NMEA_Interface_manual_MTK_V..* for details.

Internal Logger Function					
Logger data rate	1/32000		1	1/s	
Logger data memory		128		kBytes	Flash memory, allows ~8k of "basic" data sets
Logger capacity		~8000		positions	

Logger firmware options (on request) :

The logger is configured to record the "Basic" content by default.

Other content setting can be ordered as firmware options.

The following options can be statically defined by firmware build.

Please note that firmware options are bound to MOQ.

Logger content options

Name	Record size	Content									
		UTC	fixtype	Lat	Lon	Alt	speed	heading	hdop	satNo	Checksum
Basic	16	0	0	0	0	0					0
Racing	20	0	0	0	0	0	0	0			0
Search	19	0	0	0	0	0			0	0	0
Saving	13	0		0	0						0
All	23	0	0	0	0	0	0	0	0	0	0

Logger control and event options

Name	options	description	default
Logging mode	AL	Automatic logging	x
	FixOnly	Logging when fix is available	x
	Normal		
Interval setting	1..32,000 s	The interval for logging samples	5
Distance setting	1..50,000 m	Threshold condition. A log sample is taken when the position is changed by x meters	disabled
Speed setting	1..100 m/s	Threshold condition. A log sample is taken when the set speed is measured.	disabled
Memory option	Stop	Logging stops when memory is full	
	overlap	Logging continues from beginning when memory is full	x

3.6 Active interference cancellation (MTAIC)

Because different wireless technologies like Wi-Fi, GSM/GPRS, 3G/4G, Bluetooth are integrated into portable systems, the harmonic of RF signals may influence the GPS reception.

The multi-tone active interference canceller can reject external RF interference which come from other active components on the main board, thus improving the performance of GPS reception. GNS3301 can cancel up to 12 independent continuous wave (CW) channels having signal levels of up to -80dBm. The functionality is enabled by default and increases power consumption by about 1mA.

3.7 AGPS with EPO™ data

AGPS (assisted GPS) allows to shorten TTFF (TimeToFirstFix) by injecting ephemeris data from an external source into the module's memory. With the help of these data, the module does not need to acquire satellite positions by receiving the data from the satellites.

Depending on time and position information that is still available in the module memory, the TTFF can be reduced to just a few seconds.

The GNS AGPS service is based on a short term predicted data service. The predicted data will be fully processed by the GPS engine, the host must load the data from the web and transfer them over the UART to the module:

1. Check GNS3301 module EPO data for validity by comparing the time. (time parameters for existing 3301 data can be retrieved through a NMEA command)
2. Connect to web server through network connection (GPRS, WLAN, LAN,..)
3. Download file. There are just two files, covering all GPS satellites. The first file (MTK7d.EPO) is for 7 days (53kB), the other is 106Kbytes for 14 days (MTK14d.EPO)
4. "Parse" file, using software example. This is quite easy, there must be added some header bytes and a checksum and a control counter. GNS offers software support on this.
5. Download to GNS3301 module. please refer to the *NMEA_Interface_manual_MTK_V..* for details

If the host has low memory available, there's no need to save the whole file. The steps 3..5 can be done frame by frame needing less than 2kBytes of buffer memory.

Code samples and support for several platforms are available from GNS (in preparation)

Thanks to the predicted system, download data stay valid for up to 14 days. Therefore, users can initiate the download everytime and benefit from using (W)LAN instead of using expensive GSM. File size will be ~50kBytes for a one week prediction data set.

AGPS characteristics					
System					6hrs predicted data
File size for data download		53		kB	1 week prediction data
Maximum prediction time	7	14		days	
TTFF		1		sec	Time and last position available
TTFF		15		sec	Last position available

3.8 EASY™ self generated prediction data feature

GNS3301 includes an internal prediction system, that allows to sample satellite orbit data during operation and use that data to speed up TTFF on later starts. The prediction time frame is up to three days forward.

Although this prediction feature does not provide the very short TTFF that is achieved using AGPS, it can help to find a fix solution faster and in weak signal condition scenario. Prediction data will be kept in memory as long as V_{BACKUP} is present. This option is activated by default.

Note: The EASY functionality is only supported, if " V_{BACKUP} " pin is connected and the NMEA update rate is 1Hz.

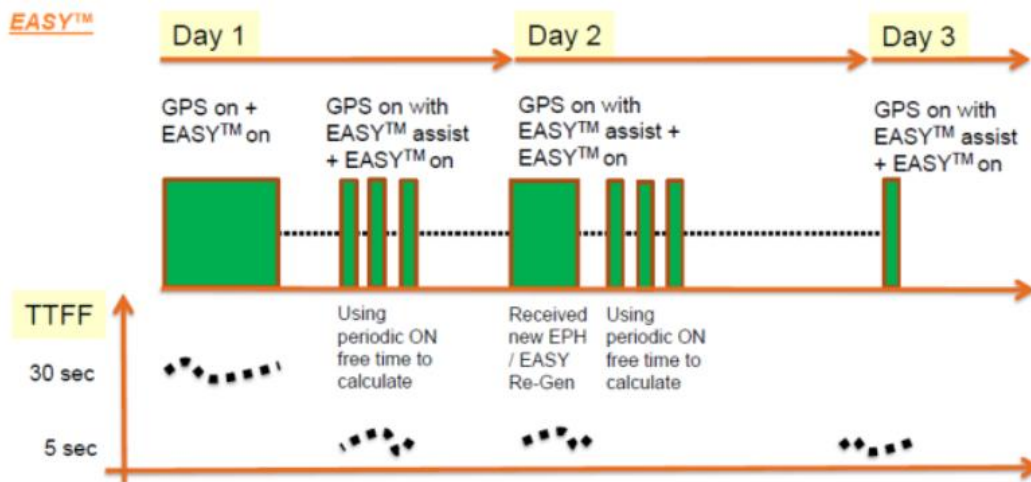

3.9 Pulse Per Second (PPS)

GNS3301 provides a Pulse Per Second (PPS) hardware output pin for timing purposes. After calculation of a 3D position fix (default setting), the PPS signal is accurately aligned to the GPS second boundaries. The pulse generated is approximately 100 milliseconds in duration and the repetition rate is 1 second. On request PPS output can be activated on a 2D- fix or after power-up of the module, providing a time accuracy decreased PPS signal.

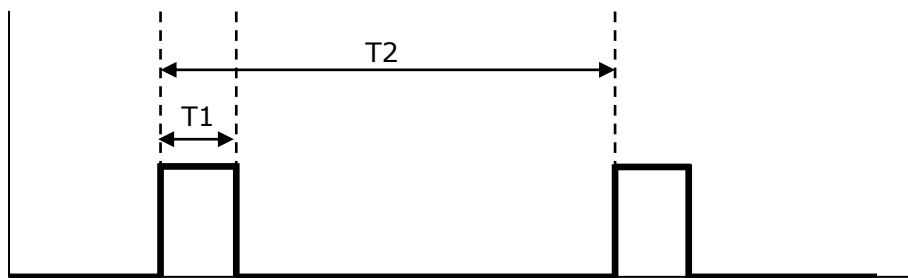

$$T1 = 100\text{ms} \quad T2 = 1\text{sec}$$

GNS3301 module provides an exceptionally low RMS jitter of typical 10 nanoseconds.

PPS characteristics based upon a 3D-fix					
1PPS pulse duration	-	100	-	msec	
1PPS time jitter	-	10		nsec RMS	Pulse rising edge deviation from expected pulse time, measured with full 3D fix
1PPS rise and fall time		5		nsec	10%..90%, load is 10k 5pF

3.10 SBAS (Satellite Based Augmentation) support

GNS3301 supports Satellite Based Augmentation for improvement of the navigation precision. Correction data is sent from geostationary satellites to the GPS receiver. GNS3301 supports European, US, and Asian augmentation systems (EGNOS, WAAS, QZSS, GAGAN, MSAS) to enable precision improvements in nearly every region of the world. SBAS is active by default and will automatically track the available SBAS satellites. It can be disabled by NMEA command. See document *NMEA_Interface_manual_MTK_V..* for details.

3.11 DGPS (Differential GPS) support

GNS3301 accepts DGPS input in RTCM format. DGPS provides precision position fixes down to centimetres and is used in professional applications like agriculture. The second UART (UART_B) of the module is used to feed the data in. DGPS is deactivated by default. For configuration of the UART port, some NMEA commands must be implemented. See *NMEA_Interface_manual_MTK_V..* document for details.

Note : Since SBAS and DGPS both do (different) corrections on the fix position solution, they cannot be used at the same time! SBAS / DGPS usage is programmed through the NMEA Interface.

3.12 GPS almanac and ephemeris data

For quick re-acquisition of the GPS after off-times, the GPS engine should have access to almanac and ephemeris data. This data is permanently stored inside GNS3301 module, even if all power supplies have been removed. When the GPS is powered-up again, the data will be used to allow a quick re-acquisition, as soon as a coarse time information is available. Time will be available immediately, when RTC is kept running.

3.13 Real time clock (RTC)

GNS3301 has a real time clock with 32,768Hz crystal onboard. As long as V_{BACKUP} is connected to a power source, the real time clock and the module memory can be kept alive at very low power consumption of just 7uA. The RTC will track the current time and enable the module to start from sleep states with very fast time to first Fix (TTF).

3.14 UART interface

GNS3301 core and I/O sections work at 3.3V nominal. Absolute Maximum Ratings should not be exceeded. Should the GNS3301 be interfaced to a host with I/O at higher/lower levels, level shifters should be used. UART baud rate is 9600baud by default. The baud rate can be modified to higher rates by a NMEA software command. See document *NMEA_Interface_manual_MTK_V..* for details.

GPS UART Default Settings	
Parameter	Value
Baud rate	9600
Data length	8 bits
Stop bit	1
Parity	None

3.15 Module default settings

The GNS3301 module comes with default settings, which are persistently programmed. Whenever power is removed from the module (both V_{CC} and V_{BACKUP}), the settings will be reset to the values shown in the following table.

Default settings	
Setting	Default value
UART setting	9600,8,N,1
Fix frequency (update rate)	1/sec
NMEA sentences	\$GPRMC,\$GNGSA,\$GPGSV,\$GLGSV,\$GPVTG,\$GPGGA
NMEA rate	Once a second: RMC,GSA,VTG every 5 sec :GSV sentences
Self survey prediction mode: EASY™	enabled
Active interference cancellation:MTAIC	enabled
DGPS option	SBAS enabled
Datum	WGS 84
PPS pulse output length	100ms
Logging parameters	cyclic / Content Basic / Interval 15 sec

On request, other options can be selected as preprogrammed (persistent default) options.
Please contact the GNS support for your project requirements.
Note : Customized options are solely available for fixed order lots.

4 TYPICAL APPLICATION BLOCK DIAGRAM

4.1 Typical System overview

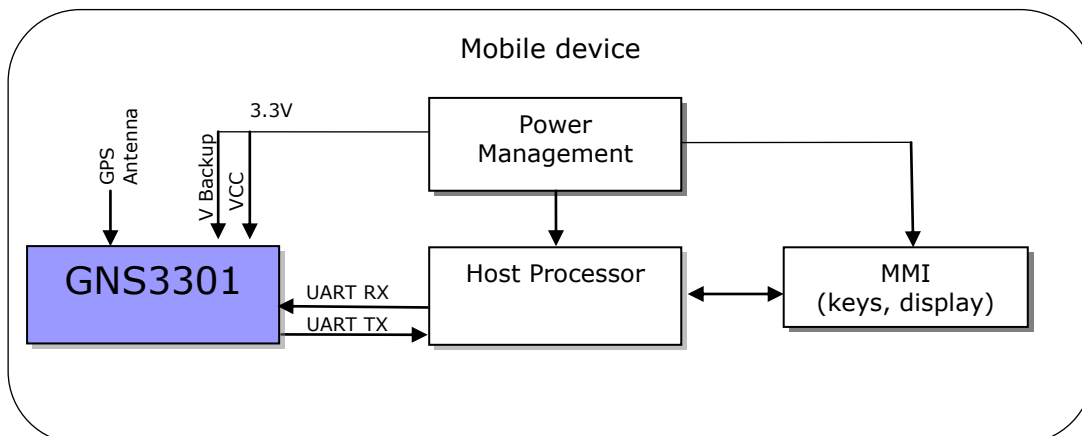

5 GNSS characteristics

5.1 GNSS characteristics					
Parameter	Min	Typ	Max	Unit	Note
general					
Frequency		1575.42		MHz	GPS L1
		1598.0625~ 1609.3125		MHz	GLONASS L1
SV Numbers					GPS #1~32 GLONASS #65~96 GALILEO #201~253*
DGPS					SBAS[QZSS,WAAS,EGNOS, MSAS,GAGAN], RTCM
AGPS					Internal processing of predicted orbit data. Service available via ftp. 6hrs prediction interval
Output data frequency	1/10	1	10	1/sec	Configurable
Navigation&tracking sensitivity		-165	-167	dBm	
Acquisition sensitivity		-148		dBm	autonomous
TTF hotstart		<1		sec	All SVs @-130dBm
TTF autonomous cold start		34		sec	All SVs @-130dBm
Number of channels tracking		33			
Number of acquisition channels		99			
Dimension		10x9.3x2.0		mm ³	Tolerance is 0.2 mm
Weight		0.41		g	
Power consumption					
GPS/GLONASS ACTIVE (acquisition)		28		mA	NMEA frequency = 1/sec*,SBAS enabled, MTAIC enabled
GPS/GLONASS ACTIVE (tracking)		20		mA	NMEA frequency = 1/sec*, SBAS enabled, MTAIC enabled
Backup current @ 3V		15		µA	

*note: further power savings are possible using AlwaysLocate or periodical modes. Actual possible savings depend on use cases.

Accuracy					
Position error CEP50	-	3	-	m	Without aid
Position error CEP50	-	2.5	-	m	Using (SBAS)
Velocity error	-	0.1	-	m/s	Without aid
velocity error	-	0.05	-	m/s	Using (SBAS)

ITAR limits					
Operation altitude		-	18,000	m	
Operation velocity	-	-	515	m/s	
Operation acceleration	-	-	4	G	

6 DESIGN GUIDELINES

6.1 General

Although GNS3301 GPS&GLONASS module provides best performance at low power consumption, special care should be taken to provide clean signal and clean power supplies. A multi layer carrier board with solid power- and ground planes is recommended. Power lines should be blocked near to the module with low ESR capacitors.

Radiated noise from neighbour components may also reduce the performance of the module. Special care must be taken when designing the RF input tracks and antenna connection.

6.2 GPS and GLONASS antenna

GNS3301 contains all input circuitry needed to connect a passive antenna directly. A special GNS & GLONASS antenna that covers both frequencies must be chosen.

If there is a long wire between GNS3301 RF input and antenna, there should be an LNA (on the antenna side) to compensate for cable losses ("active" antenna).

More information about connecting and implementing a GNSS antenna to an application PCB, please refer to *GPS Antenna Design Guide.pdf*.

7 ELECTRICAL SPECIFICATION

7.1 Absolute Maximum Ratings

Parameter	Value	Unit
Supply voltage range: V_{CC}	-0.5 to 4.3	V
Backup voltage: V_{BACKUP}	-0.5 to 4.3	V
Input voltage to analog pins	-0.5 to 3.3	V
Input voltage to all other pins	-0.5 to V_{CC}	V
Operating ambient temperature range	-40 to +85	°C
Storage temperature range	-40 to +85	°C

7.2 Recommended Operating Conditions

Parameter	Min	Typ	Max	Unit	Note
V_{CC}	2.8	3.3	4.3	V	supply voltage
V_{BACKUP}	2.8	3.3	4.3	V	Backup voltage for RTC and memory retention, must be available during normal operation
High level output voltage V_{OH}	$0.8 * V_{CC}$		V_{CC}	V	
Low level output voltage V_{OL}	0		$0.2 * V_{DD}$	V	
High-level input voltage V_{IH}	$0.80 * V_{CC}$		V_{CC}	V	
Low-level input voltage V_{IL}	0		$0.35 * V_{CC}$	V	
Operating temperature	-40		85	°C	Full specified sensitivity

7.3 GPS/GLONASS input characteristics

Parameter	Min	Typ	Max	Unit	Note
Maximum input level	0			dBm	
Input return loss		-6.5		dB	

8 DEVICE PINOUT DIAGRAM

8.1 Pin configuration

(TOP view)

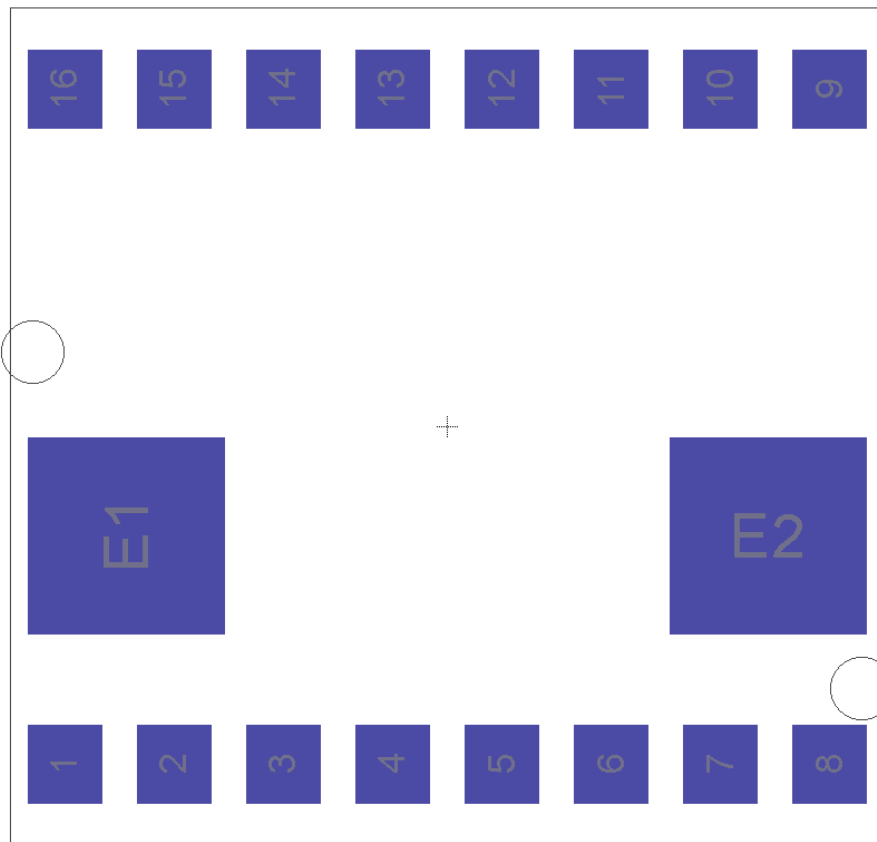

8.2 Pin assignment

Pin	Name	I/O	Description & Note
1	NC		Not connected
2	NC		Not connected
3	RESET	I	System reset pin An external reset applied to this pin overrides all other internal controls. RESET# is an active low signal. Pulling this pin low for at least 20 μ s causes a system reset.
4	RF_GND	A	RF Ground Ground connection of antenna should be connected at this pin.
5	RF_IN	A	RF input connection for GNSS antenna. Supports passive antenna.
6	WAKEUP	I	Wakeup input TBD
7	NC		Not connected
8	3D_FIX	O	3D-Fix Indicator The 3D_FIX is assigned as a fix flag output. If not used, keep floating. Before 2D Fix The pin will continuously toggle with 0.5 Hz. output one second high-level and one-second low-level signal After 2D or 3D Fix The pin will continuously output low-level signal This pin may not be connected to high-level at power-on sequence.
9	RXA	I	Serial Data Input A for NMEA command input (TTL) This is the UART-A receiver of the module. It is used to receive commands from system. UART A is also used for firmware update
10	TXA	O	Serial Data Output A for NMEA output (TTL) This is the UART-A transmitter of the module. It outputs GPS information for application. UART A is also used for firmware update
11	RXB (RTCM in)	I	Serial Data Input B This is the UART-B receiver of the module. It is used to receive RTCM data from system
12	NC		Not connected
13	1PPS	O	1PPS Time Mark Output This pin provides one pulse-per-second output from the module and synchronizes to GPS time. Keep floating if not used.
14	NC		Not connected
15	V _{BACKUP}	P	Backup power input for RTC & navigation data keep This connects to the backup power of the GPS module. Power source (such as battery) connected to this pin will help the GPS chipset in keeping its internal RTC running when the main power source is turned off. The voltage should be kept between 2.8V~4.3V, Typical 3.3V. current draw ~15 μ A If V _{BACKUP} power was not reserved, the GPS receiver will perform a lengthy cold start every time it is powered-on because previous satellite information is not retained and needs to be re-transmitted. This pin must be connected for normal operation.
16	VCC	P	Main DC power input The main DC power supply for the module. The voltage should be kept between from 2.8V to 4.3V. The ripple must be limited under 50mVpp (Typical: 3.3V).
E1	GND	P	Ground
E2	GND	P	Ground

(1) I = INPUT; O = OUTPUT; I/O = BIDIRECTIONAL; P = POWER PIN; ANA = ANALOG PIN.

9 NMEA DATA interface

GNS3301 provides NMEA 4.0 (National Marine Electronics Association) 0183 compatible data. A set of proprietary NMEA commands are available to send control messages to the module. These commands are described in a separate document: *NMEA_Interface_manual_MTK_V..* . For standard operation, no commands are needed; the module will start outputting NMEA sentences after power supply has been attached. GNS3301 will always start communication output with 9600 bit per second.

If non standard options are needed (f.e. other baud rate , other NMEA sequence) they can be programmed from host controller during runtime.

Important note : options set by using NMEA command interface are not persistent! They will be lost when power is removed. A backup supply at V_{BACKUP} will be sufficient to keep them.

9.1 NMEA output sentences for GPS and GLONASS

NMEA output sentences	
Type	content
Common sentences	
RMC	Recommended Minimum Navigation Information
GGA	Fix Data, Time, Position and fix related data for a GPS receiver
GLL	Geographic Position - Latitude/Longitude
GSA	GLONASS DOP and active satellites
VTG	Track made good and Ground speed
GSV	Satellites in view

NMEA output sentences identifier, related to its GNSS system:

NMEA output identifier					
System	GGA	GSA	GSV	RMC	VTG
GPS	GPGGA	GPGSA	GPGSV	GPRMC	GPVTG
GPS+GLONASS	GPGGA	GNGSA	GPGSV GLGSV	GPRMC ¹ or GNRMC	GPVTG

Note1: Before 3D fix RMC output is GPRMC, after 3D fix it changes to GNRMC.

9.2 NMEA command interface

GNS3301 NMEA command interface allows to control settings and the extended functions. The command interface specification is available in an extra document:

NMEA_Interface_manual_MTK_V.. .

Two groups of commands are available:

Setting commands do modify the behavior of the module.

Note : modified settings will be valid as long as the module is powered through VCC or V_{BACKUP}. (f.e. : setting of a new baud rate). After removing VCC and V_{BACKUP}, all settings are reset to their default values.

Action commands will perform the specified action one time after the command has been received. (f.e. : request for cold start)

Commands are always started with \$PTMK, directly followed by the command number 000..999. Each command must be terminated by *<checksum> and a <CR><LF>.

The checksum calculation is simple, just XOR all the bytes between the \$ and the * (not including the delimiters themselves). Then use the hexadecimal ASCII format.

10 PHYSICAL DIMENSIONS

TOP VIEW

all units in mm, tolerance is $\pm 0.2\text{mm}$

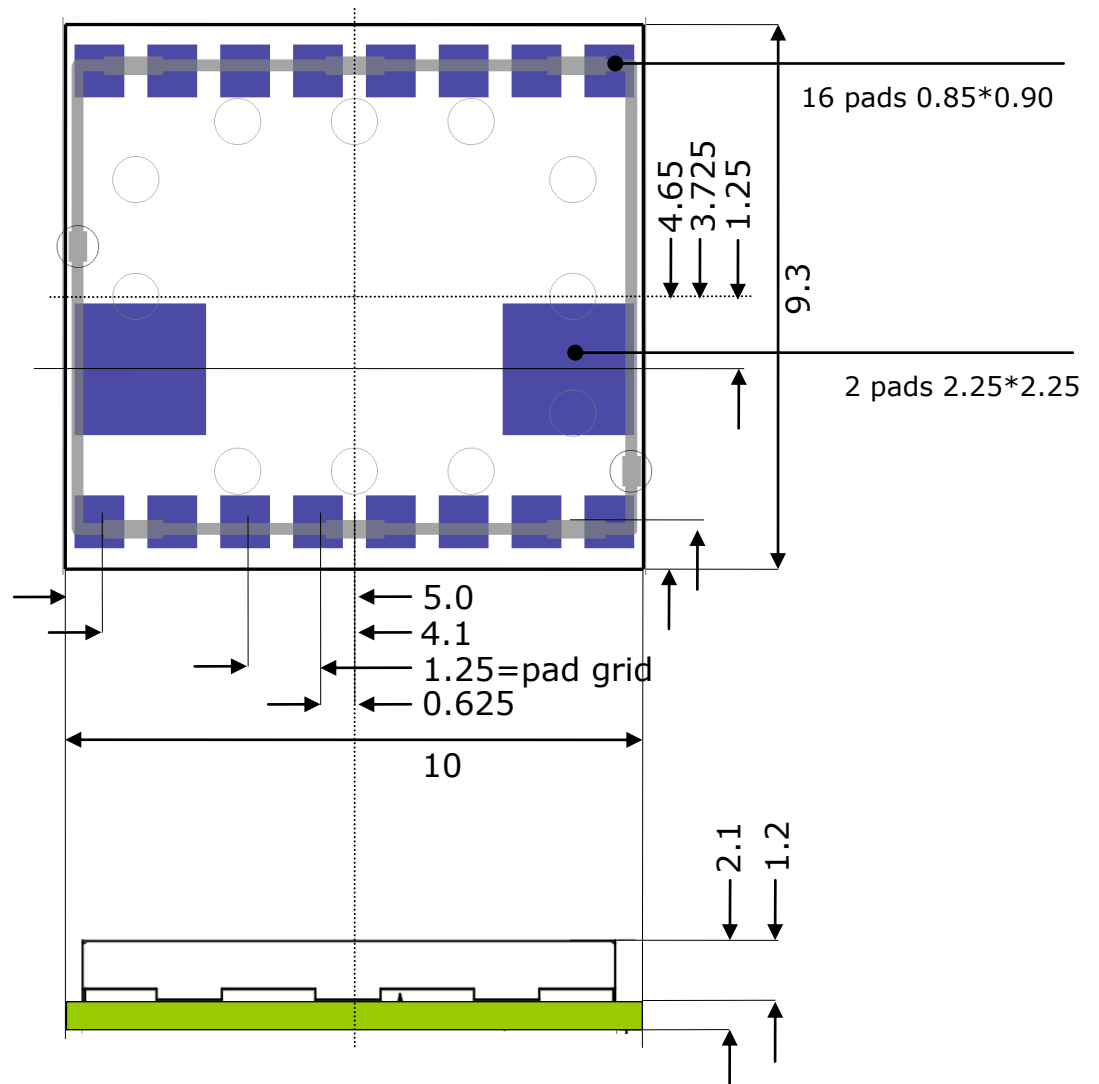

11 RECOMMENDED PAD LAYOUT

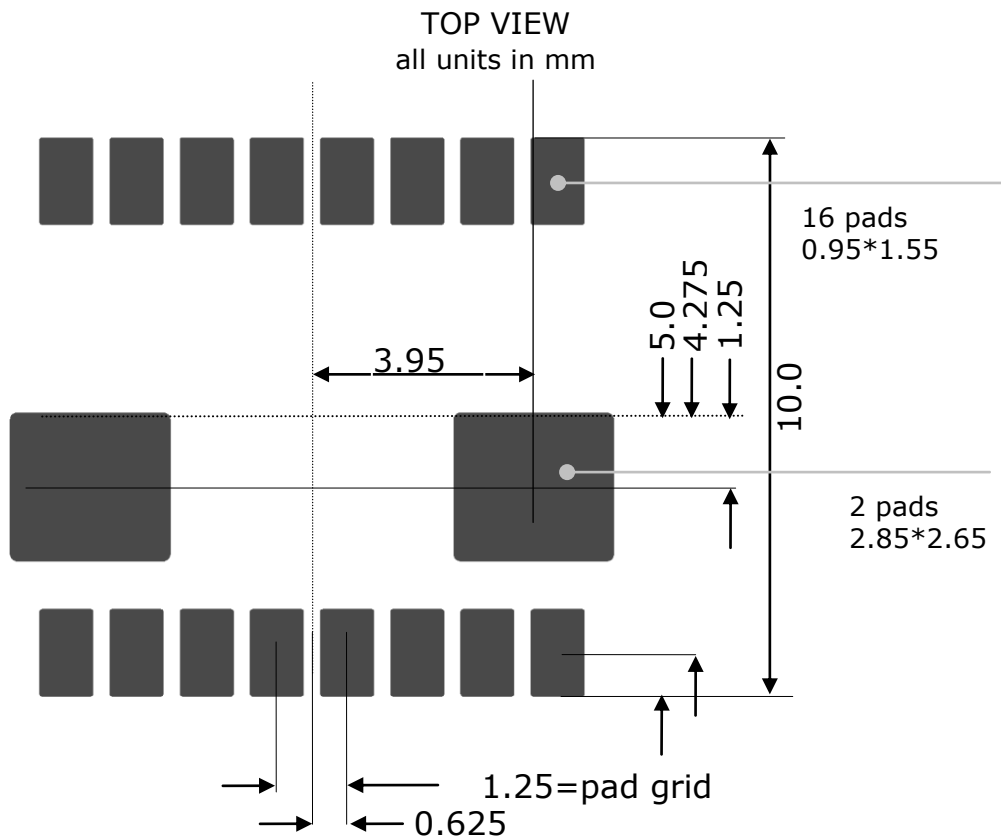

Note: For prototyping, GNS3301 is available on a stamp design adaptor board. Recommended mainboard pad layout will fit for both.

12 MATERIAL INFORMATION

Complies to ROHS standard
ROHS documentations are available on request
Contact surface: gold over nickel

13 RECOMMENDED SOLDERING REFLOW PROFILE

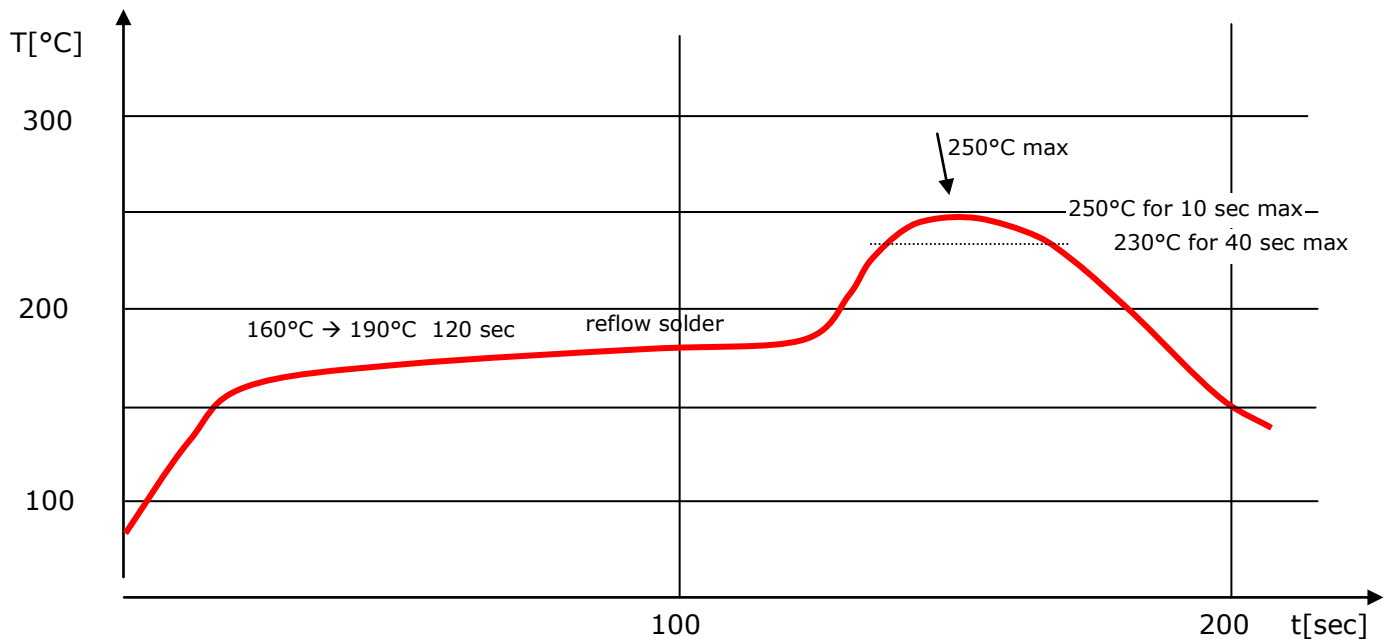

Notes:

1. GNS3301 should be soldered in upright soldering position. In case of head-over soldering, please prevent shielding / GNS3301 Module from falling down.
2. Do never exceed maximum peak temperature
3. Reflow cycles allowed : 1 time
4. Do not solder with Pb-Sn or other solder containing lead (Pb)
5. This device is not applicable for flow solder processing
6. This device is not applicable for solder iron process

14 PACKAGE INFORMATION

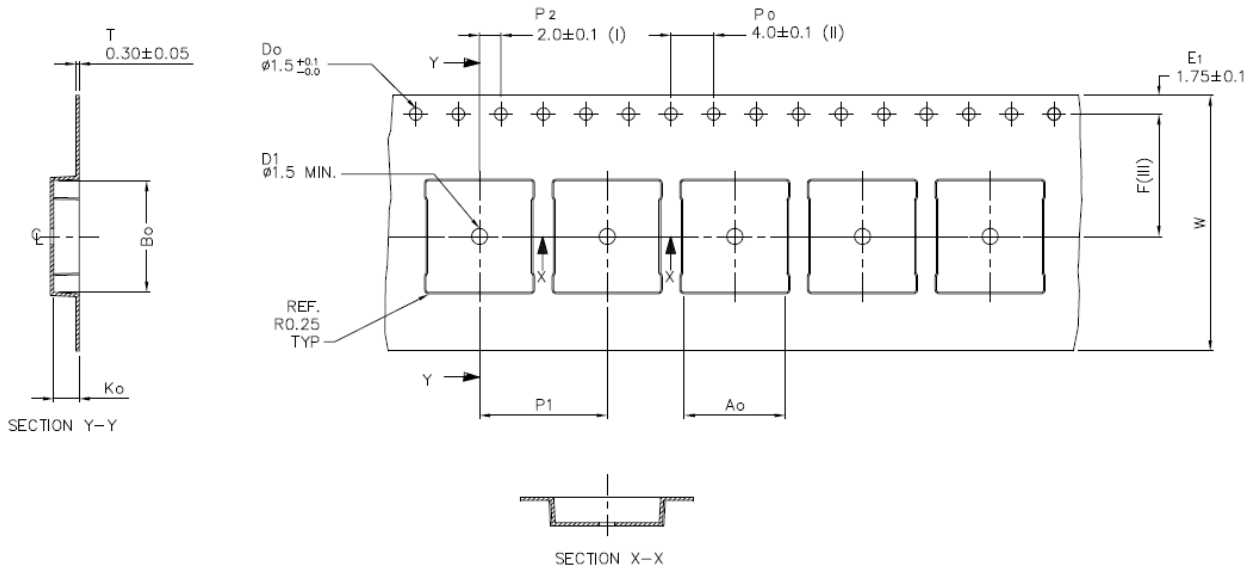

Ao	9.80	+/- 0.1
Bo	10.50	+/- 0.1
Ko	2.40	+/- 0.1
F	11.50	+/- 0.1
P1	12.00	+/- 0.1
W	24.00	+/- 0.3

Forming format : Flatbed
Estimated max. length : 60 meter/22B3 reel

- (I) Measured from centreline of sprocket hole to centreline of pocket.
- (II) Cumulative tolerance of 10 sprocket holes is ± 0.20 .
- (III) Measured from centreline of sprocket hole to centreline of pocket.
- (IV) Other material available.

ALL DIMENSIONS IN MILLIMETRES UNLESS OTHERWISE STATED.

GPS & GLONASS module GNS 3301

Datasheet

preliminary specification

16 REEL INFORMATION

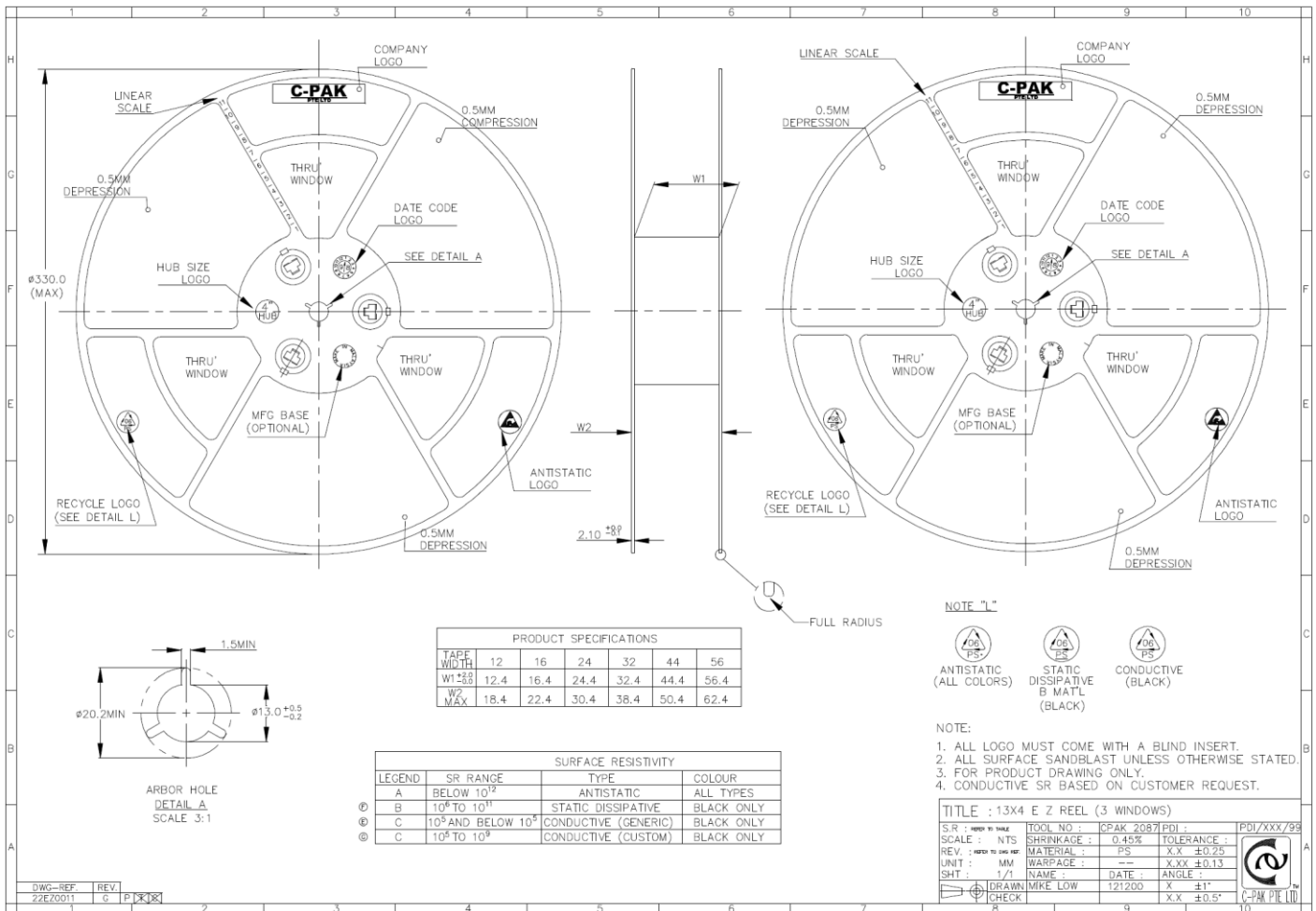

Number of devices: 2000pcs/reel

17 ORDERING INFORMATION

Ordering information			
Type	Part#	laser marking	Description
GNS3301	4037735105164	GNS 3301 ← Type 14 04 ← datecode 3.20_32 ← FW version 128245 ← serial#	GNS3301 GPS&GLONASS GNSS module

18 ENVIRONMENTAL INFORMATION

This product is free of environmental hazardous substances and complies with 2002/95/EC. (RoHS directive).



19 MOISTURE SENSITIVITY

This device must be prebaked before being put to reflow solder process.
Disregarding may cause destructive effects like chip cracking, which leaves the device defective !

Shelf life	6 months , sealed
Possible prebake recommendations	12 hrs @ 60°C
Floor life (time from prebake to solder process)	<72 hrs

20 DOCUMENT REVISION HISTORY

V0.0	March 17 2014	M.Reiff	initial preliminary
V0.1	May 22 2014	P.Skaliks	preliminary
V1.0	Sep 16 2014	P.Skaliks	Added logger information
V1.1	Oct 6 2014	P.Skaliks	added logger info, pad size
V1.2	Nov 14 2014	P.Skaliks	Corrected current consumption

21 RELATED DOCUMENTS

title	Description / file	Available from
<i>GPS Antenna Connection Design Guide</i>	Design Guide to implement an GPS antenna to an application PCB	www.forum.gns-gmbh.com
<i>NMEA_Interface_manual_MTK_V..</i>	Detailed description of NMEA protocol	www.forum.gns-gmbh.com www.gns-gmbh.com
<i>GNS3301 StarterKit user manual</i>	User manual for the GNS3301 receiver based evaluation kit	www.forum.gns-gmbh.com www.gns-gmbh.com