



DOCUMENT NUMBER AND REVISION

FS-GP001-JCG12832A05-01 REV. A
(FFPNNMNG-06-ST-NSC)

DOCUMENT TITLE:F
SPECIFICATION
OF
LCD MODULE TYPE

CUSTOMER	
MODEL NUMBER	GP001-JCG12832A05-01
CUSTOMER APPROVAL	
DATE	

DEPARTMENT	NAME	SIGNATURE	DATE
PREPARED BY	ZHU LING JUN		
CHECKED BY	XIE DAI ZHOU		
APPROVED BY	WANG ZHAO CAI		



DOCUMENT REVISION HISTORY 1:

DOCUMENT REVISION FROM TO	DATE	DESCRIPTION	CHANGED BY	CHECKED BY
A	2006.03.24	First Release.	ZHU LING JUN	XIE DAI ZHOU

CONTENTS

	<u>Page No.</u>
1. GENERAL DESCRIPTION	4
2. MECHANICAL SPECIFICATIONS	4
3. INTERFACE SIGNALS	7
4. ABSOLUTE MAXIMUM RATINGS	9
4.1 ELECTRICAL MAXIMUM RATINGS (Ta=25°C)	9
4.2 ENVIRONMENTAL CONDITION	10
5. ELECTRICAL SPECIFICATIONS	10
5.1 TYPICAL ELECTRICAL CHARACTERISTICS	10
5.2 TIMING SPECIFICATIONS	11
5.3 INSTRUCTUION TABLE	14
6. QUALITY UNITS	15

Specification of LCD Module Type
Item No.: GP001-JCG12832A05-01

1. General Description

- 128 x 32 Dots FSTN Positive Transflective Dot Matrix LCD Module.
- Viewing Angle: 6 O'clock direction.
- Driving duty: 1/33 Duty, 1/5 bias.
- 'SITRONIX' ST7565P LCD Controller & Driver or equivalent.
- Chip on Glass (COG).
- High-speed 8-bit MPU interface.
- Power Supply: +3.0V.
- FPC.
- Management Regulations for FindLCD's Environment –related Substances to be controlled (the detail is shown in Table1).

Table 1

NO.	The six kinds of content injurants (ppm) --- test way of ICP					
	Cadmium/cadmium compounds	Lead and lead compounds	Mercury and mercury compounds	Hexavalent chromium compounds	Polybrominated biphenyls (PBB)	Polybrominated diphenylethers (PBDE)
GP001	5	Plastic 100	100	100	100	100

Note: Substances for no listed in table must accord with the standard of JHD's Environment –related Substances to be controlled.

2. Mechanical Specifications

The mechanical detail is shown in Fig. 1 and summarized in Table 2 below.

Table 2

Parameter	Specifications	Unit
Outline dimensions	35.0 (W) x 16.9(H) x 1.8MAX.(D)(Exclude FPC) 35.0 (W) x 35.3(H) x 1.8MAX.(D)(Include FPC)	mm
Viewing area	32.00MIN (W) x 9.4MIN(H)	mm
Display format	128 x 32	dots
Dot size	0.202(W) x 0.235(H)	mm
Dot spacing	0.030(W) x 0.030(H)	mm
Dot pitch	0.232 (W) x 0.265 (H)	mm
Weight:	TBD	grams

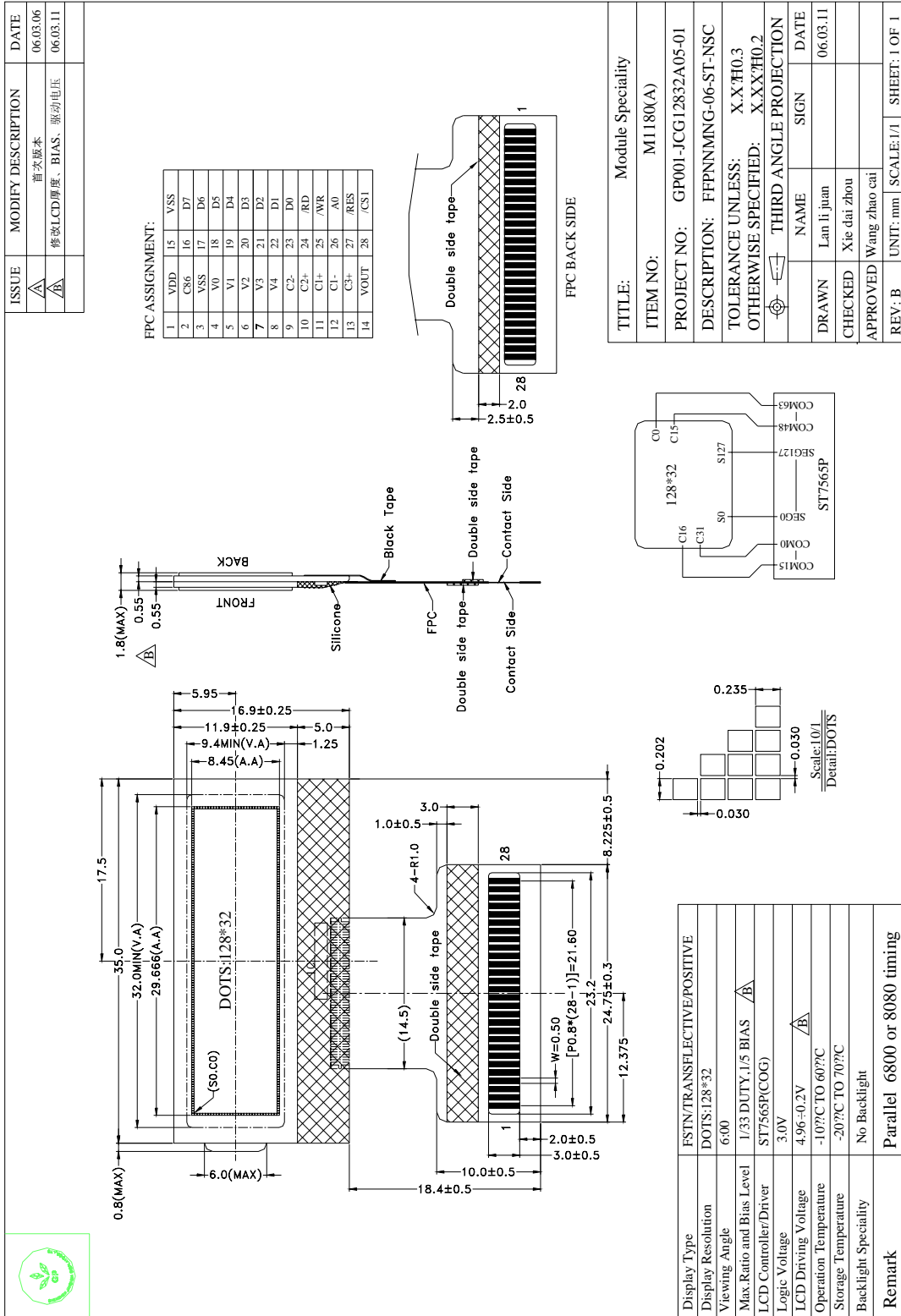
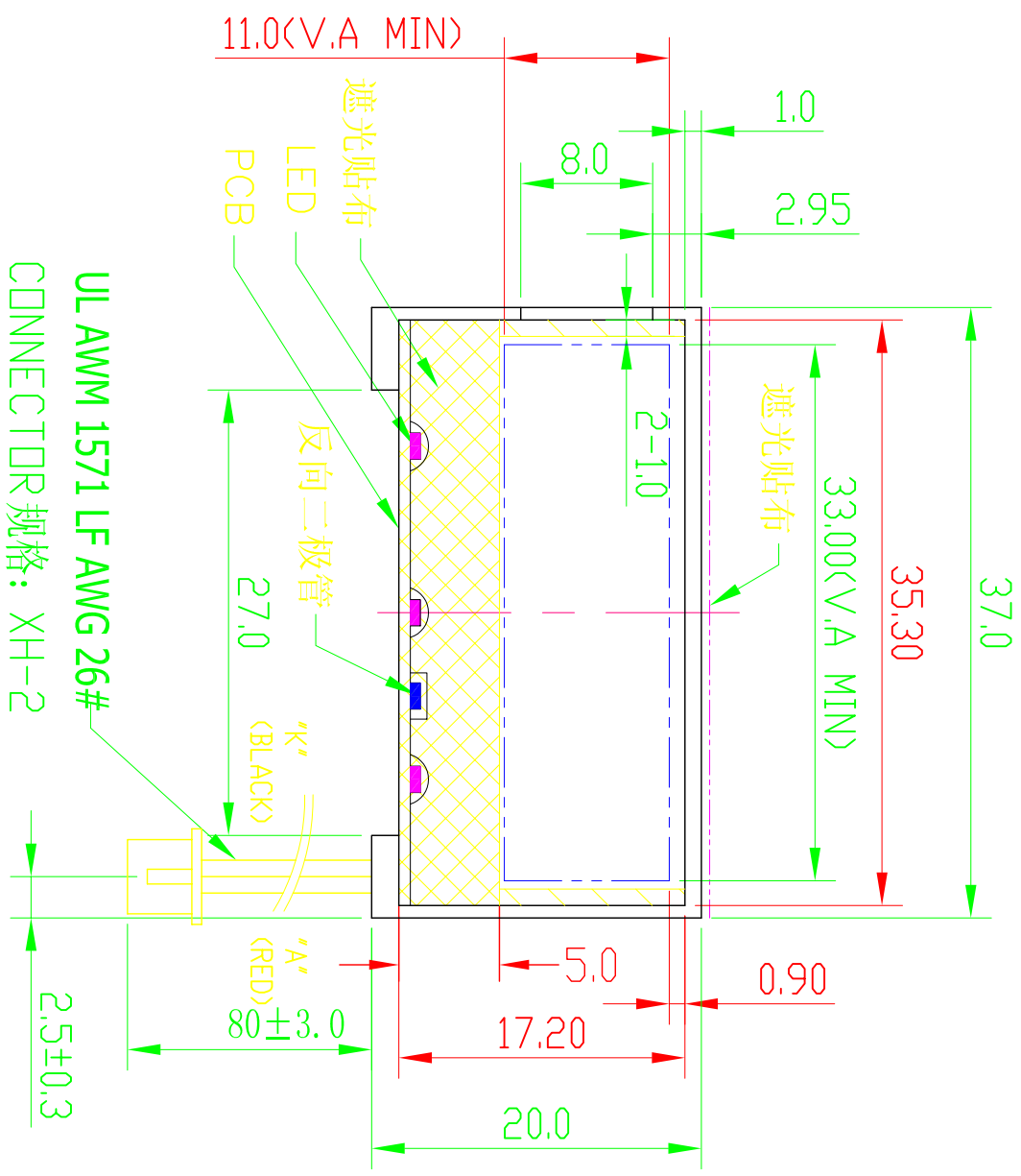

Figure 1: Module Specification



UL AWM 1571 LF AWG 26#
 CONNECTOR 规格: XH-2

www.FindLCD.com (2006.7.22)

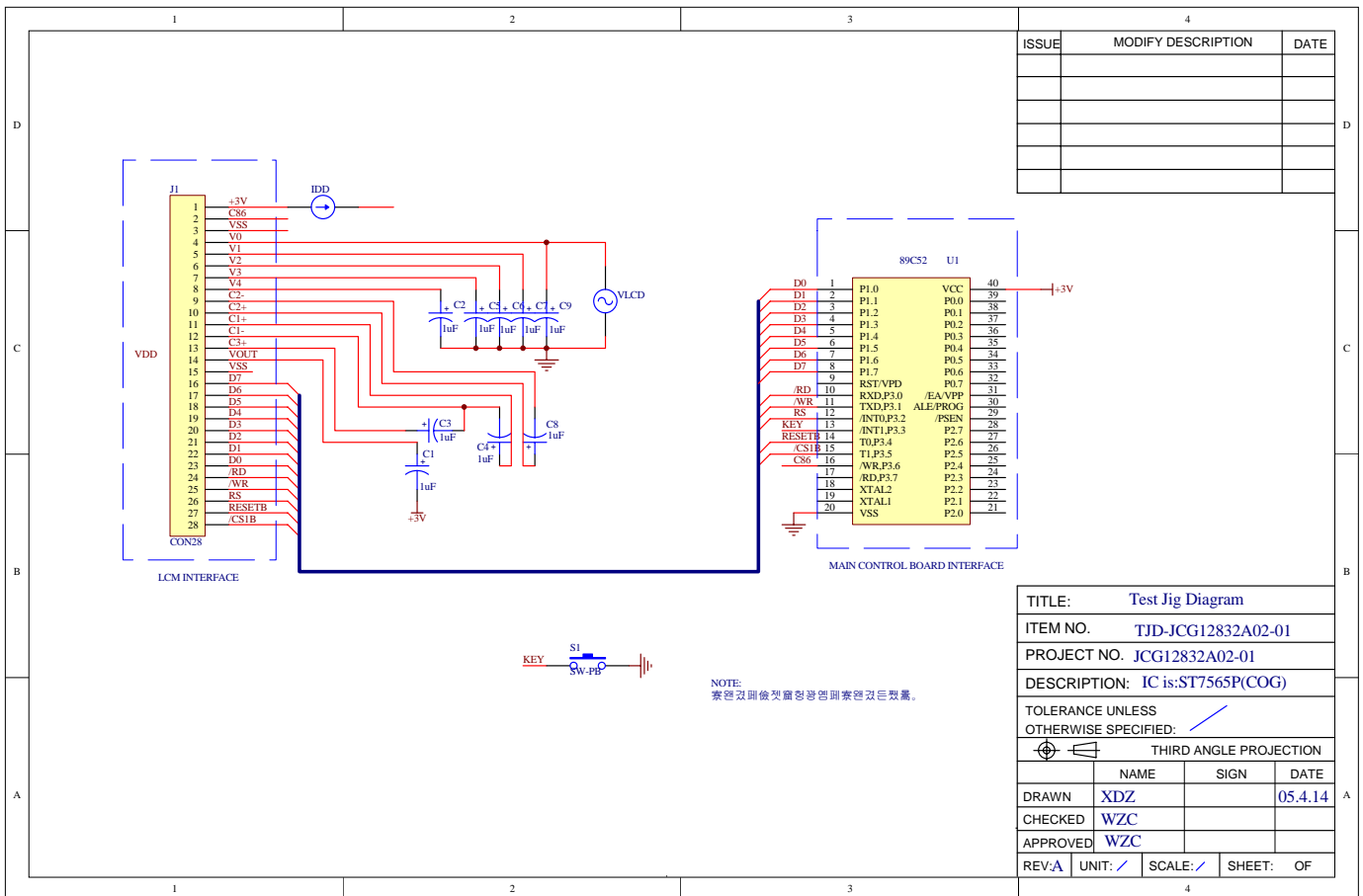

Figure 2: Recommend the outer circuit

3. Interface signals

Table 3(a)

Pin No.	Symbol	Description	
1	VDD	Power supply for logic +3.0V.	
2	C86	This is the MPU interface switch terminal. C86 = "H": 6800 Series MPU interface. C86 = "L": 8080 MPU interface.	
3	VSS	Ground (0V).	
4	V0	This is a multi-level power supply for the liquid crystal drive. The voltage supply applied is determined by the liquid crystal cell, and is changed through the use of a resistive voltage divider or through changing the impedance using an op. amp. Voltage levels are determined based on VSS, and must maintain the relative magnitudes shown below. $V0 \geq V1 \geq V2 \geq V3 \geq V4 \geq VSS$ When the power supply turns ON, the internal power supply circuits produce the V1 to V4 voltages shown below. The voltage settings are selected using the LCD bias set command. $V1=(1/5)V0, V2=(2/5)V1, V3=(3/5)V2, V4=(4/5)V0$	
5	V1		
6	V2		
7	V3		
8	V4		
9	C2-		DC/DC voltage converter. Connect a capacitor between this terminal and the C2+ terminal.
10	C2+		DC/DC voltage converter. Connect a capacitor between this terminal and the C2- terminal.
11	C1+		DC/DC voltage converter. Connect a capacitor between this terminal and the C1+ terminal.
12	C1-	DC/DC voltage converter. Connect a capacitor between this terminal and the C1- terminal.	
13	C3+	DC/DC voltage converter. Connect a capacitor between this terminal and the C1- terminal.	
14	VOUT	DC/DC voltage converter. Connect a capacitor between this terminal and VSS or VDD	
15	VSS	Ground (0V).	
16	D7	This is an 8-bit bi-directional data bus that connects to an 8-bit or 16-bit standard MPU data bus. When the serial interface is selected (P/S = "L"): D7 : serial data input (SI) ; D6 : the serial clock input (SCL). D0 to D5 are set to high impedance. When the chip select is not active, D0 to D7 are set to high impedance.	
17	D6		
18	D5		
19	D4		
20	D3		
21	D2		
22	D1		
23	D0		
24	/RD	<ul style="list-style-type: none"> • When connected to an 8080 MPU, this is active LOW. (E) This pin is connected to the /RD signal of the 8080 MPU, and the ST7565P series data bus is in an output status when this signal is "L". • When connected to a 6800 Series MPU, this is active HIGH. This is the 6800 Series MPU enable clock input terminal.	

Table 3(b)

Pin No.	Symbol	Description
25	/WR	<ul style="list-style-type: none"> • When connected to an 8080 MPU, this is active LOW. (R/W) This terminal connects to the 8080 MPU /WR signal. The signals on the data bus are latched at the rising edge of the /WR signal. • When connected to a 6800 Series MPU: This is the read/write control signal input terminal. When R/W = "H": Read. When R/W = "L": Write.
26	A0	<p>This is connect to the least significant bit of the normal MPU address bus, and it determines whether the data bits are data or a command. A0= "H": Indicates that D6, D7 are display data. A0= "L": Indicates that D6, D7 are control data.</p>
27	/RES	<p>When /RES is set to "L," the settings are initialized. The reset operation is performed by the /RESB signal level.</p>
28	/CS1	<p>This is the chip select signal. When /CS1 = "L" and CS2 = "H," then the chip select becomes active, and data/command I/O is enabled.</p>

4. Absolute Maximum Ratings

4.1 Electrical Maximum Ratings (Ta = 25 °C)

Table 4

Parameter	Symbol	Min.	Max.	Unit
Power Supply voltage (Logic)	VDD - VSS	-0.3	+5.0	V
Power Supply voltage (LCD drive)	V0, VOUT	-0.3	+18.0	V
	V1, V2, V3, V4	V0	+0.3	V

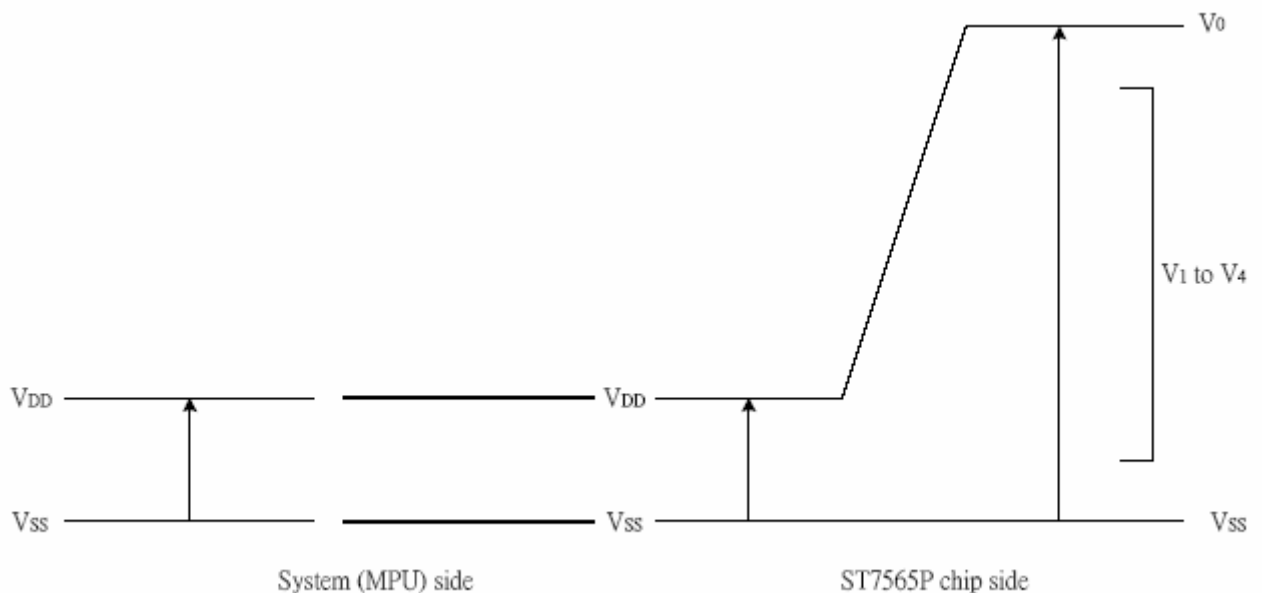

Note:

The modules may be destroyed if they are used beyond the absolute maximum ratings.

1. All voltage values are referenced to VSS = 0V.
2. Insure that the voltage levels of V1, V2, V3, and V4 are always such that

$$VOUT \geq V0 \geq V1 \geq V2 \geq V3 \geq V4.$$

4.2 Environmental Condition

Table 5

Item	Operating Temperature (Topr)		Storage Temperature (Tstg)		Remark
	Min.	Max.	Min.	Max.	
Ambient Temperature	-10°C	+60°C	-20°C	+70°C	Dry

5. Electrical Specifications

5.1 Typical Electrical Characteristics

At Ta = 25 °C, VDD = 3.0V±0.1V, VSS=0V.

Table 6

Parameter	Symbol	Conditions	Min.	Typ.	Max.	Unit
Supply voltage (Logic)	VDD-VSS		2.9	3.0	3.1	V
Supply voltage (LCD)	VLCD = V0-VSS	VDD =+3.0V, Note 1	5.2	5.4	5.6	V
Input signal voltage for A0,/RD,/WR,D0---D7, /CS1, /RES, C86 pins.	V _{IH}	“H” level	0.8VDD	-	VDD	V
	V _{IL}	“L” level	VSS	-	0.2VDD	V
Supply Current (Logic & LCD)	IDD	Note 1	-	0.4	0.6	mA

Note 1: There is tolerance in optimum LCD driving voltage during production and it will be within the specified range.

5.2 Timing Specifications

At $T_a = -10^{\circ}\text{C}$ To $+60^{\circ}\text{C}$, $V_{DD} = +3.0\text{V} \pm 0.1\text{V}$, $V_{SS} = 0\text{V}$.

Refer to Fig. 3, the bus timing diagram for the 8080 series MPU.

Table 7

Item	Signal	Symbol	Condition	Rating		Units
				Min.	Max.	
Address hold time	A0	t_{AH8}		0	—	Ns
Address setup time		t_{AW8}		0	—	
System cycle time		t_{CYC8}		240	—	
Enable L pulse width (WRITE)	WR	t_{CCLW}		80	—	
Enable H pulse width (WRITE)		t_{CCHW}		80	—	
Enable L pulse width (READ)	RD	t_{CCLR}		140	—	
Enable H pulse width (READ)		t_{CCHR}		80	—	
WRITE Data setup time	D0 to D7	t_{DS8}		40	—	
WRITE Address hold time		t_{DH8}		0	—	
READ access time		t_{ACC8}	$CL = 100\text{ pF}$	—	70	
READ Output disable time		t_{OH8}	$CL = 100\text{ pF}$	5	50	

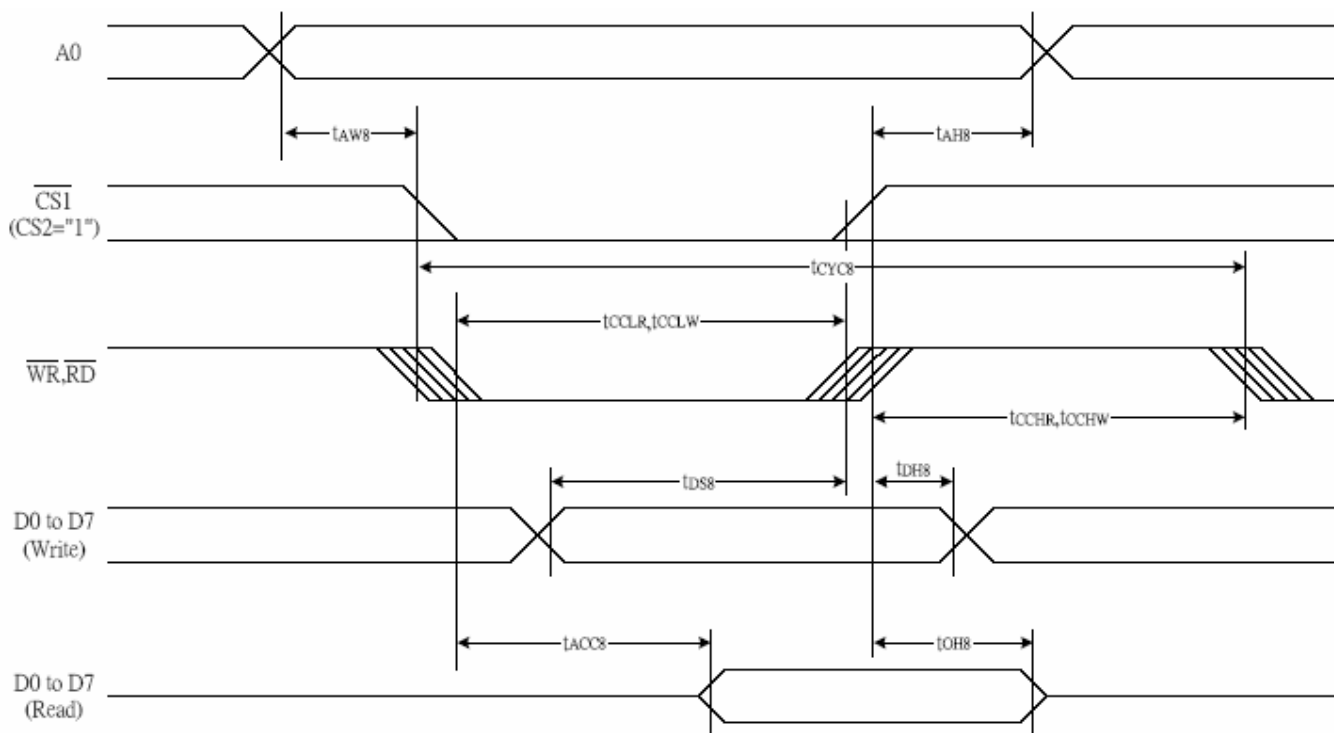

Figure 3: The 8080 series MPU timing

At $T_a = -10^{\circ}\text{C}$ To $+60^{\circ}\text{C}$, $V_{DD} = +3.0\text{V} \pm 0.1\text{V}$, $V_{SS} = 0\text{V}$.

Refer to Fig. 4, the bus timing diagram for the 6800 series MPU.

Table 8

Item	Signal	Symbol	Condition	Rating		Units
				Min.	Max.	
Address hold time	A0	t_{AH6}		0	—	ns
Address setup time		t_{AW6}		0	—	
System cycle time		t_{CYC6}		240	—	
Enable L pulse width (WRITE)	WR	t_{EWLW}		80	—	
Enable H pulse width (WRITE)		t_{EWHW}		80	—	
Enable L pulse width (READ)	RD	t_{EWLR}		80	—	
Enable H pulse width (READ)		t_{EWHR}		140	—	
WRITE Data setup time	D0 to D7	t_{DS6}		40	—	
WRITE Address hold time		t_{DH6}		0	—	
READ access time		t_{ACC6}	CL = 100 pF	—	70	
READ Output disable time		t_{OH6}	CL = 100 pF	5	50	

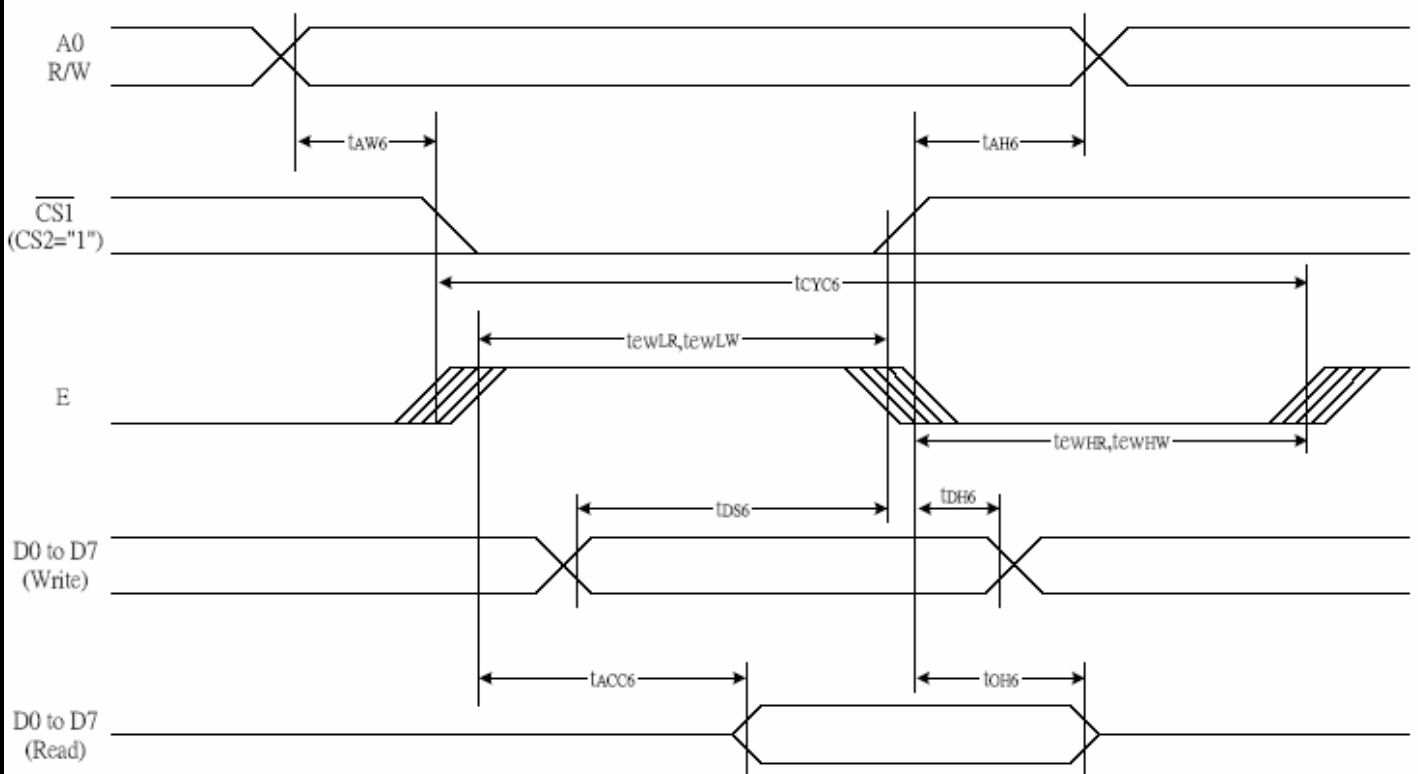

Figure 4: The 6800 series MPU timing

At $T_a = -10\text{ }^{\circ}\text{C}$ To $+60\text{ }^{\circ}\text{C}$, $V_{DD} = +3.0\text{V} \pm 0.1\text{V}$, $V_{SS} = 0\text{V}$.

Refer to Fig. 5, the bus timing diagram for reset timing.

Table 9

Item	Signal	Symbol	Condition	Rating			Units
				Min.	Typ.	Max.	
Reset time		t_R		—	—	1.0	us
Reset "L" pulse width	/RES	t_{RW}		1.0	—	—	us

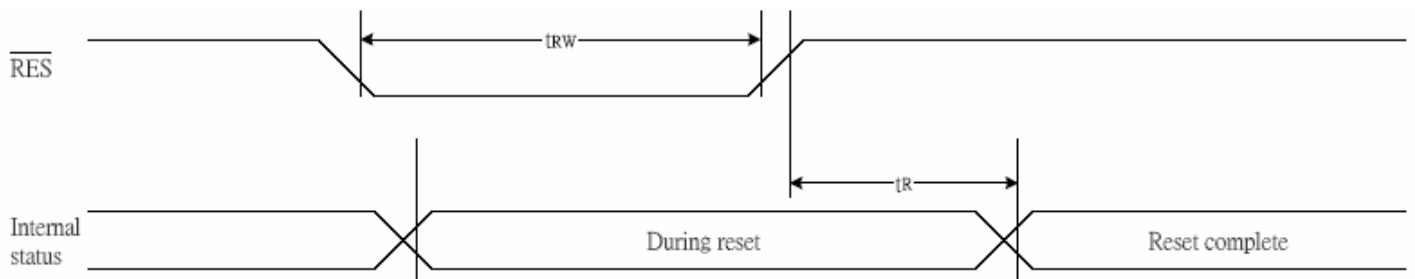

Figure 5: Reset Timing

- Note: 1. All timing is specified with 20% and 80% of VDD as the standard.
2. The input signal rise and fall time (t_r , t_f) are specified at 15 ns or less.

5.3 Instruction Table

Table 10

Command	Command Code								Function				
	A0	/RD	/WR	D7	D6	D5	D4	D3		D2	D1	D0	
(1) Display ON/OFF	0	1	0	1	0	1	0	1	1	1	0	1	LCD display ON/OFF 0: OFF, 1: ON
(2) Display start line set	0	1	0	0	1	Display start address						Sets the display RAM display start line address	
(3) Page address set	0	1	0	1	0	1	1	Page address				Sets the display RAM page address	
(4) Column address set upper bit	0	1	0	0	0	0	1	Most significant column address				Sets the most significant 4 bits of the display RAM column address.	
Column address set lower bit	0	1	0	0	0	0	0	Least significant column address				Sets the least significant 4 bits of the display RAM column address.	
(5) Status read	0	0	1	Status				0	0	0	0	0	Reads the status data
(6) Display data write	1	1	0	Write data								Writes to the display RAM	
(7) Display data read	1	0	1	Read data								Reads from the display RAM	
(8) ADC select	0	1	0	1	0	1	0	0	0	0	0	0	Sets the display RAM address SEG output correspondence 0: normal, 1: reverse
(9) Display normal/reverse	0	1	0	1	0	1	0	0	1	1	0	1	Sets the LCD display normal/reverse 0: normal, 1: reverse
(10) Display all points ON/OFF	0	1	0	1	0	1	0	0	1	0	0	1	Display all points 0: normal display 1: all points ON
(11) LCD bias set	0	1	0	1	0	1	0	0	0	1	0	1	Sets the LCD drive voltage bias ratio 0: 1/9 bias, 1: 1/7 bias (ST7565P)
(12) Read/modify/write	0	1	0	1	1	1	0	0	0	0	0	0	Column address increment At write: +1 At read: 0
(13) End	0	1	0	1	1	1	0	1	1	1	0	0	Clear read/modify/write
(14) Reset	0	1	0	1	1	1	0	0	0	1	0	0	Internal reset
(15) Common output mode select	0	1	0	1	1	0	0	0	*	*	*	*	Select COM output scan direction 0: normal direction 1: reverse direction
(16) Power control set	0	1	0	0	0	1	0	1	Operating mode			Select internal power supply operating mode	
(17) V ₀ voltage regulator internal resistor ratio set	0	1	0	0	0	1	0	0	Resistor ratio			Select internal resistor ratio(Rb/Ra) mode	
(18) Electronic volume mode set	0	1	0	1	0	0	0	0	0	0	0	1	Set the V ₀ output voltage electronic volume register
Electronic volume register set	0	1	0	0	0	Electronic volume value							
(19) Static indicator ON/OFF	0	1	0	1	0	1	0	1	1	0	0	0	0: OFF, 1: ON
Static indicator register set	0	1	0	0	0	0	0	0	0	0	0	0	Mode
(20) Booster ratio set	0	1	0	1	1	1	1	1	0	0	0	0	select booster ratio 00: 2x,3x,4x 01: 5x 11: 6x
(21) Power saver													Display OFF and display all points ON compound command
(22) NOP	0	1	0	1	1	1	0	0	0	1	1	1	Command for non-operation
(23) Test	0	1	0	1	1	1	1	*	*	*	*	*	Command for IC test. Do not use this command

6. Quality Units

- The Soldering Temperature is 260±5°C and Soldering Time should be less than 3 sec, and soldering iron power should be less than 30W.
- The soldering point should be farther than 1.6mm from body .
- 焊接温度 260°C±5°C, 焊接时间小于 3 秒, 烙铁功率小于 30W.
- 焊接点应离产品实体大于 1.6 mm.

4. 极限参数 ABSOLUTE MAXIMUM RATINGS (除非特别说明, 环境温度 Ta=25°C. Unless specified, The Ambient temperature Ta=25°C)

项目 Item	符号 Symbol	条件 Conditions	值 Rating	单位 Unit
* 极限直流正向电流 Absolute maximum forward current	Ifm		20*3	mA
* 脉冲驱动时极限正向电流 Peak forward current	Ifp	1 msec 脉冲, 1/10 占空比 1 msec Plus 10% Duty Cycle	60*3	mA
反向电压 Reverse Voltage	Vr		3	V
* 极限功耗 Power dissipation	Pd		75*3	mW
工作温度 Operating Temperature Range	Topr		-30~+70°C	°C
贮存温度 Storage Temperature Range	Tstg		-40~+80°C	°C

* 当工作温度高于 25°C 时, Ifm, Ifp 和 Pd 必须降低; 电流降低率是 0.36*3 mA/°C (直流驱动), 或 0.86*3 mA/°C (脉冲驱动), 功耗降低率是 0.75*3 mW/°C. 产品的工作电流不能大于对应工作温度条件 Ifm 或 Ifp 的 60%.

For operation above 25°C, The Ifm Ifp & Pd must be derated, the Current derating is 0.36*3 mA/°C for DC drive and 0.86*3 mA/°C for Pulse drive, the Power dissipation is 0.75*3 mW/°C. The product working current must not more than the 60 % of the Ifm or Ifp according to the working temperature.

电, 光特性 ELECTRICAL-OPTICAL CHARACTERISTICS (除非特别说明, 环境温度 Ta=25°C. Unless specified, The Ambient temperature Ta=25°C)

项目 Item	符号 Symbol	最小值 min.	典型值 typ.	最大值 max.	单位 Unit	测定条件 Condition
正向电压 Forward Voltage	Vf	2.9	3.2	3.5	mA	If= 45 mA
反向电流 Reverse Current	Ir			15	μA	Vr= 3 V
峰值波长 Peak wave length	λp				nm	If= 45 mA
频谱半宽度 Spectral line Half width	Δλ				nm	If= 45 mA
* 亮度 Luminance	Lv				cd/m²	If= 45 mA
* 均匀性 Lumin/Lvmax		65			%	If= 45 mA

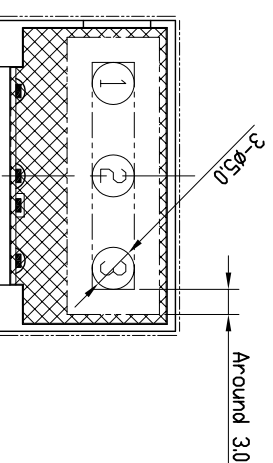

* 亮度值是 3 个测量点的平均值, 使用 BM-7 亮度色度仪测量, 测量光圈 φ 5 mm.

The luminance is the average value of 3 points, The measurement instrument is BM-7 luminance, Colorimeter. The aperture is φ 5 mm.

6. STATIC ELECTRICITY AND SURGE (静电、击穿)

* **Static electricity and surge will damage the LEDs.** It is recommended to use a wrist band or anti-electrostatic glove when handling the LEDs. (静电冲击损坏发光二极管, 在处理LED时推荐使用静电手环、手指套)

* All devices, equipment and machinery must be properly grounded. (所有设备外壳必须接地)

* When inspecting own final products on which LEDs were mounted, it is recommended to check also whether the mounted LEDs are damaged by static electricity or not. It is easy to find static-damaged LEDs by light emission test at lower current (below 1mA is recommended).

Damaged LEDs will show some unusual characteristics such as leak current remarkably increases, starting forward voltage becomes lower, or the LEDs get unlighted at the low current. (在检查带有LED背光产品时, 建议检验LED是否被静电损坏, 在很低电流下通过点亮试验就能发现发光二极管(LED)被损坏 (一般推荐1mA以下) 损坏的LED呈现的特性: 反向漏电流增大、正向电压偏低、低电流时不亮)

7. RECOMMEND CONNECTION OF STATIC-ELECTRICITY RESISTANCE

* This circuit diagram is a common ESD protection circuit for all super bright blue, white and green color LED backlight application.

8. LED ELECTRICAL CHARACTERISTICS

(1) 正向电流-周围温度

Forward Current VS. Ambient Temperature

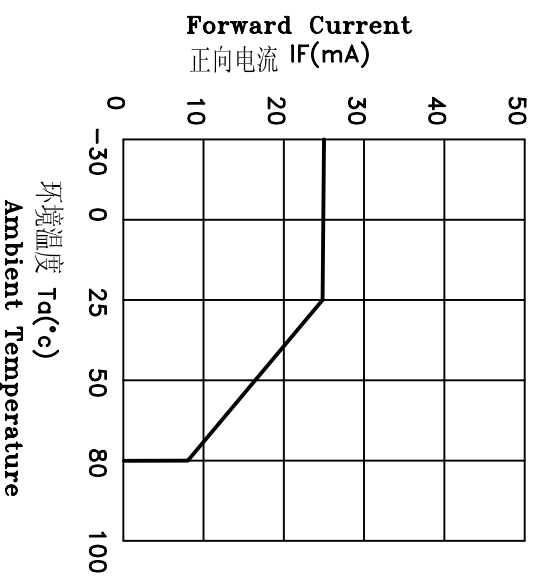

(2) 正向电流-正向电压特性

Forward Current VS. Forward Voltage

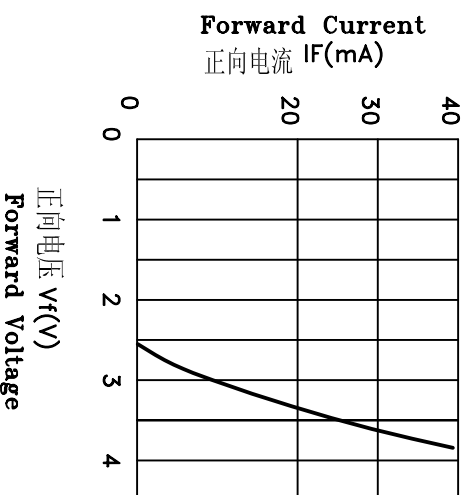

9. 色度坐标 CHROMATICS COORDINATES

X : 0.265-0.325

Y : 0.270-0.335

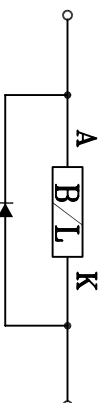

Protective Diode