

APPLICATION NOTE

VACUUM FLUORESCENT DISPLAY MODULE

GRAPHIC DISPLAY MODULE

GP1209A04A

FUTABA GP1209A04A is a graphic display module using a FUTABA 112×16 VFD.

Consisting of a VFD, display drivers and a control circuit, the module can be driven by connecting to the host system through a simple interface.

Important Safety Notice

Please read this note carefully before using the product.

Warning

- The module should be disconnected from the power supply before handling.
- The power supply should be switched off before connecting or disconnecting the power or interface cables.
- The module contains electronic components that generate high voltages (approx. 32V) which may cause an electrical shock when touched.
- Do not touch the electronic components of the module with any metal objects.
- The VFD used on the module is made of glass and should be handled with care. When handling the VFD, it is recommended that cotton gloves be used.
- The module is equipped with a circuit protection fuse.
- Under no circumstances should the module be modified or repaired. Any unauthorized modifications or repairs will invalidate the product warranty.
- The module should be abolished as the factory waste.

CONTENTS

1. FEATURES	1
<hr/>	
2. GENERAL SPECIFICATIONS	
2-1. OUTER DIMENSION, WEIGHT	1
2-2. DISPLAY SPECIFICATION	1
2-3. ENVIRONMENTAL CONDITIONS	1
2-4. ABSOLUTE MAXIMUM RATINGS	2
2-5. RECOMMENDED OPERATION CONDITIONS	2
2-6. ELECTRICAL OPTICAL CHARACTERISTICS	2
<hr/>	
3. INTERFACE	
3-1. COMMUNICATION	3
3-2. RESET TIMING	4
<hr/>	
4. DISPLAY SPECIFICATION	
4-1. DISPLAYABLE IMAGE TYPES	5
4-2. DISPLAY MEMORY	5
4-3. WINDOW	6
4-4. WRITE SCREEN MODE FOR “BASE-WINDOW”	7
4-5. CHARACTER DISPLAY FORMAT	8
<hr/>	
5. FUNCTION	
5-1. COMMANDS	9~24
<hr/>	
6. SETUP	
6-1. JUMPER	25
<hr/>	
7. CONNECTOR	
7-1. CASE OF ASYNCHRONOUS SERIAL INTERFACE IS SELECTED	26
7-2. CASE OF SYNCHRONOUS SERIAL INTERFACE IS SELECTED	26
<hr/>	
FIGURE-1 MECHANICAL DRAWING	27
<hr/>	
FIGURE-2 BLOCK DIAGRAM	28
<hr/>	
7-3. FONT TABLE	29
<hr/>	
8. WARRANTY	33
<hr/>	
9. CAUTIONS FOR DETERMINING AND EXPORTING REGULATED GOODS OR SERVICES	33
<hr/>	
10. CAUTIONS FOR OPERATION	33
<hr/>	
11. THE ENVIRONMENTAL SPENIFICATIONS FOR THIS PRODUCT SERVICES	34
<hr/>	

1. FEATURES

- 1-1. High quality and long life can be achieved with FUTABA CIG-VFD.
- 1-2. Being equipped with CPU and PSU.
- 1-3. It realizes displaying 5×7 dots character by Serial interface (It is selectable either CMOS synchronous or Asynchronous interface).

2. GENERAL SPECIFICATIONS

2-1. Outer Dimension, Weight (Refer to page 27)

Table- 1

Item	Specification	Unit
Outer dimension	(W) 80.0±1	mm
	(H) 38.0±1	
	(T) 15.9 Max.	
Weight	Approx. 30	g

2-2. Display Specification

Table- 2

Item	Specification	Unit
Display Area	52.5 (W)×11.45 (H)	mm
Number of Pixels	112(W)×16 (H)	DOT
Dot Size	0.33 (W)×0.575 (H)	mm
Dot Pitch	0.47 (W)×0.725 (H)	mm
Color of Illumination	Green(λ p=505nm)	—

2-3. Environmental Conditions

Table- 3

Item	Symbol	Min.	Max.	Unit
Operating Temperature	<i>Topr</i>	-20	+70	°C
Storage Temperature	<i>Tstg</i>	-40	+85	°C
Operating Humidity (Note)	<i>Hopr</i>	20	80	%
Storage Humidity (Note)	<i>Hstg</i>	20	90	%
Vibration (10~55Hz)	—	—	4	G
Shock	—	—	40	G

Note) Avoid operations and/or Storage in moist environmental conditions.

2-4. Absolute Maximum Ratings

Table- 4

Item	Symbol	Min.	Max.	Unit
Supply Voltage	V _{CC}	-0.3	6.0	Vdc
Input signal Voltage	V _{IS}	-0.3	V _{CC} +0.3	Vdc

2-5. Recommended Operation Conditions

Table- 5

Item	Symbol	Min.	Typ.	Max	Unit
Supply Voltage	V _{CC}	4.75	5.0	5.25	Vdc
Input Signal Voltage SIN, SCK, /RESET	V _{IH}	0.8V _{CC}	—	V _{CC}	Vdc
	V _{IL}	0	—	0.2V _{CC}	

2-6. Electrical Optical Characteristics

Table- 6

Item	Symbol	Conditions	Min.	Typ.	Max.	Unit
Supply Current (Note1)	I _{CC}	V _{CC} =5.0V All dots on	—	200	260	mA
Power Consumption	—		—	1.0	1.3	W
Luminance (Note2)	L		250	500	—	cd/m ²
High-level output voltage	V _{OH}	V _{CC} =5.0V R _L =3kΩ to GND	3.8	—	V _{CC}	Vdc
Low-level output voltage	V _{OL}	V _{CC} =5.0V R _L =3kΩ to GND	0	—	0.6	Vdc

Note1) The surge current can be approx.5 times of specified maximum supply current at power on.

Note2) It indicates the value at 100% luminance adjustment level.

3. Interface

3-1. Communication

Communication between a host system and a module is carried out by Serial interface (It is selectable either CMOS synchronous or Asynchronous interface).

3-1-1. Basic function

There are two Serial interfaces: C-MOS Synchronous or Asynchronous and they are Selectable by jumper. After data is written in, SBUSY is set to '1' and SBUSY is set to '0' when a module is ready to receive next data.

3-1-2. Asynchronous serial interface timing

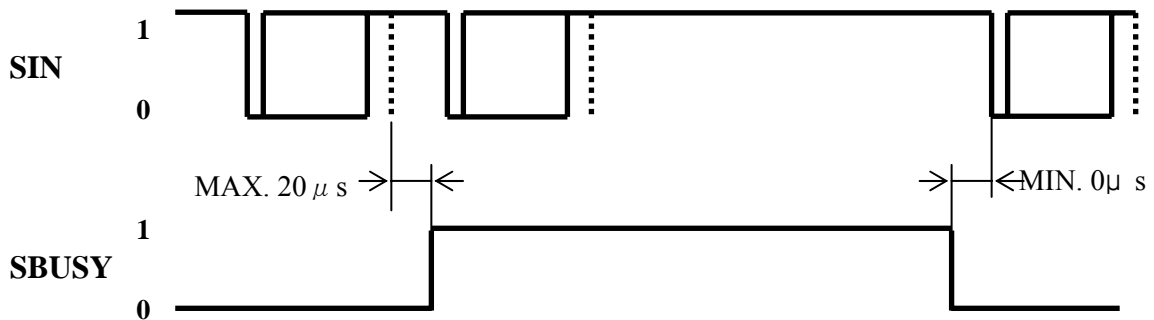

*Only 1 byte data can be receipt just after SBUSY=1

○Communication condition

Baud rate	9600~115200bps (Selectable by jumper)
Parity	Non parity
Format	Start (1bit) + data (8bit) + stop (1bit)
Handshake	SBUSY

3-1-3. Synchronous serial interface timing

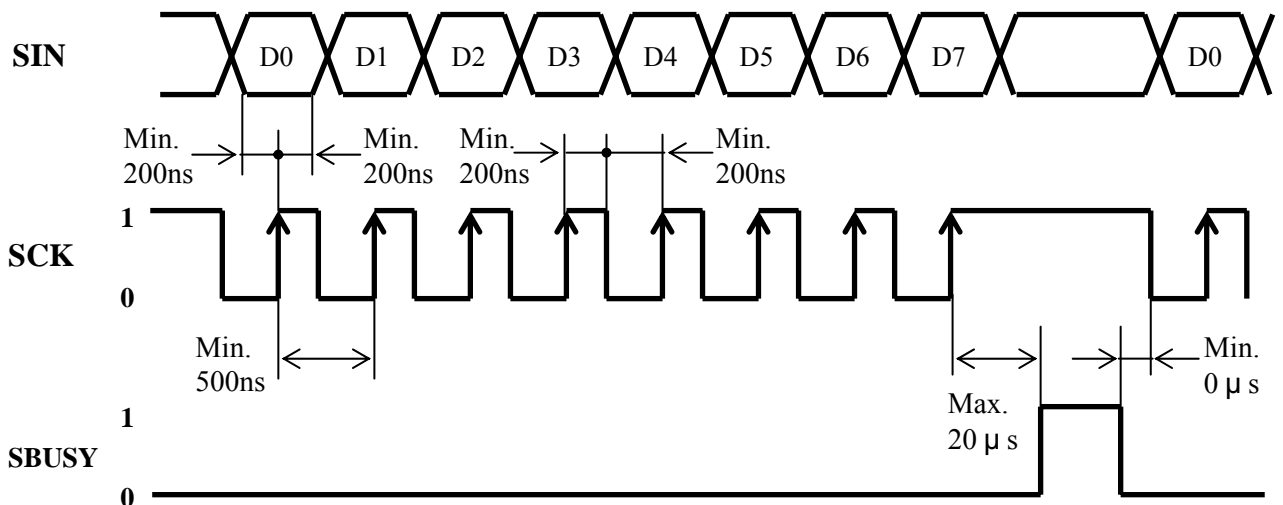

3-2. Reset timing

Reset pulse (active low) should be longer than 1ms.

After data is written in, SBUSY is set to '1' and SBUSY is set to '0' when a module is ready to receive next data.

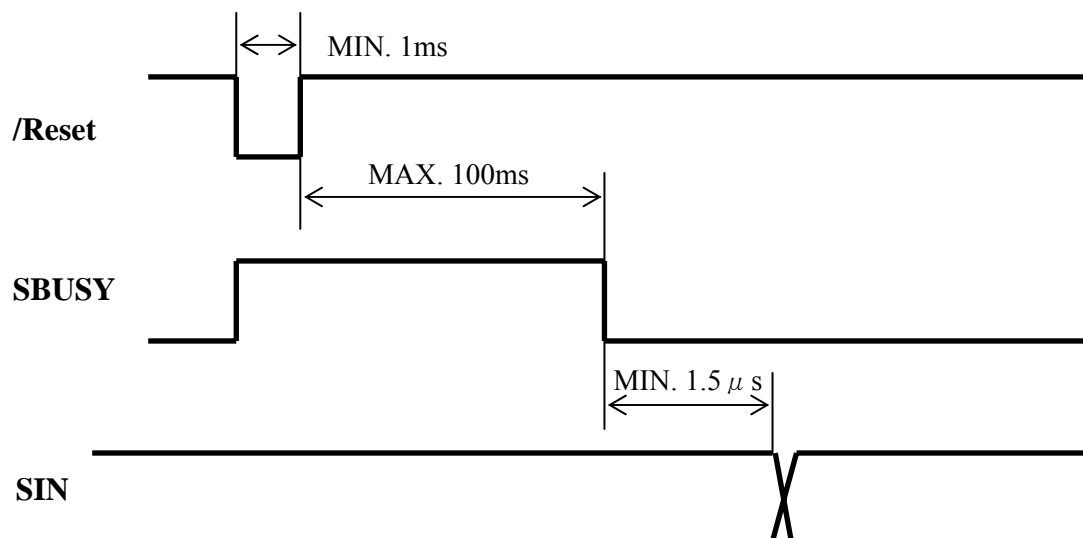

4. Display specification

4-1. Displayable image types

4-1-1. Graphic display

Number of dot : 112×16 dot

4-1-2. Character display

Character mode : 5×7 dot

Character font type : 5×7 dot-character, ANK, international font

Character display width: Fixed character 1 & 2, Proportional character format 1 & 2

Attribution: Character magnify, Reverse

4-2. Display memory

Size : 512×16 dot – separated as : Display area (112×16 dot)

Hidden area (400×16 dot)

Hidden area also can be displayed by using “Display action command group“

Refer to “Display action command group”, Page 18.

By using “User Window” function, All display area can be separated, and each window separated can be controlled independently.

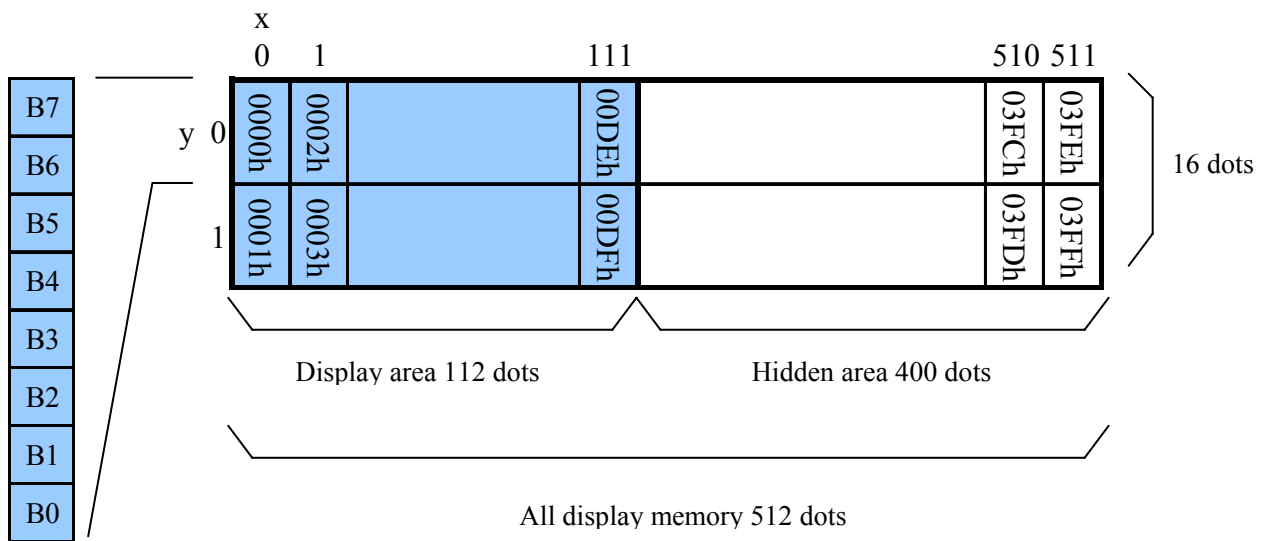

4-3. Window

Window function divides display screen as “Window”, and each divided “Window can be controlled and displayed independently. Refer to “Window command group”, Page 22.

There is no independent display memory for each “Window”.

There are 2 types of “Window”, Base-Window and User-Window.

4-3-1. Base-Window

This has the whole display screen and if User-Window is not defined, all display operation is processed under this Base-Window.

When some User-Window is defined, the display operation to the cut of display screen of User-Window should be processed under Base-Window.

When Base-Window is selected even if some User-Window is defined, all of display operation is processed under Base-Window. Therefore, the current display pattern of User-Window is overwritten.

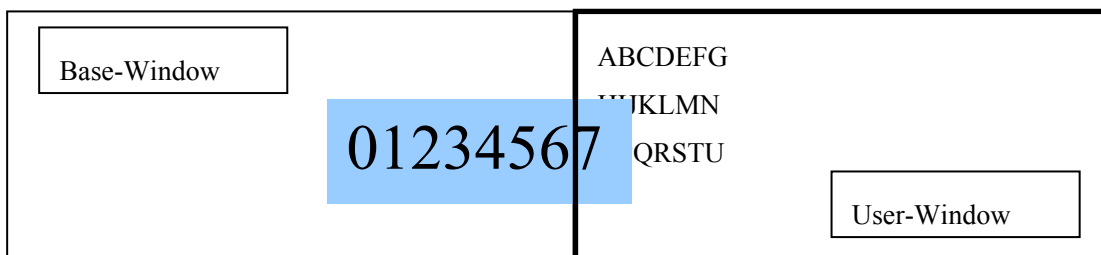

4-3-2. User-Window

User-Window is defined by command, and display operation can be processed on User-Window selected by “Current Window select” command.

User-Window can be defined up to 4 windows.

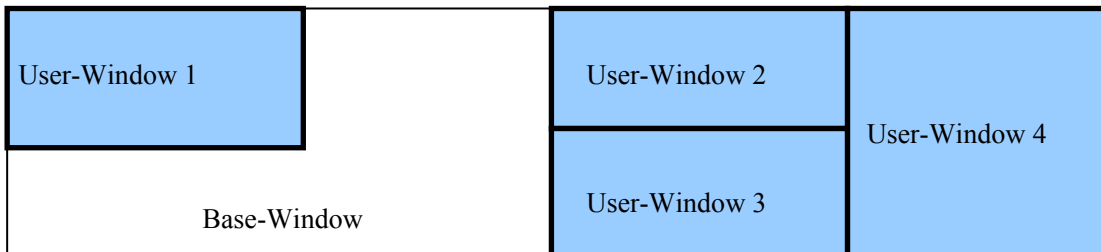

4-4. Write screen mode for “Base-Window”

This effects only for Base-Window.

There are two types of Write screen mode, Display screen mode and All screen mode which can be changed by command. (Refer to Window command group, “Write screen mode select”, Page 24)

4-4-1. Display screen mode (Scanning)

When the cursor is located on the Display area, all of operation will be done within Display area, and when cursor is located on the Hidden area, it will be done within Hidden area.

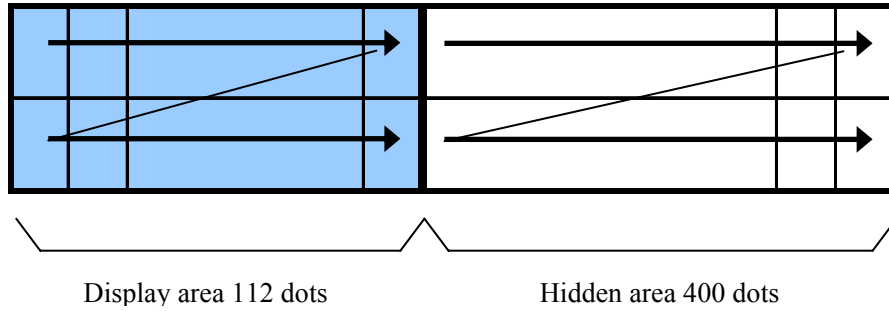

4-4-2. All screen mode (Scanning)

All of operation will be done on all of area.

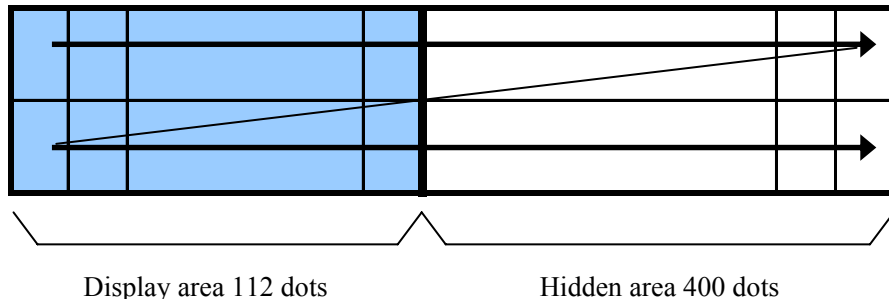

4-5. Character display format

Character display format is following selectable by “Character display width” command.

- In case of proportional character width is specified, the blank character (20H) will be operated as same as 2 dot width character

Type of character	Display position	Format	Fixed character width 1	Fixed character width 2	Proportional character width 1	Proportional character width 2
Standard character and Download character 5×7dot	Y=0 (Top line)	Character size	5×7	5×7	n×7	n×7
		Upper space	0	0	0	0
		Lower space	1	1	1	1
		Left space	0	1	0	1
		Right space	1	1	1	1
	Y=1 (Bottom line)	Character size	5×7	5×7	n×7	n×7
		Upper space	1	1	1	1
		Lower space	0	0	0	0
		Left space	0	1	0	1
		Right space	1	1	1	1
Download Character 7×8 dot	Y=0 (Top line)	Character size	6×8 *	7×8	6×8 *	6×8
		Upper space	0	0	0	0
	Y=1 (Bottom line)	Lower space	0	0	0	0
		Left space	0	0	0	0
		Right space	0	0	0	0

*The most left part of 6×8 dot within 7×8 dot is displayed.

[Fixed character width 1]

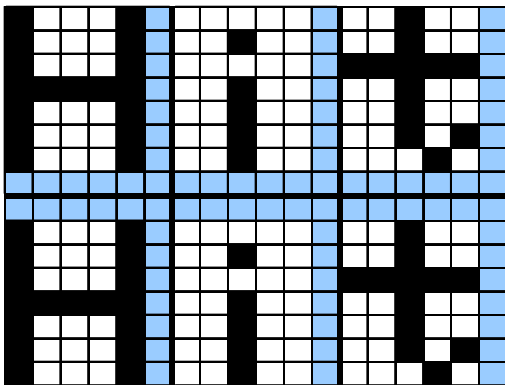

[Fixed character width 2]

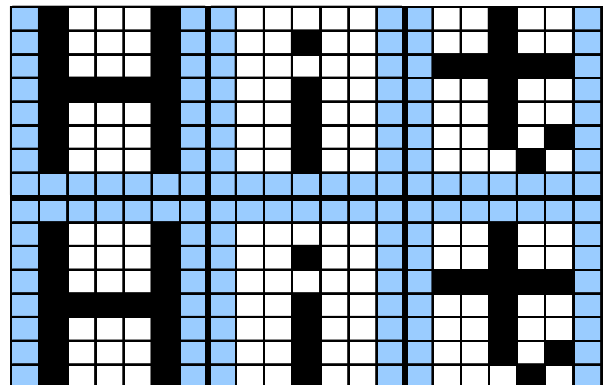

[Proportional character width 1]

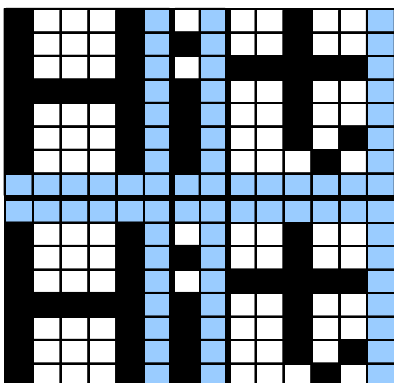

[Proportional character width 2]

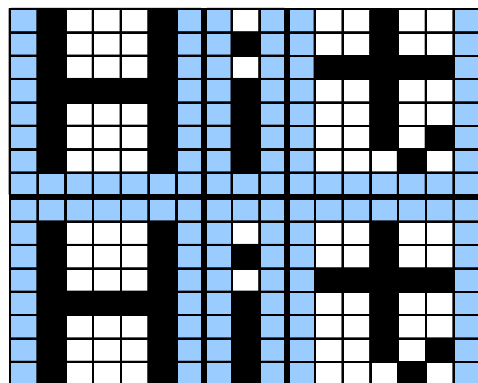

5. Function

5-1. Commands

The details of each command as follows;

The size of character ($X \times Y$ dot) described in this section is depending on the command of “Character display width” or “Font magnified display”.

Number of X dot and Y dot for 1 character width for each commands except “Character display” under the condition of each character display width are as follows;

Character type	Fixed character width 1	Fixed character width 2	Proportional character width 1	Proportional character width 2
Number of X dot	5+1	5+2	5+1	5+2
Number of Y dot	7+1	7+1	7+1	7+1

5-1-1. Character display

Name: Character display

Code:20h — FFh

Function: Display the character on cursor position.

This command effects on the current window selected by “Current window select”

When MD1 mode is selected.

Cursor position		Operation
	Y direction	
The space for 1 character size is in right side.	—	Display >> HT
Right end	The space for one line is in the lower side.	HT >> Display >> HT
	The space for one line is NOT in the lower side.	HT >> Display >> HT

When MD2 mode is selected.

Cursor position		Operation
X direction	Y direction	
The space for 1 character size is in right side.	—	Display >> HT
Right end	The space for one line is in the lower side.	HT >> Display >> HT
	The space for one line is NOT in the lower side.	HT >> Display >> HT

When MD3 mode is selected.

Cursor position		Operation
X direction	Y direction	
The space for 1 character size is in right side.	—	Display >> HT
Right end	—	HT >> Display >> HT

5-1-2. BS

Name: Back Space

Code:08h

Function: The cursor moves to left by one character.

This command effects on the current window selected by “Current window select”.

When MD1 and MD2 modes is selected.

Cursor position		Operation
X direction	Y direction	
The space for 1 character size is in right side.	—	The cursor moves to left by one character.
Right end	The space for one line is in the lower side.	The cursor moves to the right end of one upper line.
	The space for one line is NOT in the lower side.	The cursor does not move.

When MD3 mode is selected.

Cursor position		Operation
X direction	Y direction	
The space for 1 character size is in right side.	—	The cursor moves to left by one character.
Right end	—	The cursor does not move.

5-1-3. HT

Name: Horizontal Tab

Code:09h

Function: The cursor moves to right by one character.

This command effects on the current window selected by “Current window select”.

When MD1 mode is selected.

Cursor position		Operation
X direction	Y direction	
The space for 1 character size is in right side.	—	The cursor moves to right by one character.
Right end	The space for one line is in the lower side.	The cursor moves to the left end of one lower line.
	The space for one line is NOT in the lower side.	The cursor moves to the left end of top line.

When MD2 mode is selected.

Cursor position		Operation
X direction	Y direction	
The space for 1 character size is in right side.	—	The cursor moves to right by one character.
Right end	The space for one line is in the lower side.	The cursor moves to the left end of one lower line.
	The space for one line is NOT in the lower side.	All displayed pattern is scrolled up to one upper line, displayed pattern of lowest line is cleared. And cursor moves to left end of bottom line.

When MD3 mode is selected.

Cursor position		Operation
X direction	Y direction	
The space for 1 character size is in right side.	—	The cursor moves to right by one character.
Right end	—	The displayed pattern on cursor line is scrolled to left by one character, Right end character is cleared, and cursor moves to the right end.

5-1-4. LF

Name: Line Feed

Code:0Ah

Function: The cursor moves to one lower line.

This command effects on the current window selected by “Current window select”.

When MD1 mode is selected.

Cursor position		Operation
X direction	Y direction	
—	The space for one line is in the lower side.	The cursor moves to the same position of one lower line.
	The space for one line is NOT in the lower side.	The cursor moves to the left end top line.

When MD2 mode is selected.

Cursor position		Operation
X direction	Y direction	
—	The space for one line is in the lower side.	The cursor moves to the same position of one lower line.
	The space for one line is NOT in the lower side.	All of displayed pattern is scrolled to one upper line, and displayed pattern of bottom line is cleared. The cursor does not move.

When MD3 mode is selected.

Cursor position		Operation
X direction	Y direction	
—	—	The cursor does not move.

5-1-5. HOM

Name: Home Position

Code:0Bh

Function: The cursor moves to the home position.

This command effects on the current window selected by “Current window select”.

5-1-6. CR

Name: Carriage Return

Code:0Dh

Function: The cursor moves to the left end of same line.

This command effects on the current window selected by “Current window select”.

5-1-7. US \$ xL xH yL yH

Name: Cursor Set

Code: 1Fh 24h xL xH yL yH

xL: Cursor position x Lower byte (1 dot/unit)

xH: Cursor position x Upper byte (1 dot/unit)

yL: Cursor position y Lower byte (8 dot/unit)

yH: Cursor position y Upper byte (8 dot/unit)

Definable area: $0 \leq (xL+xH \times 256) \leq 511$

$0 \leq (yL+yH \times 256) \leq 1$

Function: The cursor moves to specified X, Y position on display memory.

If the specified X, Y position (X, Y, either or both) is over range, the command is ignored, and keep same cursor position.

This command effects on the current window selected by "Current window select".

5-1-8. CLR

Name: Display Clear

Code: 0Ch

Function: The display screen is cleared and the cursor moves to home position after this command was executed.

This command effects on the current window selected by "Current window select".

5-1-9. ESC @

Name: Initialize Display

Code: 1Bh 40h

Function: Return to default.

The contents of receiving buffer remain in memory.

Jumper set is not re-loaded.

5-1-10. ESC % n

Name: Specify Download Register

Code: 1Bh 25h n

Definable area: n=0, 1

Default: n=0

Function: Specify enable or disable for download character.

- n=1: Enable (If download character is not defined, built-in character is displayed)
- n=0: Disable (Characters already downloaded, defined, and displayed are not affected)

5-1-11. ESC& a c1 c2 [x1 d1...d(a×x1)]...[xk d1...d(a×xk)]

Name: Download character definition

Code:1Bh 26h a c1 c2 [x1 d1...d(a×x1)]...[xk d1...d(a×xk)]

- a: Select character type
- c1: Start character code
- c2: End character code
- x: Number of dot for X direction
- d: Defined data

Definable area: a=1

x=5: 5×7 dot font

x=7: 7×8 dot font

$32 \leq c1 \leq c2 \leq 255$

$0 \leq d \leq 255$

x=5: Upper 7 bit is valid

x=7: All 8 bit is valid

$k=c2-c1+1$

Function: To define download characters into RAM.

A maximum of 16 characters may be downloaded and defined.

x=5: Defined by 5×7 dot, and 5×7 dot character regulated upper and lower space is displayed as same as standard character display.

x=7: Defined by 7×8 dot and 6×8 or 7×8 dot character unrelated to space is displayed.

After the first 16 are defined, any additional characters required must replace one already defined.

Downloaded characters are valid until they redefined, an initialize (ESC@) sequence is executed, or the power is turn off.

To display the download character, execution of "Download character definition" and "Specify download character" is required.

In case of displaying download character is re-defined, displaying character is not changed, new download character is applied from new data.

[5×7dot]

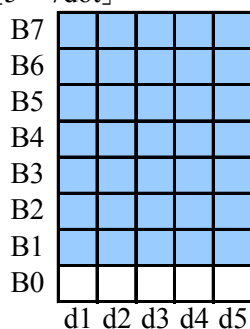

[7×8dot]

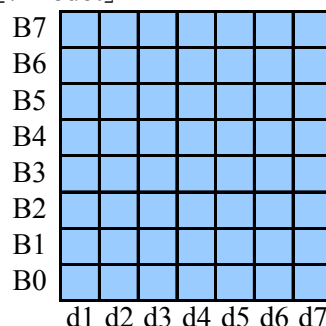

5-1-12. ESC ? a c

Name: Delete download character

Code:1Bh 3Fh a c

- a: Select character
- c: Character code for delete

Definable area: a=1

$32 \leq c \leq 255$

Function: Delete defined download character.

The built-in character is displayed after this command is executed.

It does not affect to the displaying download character.

This command is ignored if character code for download character is not defined.

5-1-13. ESC R n

Name: Specifies International font set

Code: 1Bh 52h n

Definable area: $0 \leq n \leq 13$

Default: n=0

Function: Select international font set.

n	Font set
0	America
1	France
2	Germany
3	England
4	Denmark 1
5	Sweden
6	Italy
7	Spain 1
8	Japan
9	Norway
10	Denmark 2
11	Spain 2
12	Latin America
13	Korea

5-1-14. ESC t n

Name: Specifies character code type

Code: 1Bh 74h n

Definable area: n=0, 1, 2, 3, 4, 5, 16, 17, 18, 19

Default: n=0

Function: Select international font set.

n	Font code type
0	PC437 (USA: Standard Europe)
1	Katakana - Japanese
2	PC850 (Multilingual)
3	PC860 (Portuguese)
4	PC863 (Canadian-French)
5	PC865 (Nordic)
16	WPC1252
17	PC866 (Cyrillic #2)
18	PC852 (Latin 2)
19	PC858

5-1-15. US MD1

Name: Over-write mode

Code:1Fh 01h

Function: Over-writes, or replaces existing data.

This command effects on the current window selected by “Current window select”.

5-1-16. US MD2

Name: Vertical scroll mode

Code:1Fh 02h

Function: Scrolls cursor up 1 line.

This command effects on the current window selected by “Current window select”.

Note: If graphic image and character display is shown together on the same window, and specify this mode on that window, it may cause irregular graphic image. Please do not apply this command to the window showing such mixture display.

5-1-17. US MD3

Name: Horizontal scroll mode

Code:1Fh 03h

Function: Scroll cursor horizontally 1 space.

This command effects on the current window selected by “Current window select”.

5-1-18. US s n

Name: Horizontal scroll speed

Code:1Fh 73h n

Definable area:0 ≤ n ≤ 31

Default: n=0

Function: If n=0 is specified, scrolling is appeared by character n

n	Speed
0	By Character
1	T msec/ 2 dots
2~31	(n-1) × T msec / dot

Note: New command(s) will not executed until scrolling action is ended.

Scroll base speed “T” is depending on write screen mode, character size selected.

5-1-19. Us r n

Name: Specifies or cancels reverse display

Code:1Fh 72h n

n: Specify or cancel reverse character and graphic display

Definable area:0 ≤ n ≤ 1

n=0:Cancel reverse mode

n=1:Specify reverse mode

Default: n=0

Note: This command is valid to new data after this command is specified.

This does not affect the contents already display.

5-1-20. US w n

Name: Specifies write mixture display mode

Code:1Fh 77h n

n: Specify display mode

Definable area:0 ≤ n ≤ 3

n=0:Normal display write (Not mixture display)

n=1:OR display write

n=2:AND display write

n=3:EX-OR display write

Default: n=0

Function: Specifies write mixture mode.

The new character or graphic image display mixed with current display image stored in display memory is overwritten to the display memory.

5-1-21. US X n

Name: Brightness level setting

Code:1Fh 58h n

n: level

Definable area:1 ≤ n ≤ 8

Default: n=8

Function: Specify brightness level of display screen

N	Level
1	12.5%
2	25.0%
3	37.5%
4	50.0%
5	62.5%
6	75.0%
7	87.5%
8	100%

5-1-22. US (a n [parameter])

Name: Display action command group

Function: Execute processing of display action command.

n	Function No.	Function
01h	Function 01h	Wait
10h	Function 10h	Scroll display action
11h	Function 11h	Blink display action
40h	Function 40h	Screen saver

n: specify function code.

The next command or data is not executed until display action processing is ended.

5-1-23. <Function 01h> US (a n t

Name: Wait

Code:1Fh 28h 61h 01h t

n: Classify command

t: Wait time

Definable area: n=01h

$$0 \leq t \leq 255$$

Function: Wait time, define, command and data processing are stopped while waiting by this command

$$\text{Wait time} = t \times \text{approx.}0.5 \text{ sec}$$

5-1-24. <Function 10h> US (a n wL wH cL cH s

Name: Scroll display action

Code:1Fh 28h 61h 10h wL wH cL cH s

n: Classify command

wL: Display screen shift, number of lower byte

wH: Display screen shift number of upper byte

cL: Number of repetition lower byte

cH: Number of repetition upper byte

s: Scroll action speed

Definable area: n=10h

$$0 \leq (wL + wH \times 256) \leq 1023$$

$$1 \leq (cL + cH \times 256) \leq 65535$$

$$0 \leq s \leq 255$$

Function: Shift the display screen

Horizontal scrolling can be possible by specifying the shift byte to multiple number of (Display screen "y" dot/8). Display switching can be possible by specify shift byte to (Display screen "x" dot × Display screen "y" dot/8). Scroll speed is specified by "s".
 Scroll speed :s × approx.14msec/1 shift.

For example: 1dot scroll to the left: wL=02h, wH=00h

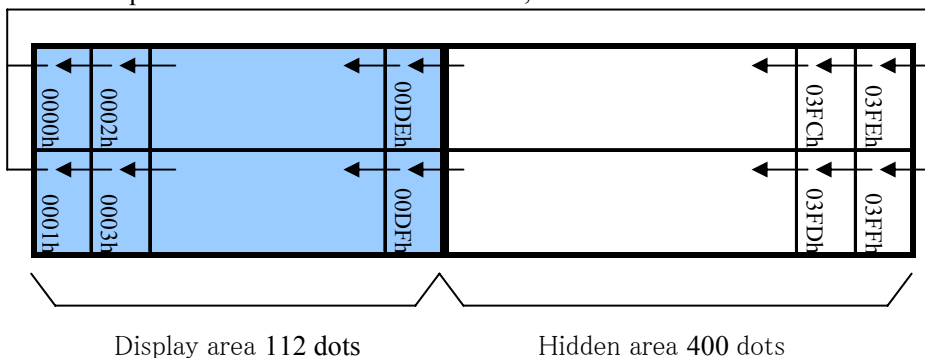

5-1-25. <Function 11h> US (a n p t1 t2 c

Name: Display Blink

Code:1Fh 28h 61h 11h p t1 t2 c

n: Classify command

p: Blink pattern

t1: Normal display

t2: Blank or Reverse display time

c: Number of repetition

Definable area: n=11h

$0 \leq p \leq 2$

p=0:Normal display

p=1:Repeat blink display with normal and Blank display

p=2:Repeat blink display with normal and Reverse display

$1 \leq t1 \leq 255$

$1 \leq t2 \leq 255$

$0 \leq c \leq 255$

Function: Blink display action.

Blink pattern specified by “p”.

Time specified by “t1”, “t2”, and repeat Blink display.

A:t1 × approx.14msec Normal display

B:t2 × approx.14msec Blank or Reverse display

This command does not affect to display memory

If c=0 is specified, blink display is repeated until when c=1-255 or initialize command is specified, and the command/data execution is continued during display blinking.

If c=1-255 is specified, blink display is repeated 1-255 times, and the command/data execution is stopped.

After display blinking is ended, return to normal display and command/data execution is re-started.

5-1-26. <Function 40h> US (a n p

Name: Screen saver

Code:1Fh 28h 61h 40h p

n: Classify command

p: Screen saver mode

Definable area: n=40h

$0 \leq p \leq 4$

p=0:Power OFF (All dot OFF, Power save mode)

p=1:Power ON (All dot ON)

p=2:All dot OFF

p=3:All dot ON

p=4:Repeat blink display with normal and Reverse display(Normal:2sec, Reverse:2sec)

Function: Control Power ON or OFF, and Start Screen saver mode.

p=0~1:Control Power ON or OFF. This is applied until this command is re-specified.

p=2~4:Start Screen saver mode. This command is canceled if next any data is inputted during screen saver mode, and return to the previous display condition before screen saver mode specified.

5-1-27. US (f n [parameter])

Name: Bit image display group

Function: Execute processing of bit image data.

N	Function No.	Function
11h	Function 11h	Real-time bit image display

n: Specifies function code.

5-1-28. <Function 11h> US (f n xL xH yL yH g d(1)...d(k))

Name: Real-time bit image display

Code: 1Fh 28h 66h 11h xL xH yL yH g d(1)...d(k)

n: Classify command

xL: Bit image X size lower byte (by 1dot)

xH: Bit image X size upper byte (by 1dot)

yL: Bit image Y size lower byte (by 8dots)

yH: Bit image Y size upper byte (by 8dots)

g: Image=1 (Fixed)

d(1)–d(k): Image data (Refer to figure as follows)

Definable area: n=11h

$$1 \leq (xL+xH \times 256) \leq 512$$

$$1 \leq (yL+yH \times 256) \leq 2$$

$$g=1$$

$$0 \leq d \leq 255$$

$$k=x \times y \times g$$

Function: Display the bit image data inputted on the cursor position real-time

Cursor position will not change

When bit image is display on cursor position, and if it overflows from the window, it is displayed until edge of area defined, and remaining bit image overflowed is not displayed.

If the Display position or image sizes etc. are defined to out of definable area, the command is ignore, and data is valid as standard data.

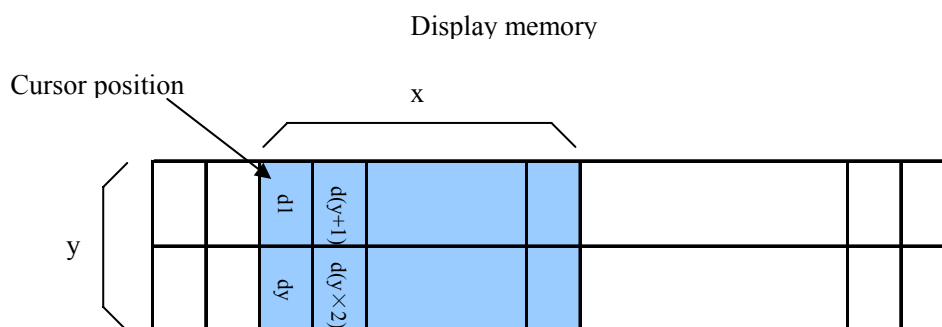

5-1-29. US (g n [parameter]

Name: Font command group

Function: Execute processing of window command.

N	Function No.	Function
03h	Function 03h	Character display width
40h	Function 40h	Font magnified display

n: specify function code.

5-1-30. <Function 03h> US (g n w

Name: Character display width

Code:1Fh 28h 67h 03h w

n: Classify command

w: Specify width

Definable area: n=03h

$$0 \leq w \leq 3$$

w=0:Fixed character width 1 (1dot space in right side)

w=1:Fixed character width 2 (1dot space in each right and left side)

w=2:Proportional character width 1 (1dot space in right side)

w=3:Proportional character width 2 (1dot space in each right and left side)

Default: w=1

Function: Specifies character display width.

Fixed character width 1&2: Character is written with fixed character width. (6 or 7dot)

Proportional character width: Character is written with proportioned character width.

5-1-31. <Function 40h> US (g n x y

Name: Font magnified display

Code:1Fh 28h 67h 40h x y

n: Classify command

x: Specify the size of magnification X

y: Specify the size of magnification Y

Definable area: n=40h

$$1 \leq x \leq 4$$

$$1 \leq y \leq 2$$

Default: x=1

y=1

Function: Specifies magnification of character.

Character is magnified including the space specified by Character display width command.

[x=1, y=1]

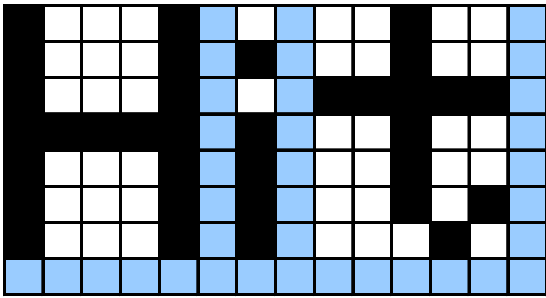

[x=2, y=2]

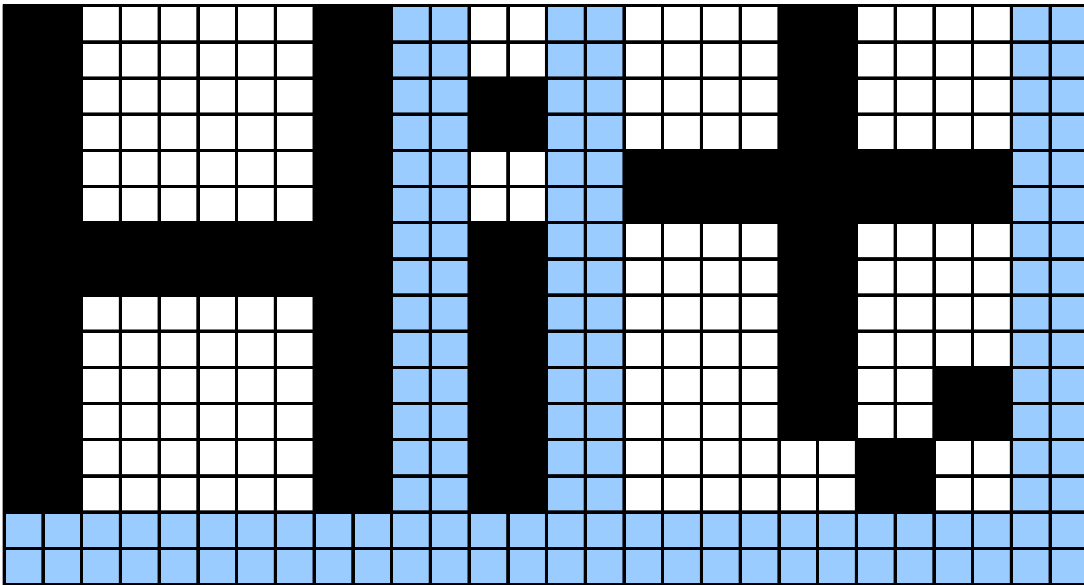

5-1-32. US (w n [parameter])

Name: Window command group

Function: Execute processing of window / screen command.

N	Function No.	Function
01h	Function 01h	Current window select
02h	Function 02h	User-Window definition and cancel
10h	Function 10h	Write screen mode select

n: specify function code.

5-1-33. <Function 01h> US (w n a

Name: Current Window select)

Code:1Fh 28h 77h 01h a

n: Classify command

a: Current window number.

a=0: Base-Window

a=1~4: User-Window

Definable area: n=01h

$0 \leq a \leq 4$

Function: Select current window

This command is ignored if current window number is specified for User-Window that is not defined.

5-1-34. <Function 02h> US (w n a b) [xPL xPH yPL yPH xSL xSH ySL ySH]

Name: User Window definition-cancel

Code:1Fh 28h 77h n a b [xPL xPH yPL yPH xSL xSH ySL ySH]

n: Classify command

a: Definable window No. : No.1~4

b: Definable or Cancel

b=0:Cancel, b=1:Define

xPL: Left position of window lower byte (by 1dot)

xPH: Left position of window upper byte (by 1dot)

yPL: Top position of window lower byte (by 8dots)

yPH: Top position of window upper byte (by 8dots)

xSL: X size of window lower byte (by 1dot)

xSH: X size of window upper byte (by 1dot)

ySL: Y size of window lower byte (by 8dots)

ySH: Y size of window upper byte (by 8dots)

Definable area: n=02h

$$1 \leq a \leq 4$$

$$0 \leq b \leq 1$$

$$0 \leq xP \leq 511$$

$$0 \leq yP \leq 1$$

$$1 \leq xS \leq 512$$

$$1 \leq yS \leq 2$$

Function: Define or cancel User-Window

Display contents are remained even if this command is executed.

When User-Window is defined (b=1)

Specify Definable Window No., Window position and Window size, and Window position and Window size are specified by the block (Block/1×8dot)

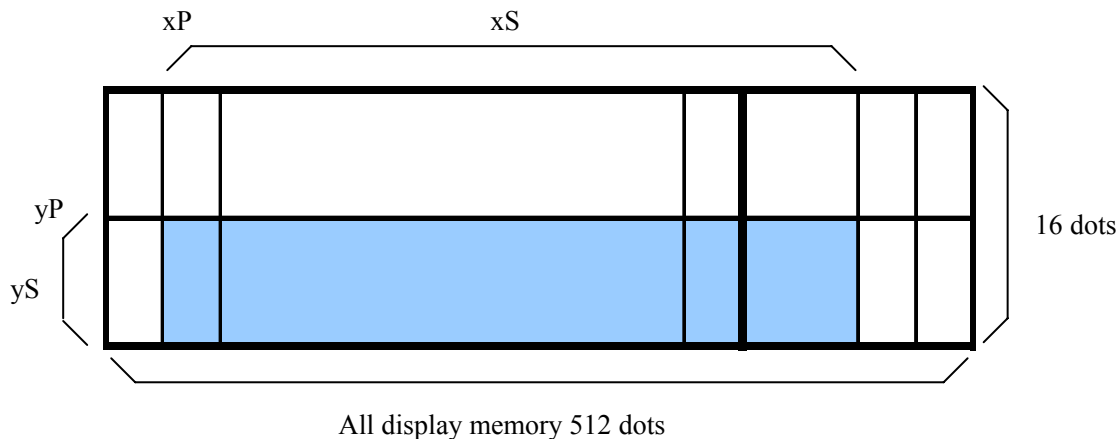

User-Window can be defined up to 4 windows.

The cursor position after executed this command is specified to top left (X=0, Y=0).

When User-Window is canceled (b=0)

It is not necessary to specify window position [xPL~ySH] in case of cancel the User-Window.

The Base-Window is selected as current window in case of user window canceled was selected as current window.

5-1-35. <Function 10h> US (w n a

Name: Write screen mode select

Code:1Fh 28h 77h n a

n: Classify command

a: Write screen mode

a=0:Display screen mode

a=1:All screen mode

Definable area: n=10h

$0 \leq a \leq 1$

Default: a=0

Function: Select the write screen mode. This effects only for Base Window.

Display action is valid within area of either Display area or Hidden area depending on cursor position.

Select "All screen mode". Display action is valid on all of screen area.

6. Setup

6-1.Jumper

No.	Function	Default
J0	Baud rate	OPEN
J1		OPEN
J2	Select serial I/F	OPEN
J3	Reserve	OPEN

6-1-1. Baud rate select (Applying for Asynchronous serial interface)

J0	J1	Baud rate
OPEN	OPEN	38400bps
SHORT	OPEN	19200bps
OPEN	SHORT	9600bps
SHORT	SHORT	115200bps

6-1-2. Serial interface select

J2	Mode
OPEN	Asynchronous serial I/F
SHORT	Synchronous serial I/F

7. Connector-CN1

7-1. Case of Asynchronous serial interface is selected.

Pin No.	Signal name	Function	Direction
1	Vcc	Power supply	Input
2	SIN	Data receive	Input
3	GND	Ground	Input
4	SBUSY	Display busy	Output
5	NC	No connect	—
6	/RESET	Reset	Input

7-2. Case of Synchronous serial interface is selected.

Pin No.	Signal name	Function	Direction
1	Vcc	Power supply	Input
2	SIN	Data receive	Input
3	GND	Ground	Input
4	SBUSY	Display busy	Output
5	SCK	Display clock	Input
6	/RESET	Reset	Input

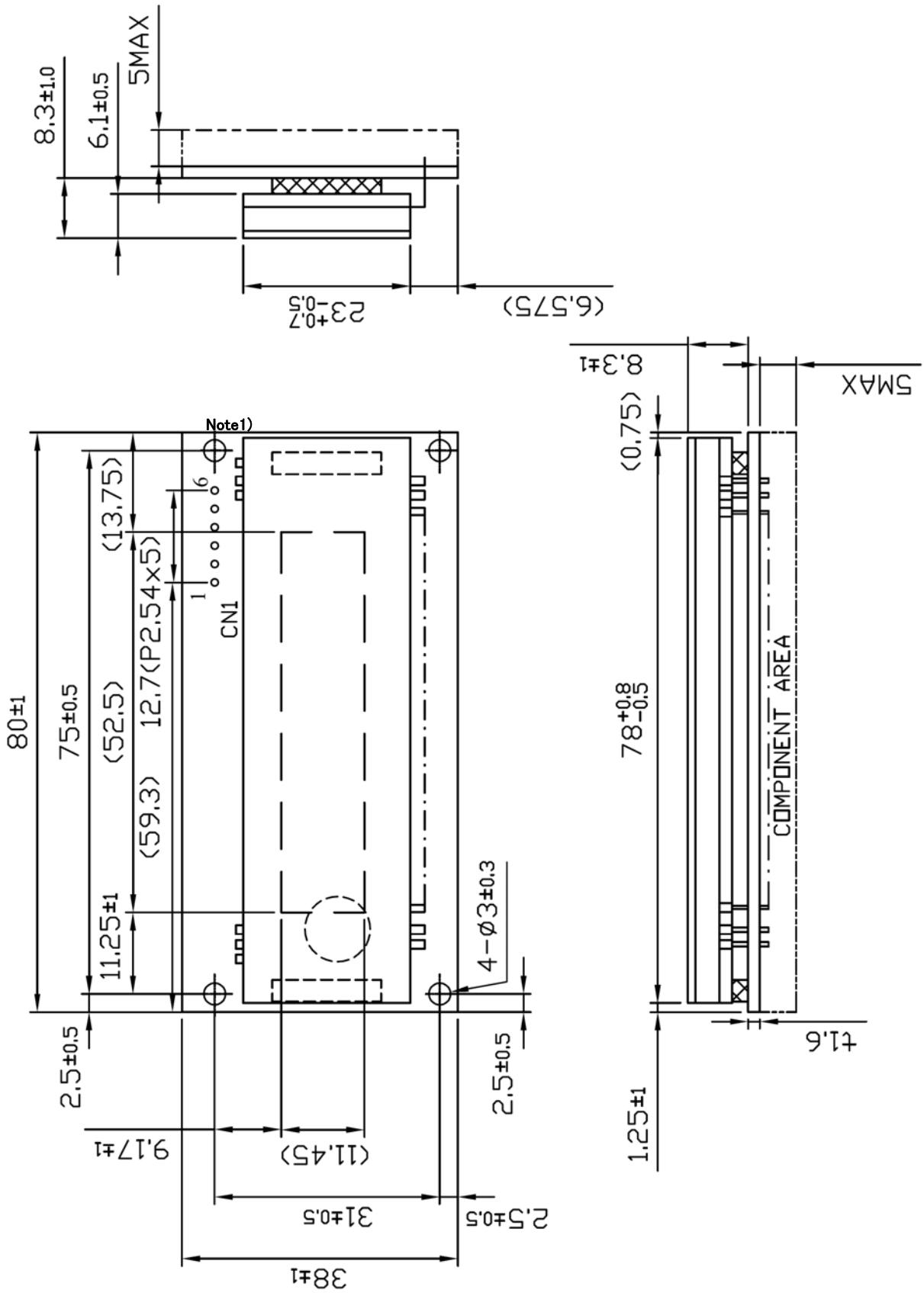

Note1) Please attentions don't touch the VFD Lead with Connector (CN1)

The connector is inserted from the VFD side, and soldered with the component side.

The customer selects the connector.

BLOCK DIAGRAM

FIGURE-2

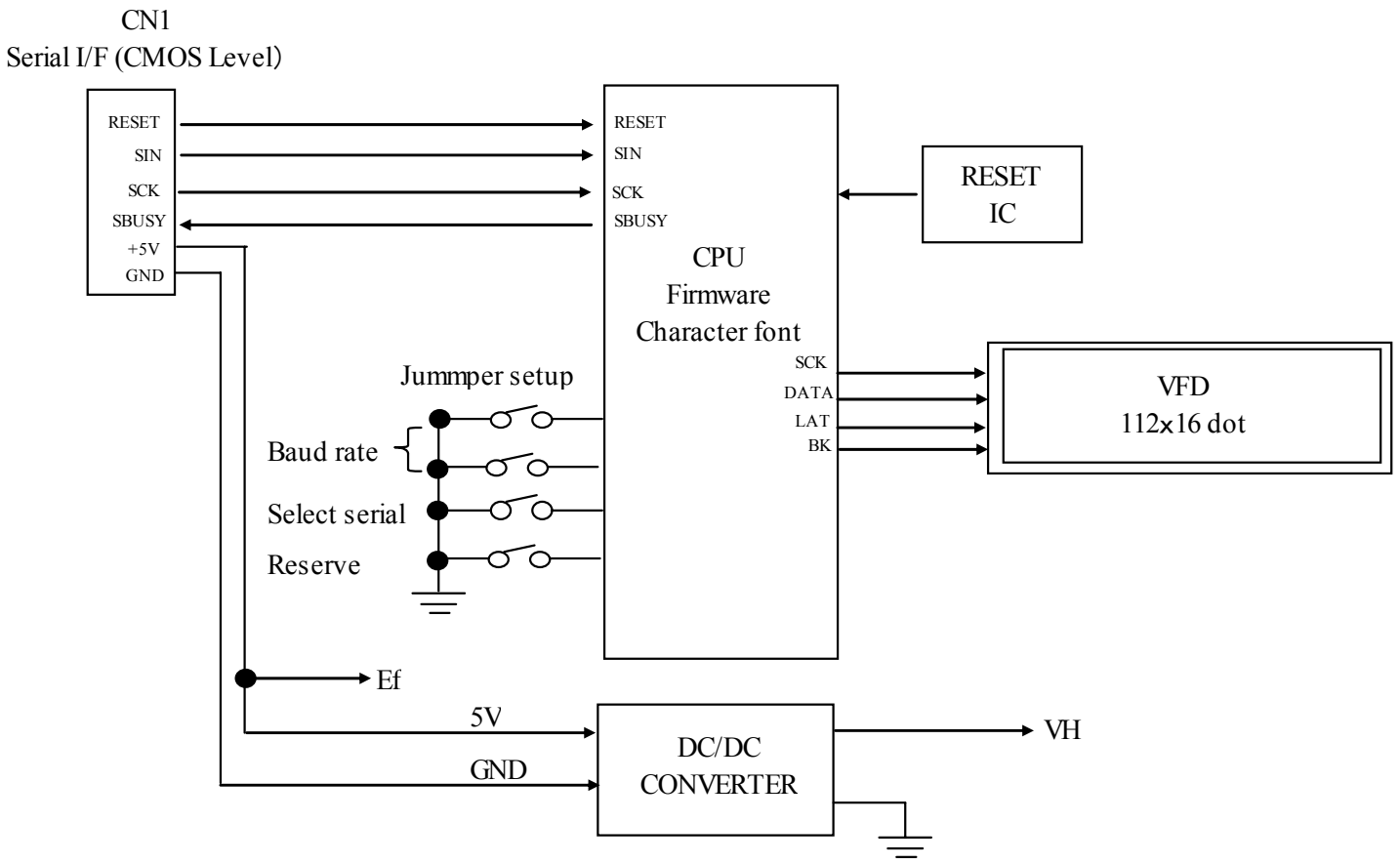

7-3. FONT TABLE

1. Common Font Set (20H-7FH)

	+0	+1	+2	+3	+4	+5	+6	+7	+8	+9	+A	+B	+C	+D	+E	+F
20	□	!	"	#	\$	%	&	'	()	*	+	,	-	.	/
30	0	1	2	3	4	5	6	7	8	9	:	;	<	=	>	?@
40	A	B	C	D	E	F	G	H	I	J	K	L	M	N	O	
50	P	Q	R	S	T	U	V	W	X	Y	Z	[\]	^	_
60	`	a	b	c	d	e	f	g	h	i	j	k	l	m	n	o
70	p	q	r	s	t	u	v	w	x	y	z	{		}	~	□

2. International Font Set

International Font Set is selected by ESC R n command.

	23H	24H	40H	5BH	5CH	5DH	5EH	60H	7BH	7CH	7DH	7EH
n=00H	#	\$	%	&	'	()	*	+	,	-	.
n=01H	#	\$	%	&	'	()	*	+	,	-	.
n=02H	#	\$	%	&	'	()	*	+	,	-	.
n=03H	#	\$	%	&	'	()	*	+	,	-	.
n=04H	#	\$	%	&	'	()	*	+	,	-	.
n=05H	#	\$	%	&	'	()	*	+	,	-	.
n=06H	#	\$	%	&	'	()	*	+	,	-	.
n=07H	#	\$	%	&	'	()	*	+	,	-	.
n=08H	#	\$	%	&	'	()	*	+	,	-	.
n=09H	#	\$	%	&	'	()	*	+	,	-	.
n=0AH	#	\$	%	&	'	()	*	+	,	-	.
n=0BH	#	\$	%	&	'	()	*	+	,	-	.
n=0CH	#	\$	%	&	'	()	*	+	,	-	.
n=0DH	#	\$	%	&	'	()	*	+	,	-	.

3.Character Code Type (80H-FFH)

Character Code Type is selected by ESC t n command.

n=0

	+0	+1	+2	+3	+4	+5	+6	+7	+8	+9	+A	+B	+C	+D	+E	+F
80	☐	☐	☐	☐	☐	☐	☐	☐	☐	☐	☐	☐	☐	☐	☐	☐
90	☐	☐	☐	☐	☐	☐	☐	☐	☐	☐	☐	☐	☐	☐	☐	☐
A0	☐	☐	☐	☐	☐	☐	☐	☐	☐	☐	☐	☐	☐	☐	☐	☐
B0	☐	☐	☐	☐	☐	☐	☐	☐	☐	☐	☐	☐	☐	☐	☐	☐
C0	☐	☐	☐	☐	☐	☐	☐	☐	☐	☐	☐	☐	☐	☐	☐	☐
D0	☐	☐	☐	☐	☐	☐	☐	☐	☐	☐	☐	☐	☐	☐	☐	☐
E0	☐	☐	☐	☐	☐	☐	☐	☐	☐	☐	☐	☐	☐	☐	☐	☐
F0	☐	☐	☐	☐	☐	☐	☐	☐	☐	☐	☐	☐	☐	☐	☐	☐

n=1

	+0	+1	+2	+3	+4	+5	+6	+7	+8	+9	+A	+B	+C	+D	+E	+F
80	☐	☐	☐	☐	☐	☐	☐	☐	☐	☐	☐	☐	☐	☐	☐	☐
90	☐	☐	☐	☐	☐	☐	☐	☐	☐	☐	☐	☐	☐	☐	☐	☐
A0	☐	☐	☐	☐	☐	☐	☐	☐	☐	☐	☐	☐	☐	☐	☐	☐
B0	☐	☐	☐	☐	☐	☐	☐	☐	☐	☐	☐	☐	☐	☐	☐	☐
C0	☐	☐	☐	☐	☐	☐	☐	☐	☐	☐	☐	☐	☐	☐	☐	☐
D0	☐	☐	☐	☐	☐	☐	☐	☐	☐	☐	☐	☐	☐	☐	☐	☐
E0	☐	☐	☐	☐	☐	☐	☐	☐	☐	☐	☐	☐	☐	☐	☐	☐
F0	☐	☐	☐	☐	☐	☐	☐	☐	☐	☐	☐	☐	☐	☐	☐	☐

n=2

	+0	+1	+2	+3	+4	+5	+6	+7	+8	+9	+A	+B	+C	+D	+E	+F
80	☐	☐	☐	☐	☐	☐	☐	☐	☐	☐	☐	☐	☐	☐	☐	☐
90	☐	☐	☐	☐	☐	☐	☐	☐	☐	☐	☐	☐	☐	☐	☐	☐
A0	☐	☐	☐	☐	☐	☐	☐	☐	☐	☐	☐	☐	☐	☐	☐	☐
B0	☐	☐	☐	☐	☐	☐	☐	☐	☐	☐	☐	☐	☐	☐	☐	☐
C0	☐	☐	☐	☐	☐	☐	☐	☐	☐	☐	☐	☐	☐	☐	☐	☐
D0	☐	☐	☐	☐	☐	☐	☐	☐	☐	☐	☐	☐	☐	☐	☐	☐
E0	☐	☐	☐	☐	☐	☐	☐	☐	☐	☐	☐	☐	☐	☐	☐	☐
F0	☐	☐	☐	☐	☐	☐	☐	☐	☐	☐	☐	☐	☐	☐	☐	☐

n=3

	+0	+1	+2	+3	+4	+5	+6	+7	+8	+9	+A	+B	+C	+D	+E	+F
80																
90																
A0																
B0																
C0																
D0																
E0																
F0																

n=4

	+0	+1	+2	+3	+4	+5	+6	+7	+8	+9	+A	+B	+C	+D	+E	+F
80																
90																
A0																
B0																
C0																
D0																
E0																
F0																

n=5

	+0	+1	+2	+3	+4	+5	+6	+7	+8	+9	+A	+B	+C	+D	+E	+F
80																
90																
A0																
B0																
C0																
D0																
E0																
F0																

n=16

	+0	+1	+2	+3	+4	+5	+6	+7	+8	+9	+A	+B	+C	+D	+E	+F
80																
90																
A0																
B0																
C0																
D0																
E0																
F0																

n=17

	+0	+1	+2	+3	+4	+5	+6	+7	+8	+9	+A	+B	+C	+D	+E	+F
80																
90																
A0																
B0																
C0																
D0																
E0																
F0																

n=18

	+0	+1	+2	+3	+4	+5	+6	+7	+8	+9	+A	+B	+C	+D	+E	+F
80																
90																
A0																
B0																
C0																
D0																
E0																
F0																

n=19

	+0	+1	+2	+3	+4	+5	+6	+7	+8	+9	+A	+B	+C	+D	+E	+F
80																
90																
A0																
B0																
C0																
D0																
E0																
F0																

8. WARRANTY

This display module is guaranteed for 1 year after the shipment from FUTABA.

9. CAUTIONS FOR DETERMINING AND EXPORTING REGULATED GOODS OR SERVICES

This product does not correspond to the goods or services regulated by Japan's Foreign Exchange and Foreign Trade Law. If this product is combined with other products in order to make equipment, whether this product is regulated or not is judged by such newly made equipment. We ask you to determine by yourself whether the equipment corresponds to the regulated goods when this product is incorporated in the equipment.

We also ask you to confirm that this product will not be incorporated in any weapon or used for manufacturing any weapon.

If you export or re-export this product, we recommend you to adopt measures for appropriate export procedures, if any.

10. CAUTIONS FOR OPERATION

10-1. Since VFD are made of glass material.

Avoid applying excessive shock or vibration beyond the specification for the module.
Careful handling is essential.

10-2. Applying lower voltage than the specified may cause non activation for selected pixels.

Conversely, higher voltage may cause may non-selected pixel to be activated.
If such a phenomenon is observed, check the voltage level of the power supply.

10-3. DC/DC converter is equipped on the module, the surge current may be approximately 5 times the specified supply current at the power on.

10-4. Avoid using the module where excessive noise interface is expected.

Noise affects the interface signal and cause improper operation.
Keep the length of the interface cable less than 30cm.
(When the longer cable is required, please confirm there is no noise affection.)

10-5. When fixed pattern is displayed for long time, you may see uneven luminance.

It is recommended to change the display patterns sometimes in order to keep best display quality.

11. The environmental specifications for this product

11-1. With respect to EU RoHS Directive

The contained amount of six prohibited substances in this product , which are cadmium, hexavalent chromium, lead, mercury, polybrominated biphenyl: PBB and polybrominated

diphenyl ether :PBDE, is less than the permitted level stipulated in the EU RoHS Directive, or these substances are not included in the Directive.

The substances excluded are based on Article 4 of the EU RoHS Directive.

11-2. With respect to Chinese RoHS

This product contains only “lead and its compound” from among six controlled substances, which are cadmium, hexavalent chromium, lead, mercury, polybrominated biphenyl: PBB and polybrominated diphenyl ether :PBDE.

The contained amount of the controlled substances except lead and its compound in this product is less than the level stipulated in the Chinese RoHS.

As for the display of information on containing EHS, please refer to the following.

< Display of information on containing EHS >

*Product and part the substances are contained : Vacuum Fluorescent Display(VFD)

*Chemical materials contained : Lead and its compound

*Time limit of use for environmental protection : 10 years

*Reason for containing the substances: No materials are available except them under the current technology.

REMARKS :

The specification is subject to change without prior notice.

Your consultation with FUTABA sales office is recommended for the use of this module.