

### FEATURES

- Non Punch Through Silicon
- Isolated Copper Baseplate
- Low Inductance Internal Construction
- 1600A Per Module

### APPLICATIONS

- High Power Inverters
- Motor Controllers
- Induction Heating
- Resonant Converters

The powerline range of high power modules includes dual and single switch configurations covering voltages from 600V to 3300V and currents up to 4800A.

The GP1600FSS18 is a single switch 1800V, n channel enhancement mode, insulated gate bipolar transistor (IGBT) module. The IGBT has a wide reverse bias safe operating area (RBSOA) ensuring reliability in demanding applications.

The module incorporates an electrically isolated base plate and low inductance construction enabling circuit designers to optimise circuit layouts and utilise earthed heat sinks for safety.

### ORDERING INFORMATION

Order As:

**GP1600FSS18**

Note: When ordering, please use the whole part number.

### KEY PARAMETERS

$V_{CES}$		<b>1800V</b>
$V_{CE(sat)}$	<b>(typ)</b>	<b>3.5V</b>
$I_C$	<b>(max)</b>	<b>1600A</b>
$I_{C(PK)}$	<b>(max)</b>	<b>3200A</b>

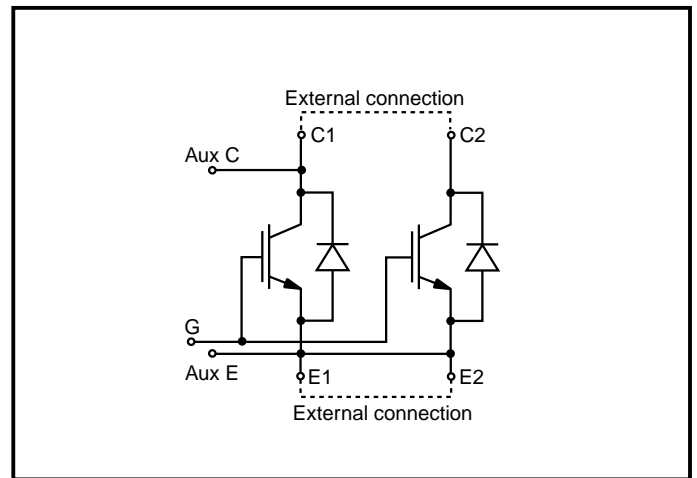

Fig. 1 Single switch circuit diagram

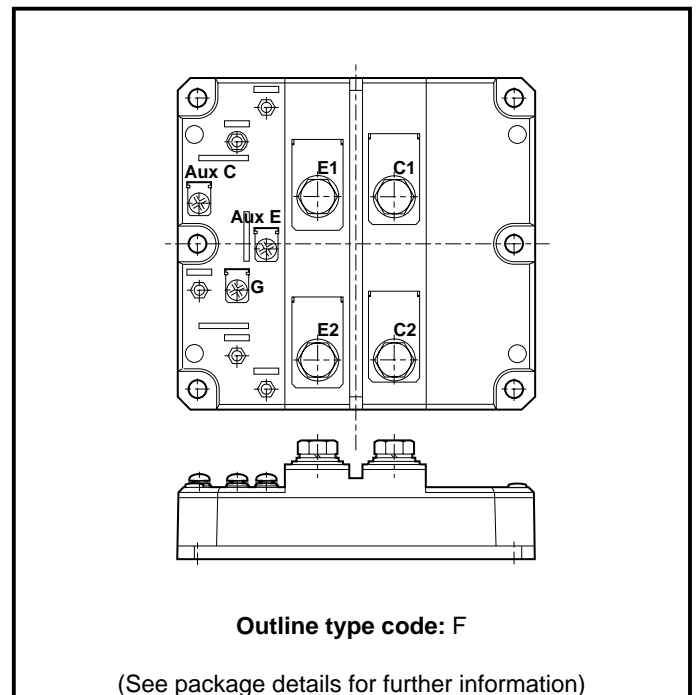

Fig. 2 Electrical connections - (not to scale)

## ABSOLUTE MAXIMUM RATINGS

Stresses above those listed under 'Absolute Maximum Ratings' may cause permanent damage to the device. In extreme conditions, as with all semiconductors, this may include potentially hazardous rupture of the package. Appropriate safety precautions should always be followed. Exposure to Absolute Maximum Ratings may affect device reliability.

$T_{case} = 25^{\circ}\text{C}$  unless stated otherwise

Symbol	Parameter	Test Conditions	Max.	Units
$V_{CES}$	Collector-emitter voltage	$V_{GE} = 0V$	1800	V
$V_{GES}$	Gate-emitter voltage	-	$\pm 20$	V
$I_C$	Continuous collector current	$T_{case} = 50^{\circ}\text{C}$ for $T_j = 125^{\circ}\text{C}$	1600	A
$I_{C(PK)}$	Peak collector current	1ms, $T_{case} = 110^{\circ}\text{C}$	2400	A
$P_{max}$	Max. transistor power dissipation	$T_{case} = 25^{\circ}\text{C}$ , $T_j = 150^{\circ}\text{C}$	11.4	kW
$V_{isol}$	Isolation voltage	Commoned terminals to base plate. AC RMS, 1 min, 50Hz	4000	V

## THERMAL AND MECHANICAL RATINGS

Symbol	Parameter	Test Conditions	Min.	Max.	Units
$R_{th(j-c)}$	Thermal resistance - transistor	Continuous dissipation - junction to case	-	11	$^{\circ}\text{C}/\text{kW}$
$R_{th(j-c)}$	Thermal resistance - diode	Continuous dissipation - junction to case	-	20	$^{\circ}\text{C}/\text{kW}$
$R_{th(c-h)}$	Thermal resistance - case to heatsink (per module)	Mounting torque 5Nm (with mounting grease)	-	8	$^{\circ}\text{C}/\text{kW}$
$T_j$	Junction temperature	Transistor	-	150	$^{\circ}\text{C}$
		Diode	-	125	$^{\circ}\text{C}$
$T_{stg}$	Storage temperature range	-	-40	125	$^{\circ}\text{C}$
-	Screw torque	Mounting - M6	-	5	Nm
		Electrical connections - M4	-	2	Nm
		Electrical connections - M8	-	10	Nm

**ELECTRICAL CHARACTERISTICS**
 $T_{case} = 25^{\circ}\text{C}$  unless stated otherwise.

Symbol	Parameter	Test Conditions	Min.	Typ.	Max.	Units
$I_{CES}$	Collector cut-off current	$V_{GE} = 0\text{V}, V_{CE} = V_{CES}$	-	-	2	mA
		$V_{GE} = 0\text{V}, V_{CE} = V_{CES}, T_{case} = 125^{\circ}\text{C}$	-	-	50	mA
$I_{GES}$	Gate leakage current	$V_{GE} = \pm 20\text{V}, V_{CE} = 0\text{V}$	-	-	8	$\mu\text{A}$
$V_{GE(TH)}$	Gate threshold voltage	$I_C = 80\text{mA}, V_{GE} = V_{CE}$	4.5	5.5	6.5	V
$V_{CE(sat)}$	Collector-emitter saturation voltage	$V_{GE} = 15\text{V}, I_C = 1600\text{A}$	-	3.5	4	V
		$V_{GE} = 15\text{V}, I_C = 1600\text{A}, T_{case} = 125^{\circ}\text{C}$	-	4.3	5	V
$I_F$	Diode forward current	DC	-	-	1600	A
$I_{FM}$	Diode maximum forward current	$t_p = 1\text{ms}$	-	-	3200	A
$V_F$	Diode forward voltage	$I_F = 1600\text{A}$	-	2.2	2.5	V
		$I_F = 1600\text{A}, T_{case} = 125^{\circ}\text{C}$	-	2.3	2.6	V
$C_{ies}$	Input capacitance	$V_{CE} = 25\text{V}, V_{GE} = 0\text{V}, f = 1\text{MHz}$	-	180	-	nF
$L_M$	Module inductance	-	-	15	-	nH

## ELECTRICAL CHARACTERISTICS

 $T_{\text{case}} = 25^{\circ}\text{C}$  unless stated otherwise

Symbol	Parameter	Test Conditions	Min.	Typ.	Max.	Units
$t_{\text{d(off)}}$	Turn-off delay time	$I_{\text{C}} = 1600\text{A}$	-	1500	1650	ns
$t_{\text{f}}$	Fall time	$V_{\text{GE}} = \pm 15\text{V}$	-	200	300	ns
$E_{\text{OFF}}$	Turn-off energy loss	$V_{\text{CE}} = 900\text{V}$	-	500	650	mJ
$t_{\text{d(on)}}$	Turn-on delay time	$R_{\text{G(ON)}} = R_{\text{G(OFF)}} = 2.2\Omega$	-	400	550	ns
$t_{\text{r}}$	Rise time	$L \sim 50\text{nH}$	-	300	450	ns
$E_{\text{ON}}$	Turn-on energy loss		-	450	650	mJ
$Q_{\text{rr}}$	Diode reverse recovery charge	$I_{\text{F}} = 1600\text{A}, V_{\text{R}} = 50\% V_{\text{CES}}$	-	300	400	$\mu\text{C}$
$I_{\text{rr}}$	Diode reverse current	$dI_{\text{F}}/dt = 6000\text{A}/\mu\text{s}$	-	750	-	A
$E_{\text{REC}}$	Diode reverse recovery energy		-	200	-	mJ

 $T_{\text{case}} = 125^{\circ}\text{C}$  unless stated otherwise

Symbol	Parameter	Test Conditions	Min.	Typ.	Max.	Units
$t_{\text{d(off)}}$	Turn-off delay time	$I_{\text{C}} = 1600\text{A}$	-	1700	1900	ns
$t_{\text{f}}$	Fall time	$V_{\text{GE}} = \pm 15\text{V}$	-	200	330	ns
$E_{\text{OFF}}$	Turn-off energy loss	$V_{\text{CE}} = 900\text{V}$	-	650	800	mJ
$t_{\text{d(on)}}$	Turn-on delay time	$R_{\text{G(ON)}} = R_{\text{G(OFF)}} = 2.2\Omega$	-	500	700	ns
$t_{\text{r}}$	Rise time	$L \sim 50\text{nH}$	-	350	500	ns
$E_{\text{ON}}$	Turn-on energy loss		-	600	800	mJ
$Q_{\text{rr}}$	Diode reverse recovery charge	$I_{\text{F}} = 1600\text{A}, V_{\text{R}} = 50\% V_{\text{CES}}$	-	550	650	$\mu\text{C}$
$I_{\text{rr}}$	Diode reverse current	$dI_{\text{F}}/dt = 5000\text{A}/\mu\text{s}$	-	850	-	A
$E_{\text{REC}}$	Diode reverse recovery energy		-	320	-	mJ

**TYPICAL CHARACTERISTICS**

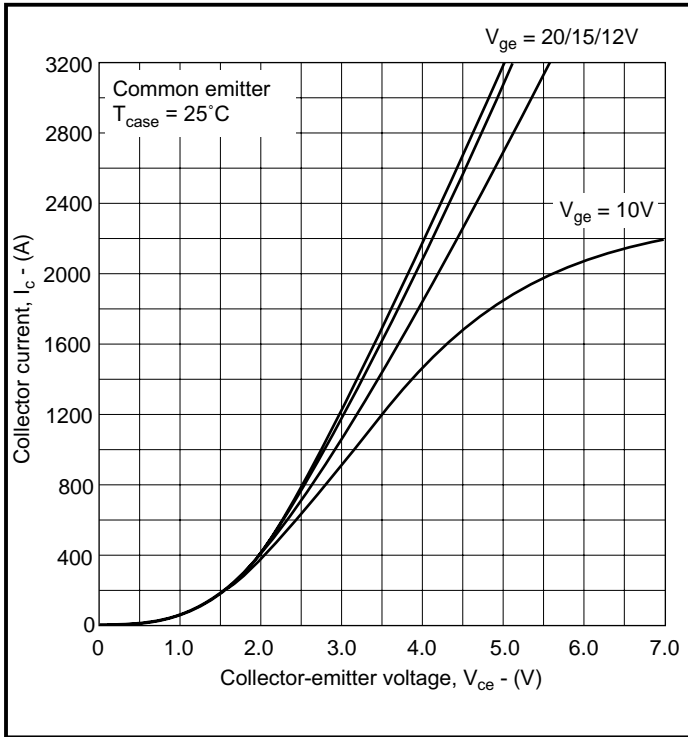

**Fig. 3 Typical output characteristics**

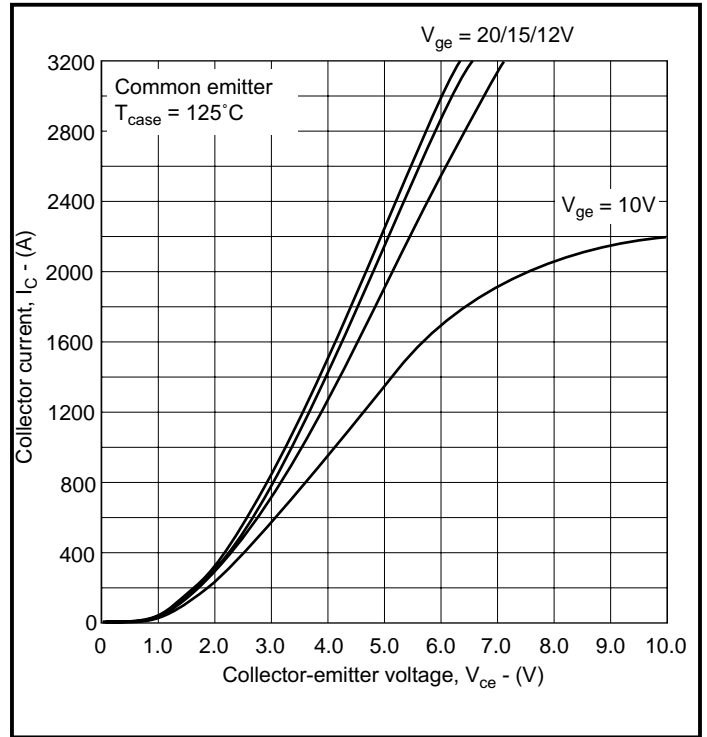

**Fig. 4 Typical output characteristics**

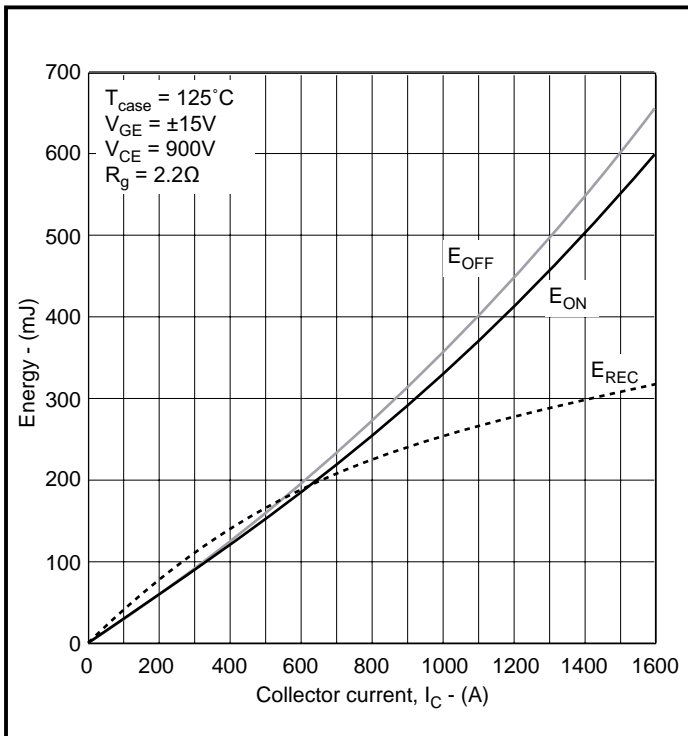

**Fig. 5 Typical switching energy vs collector current**

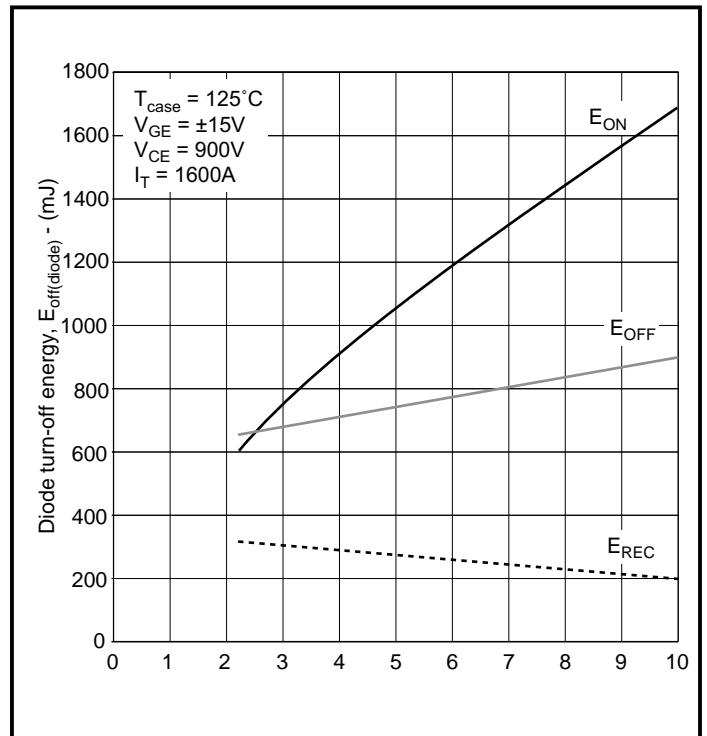

**Fig. 6 Typical switching energy vs gate resistance**

Caution: This device is sensitive to electrostatic discharge. Users should follow ESD handling procedures.

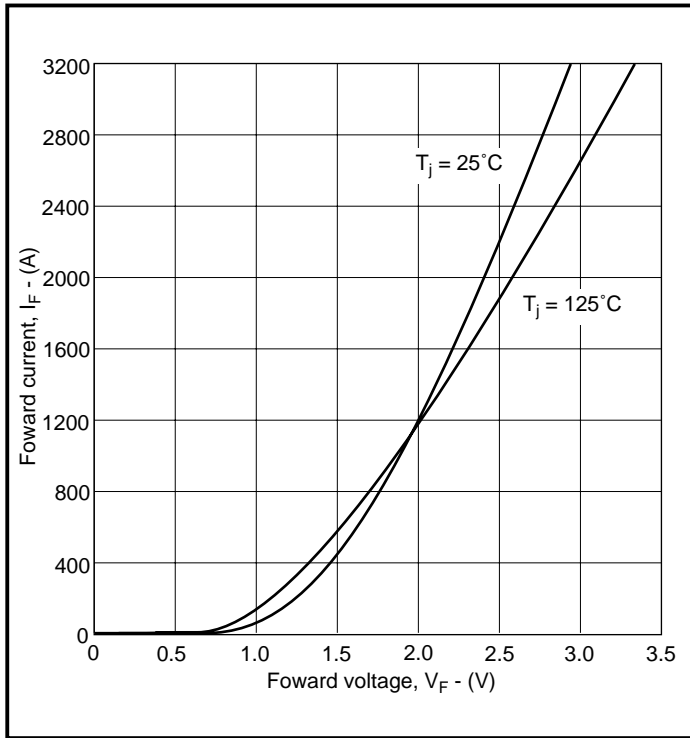

Fig. 7 Diode typical forward characteristics

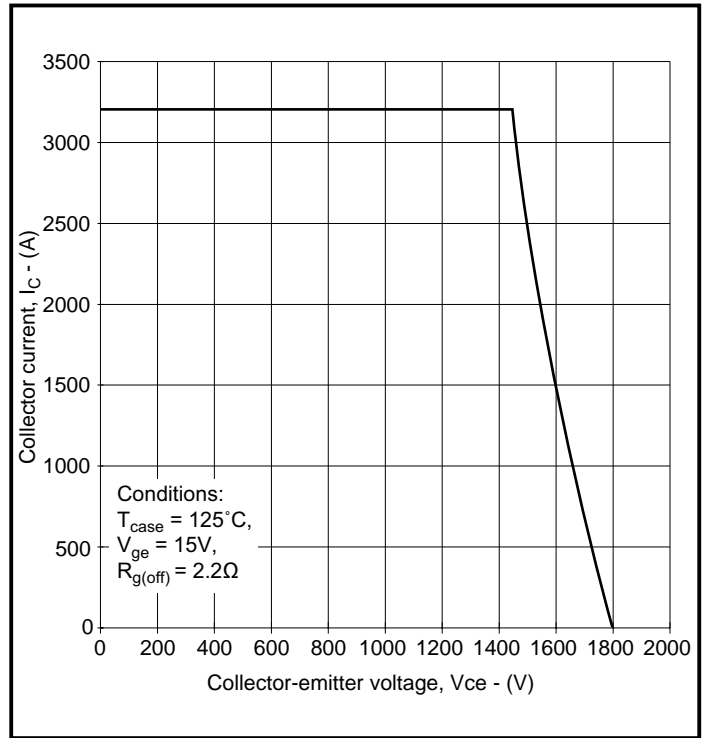

Fig. 8 Reverse bias safe operating area

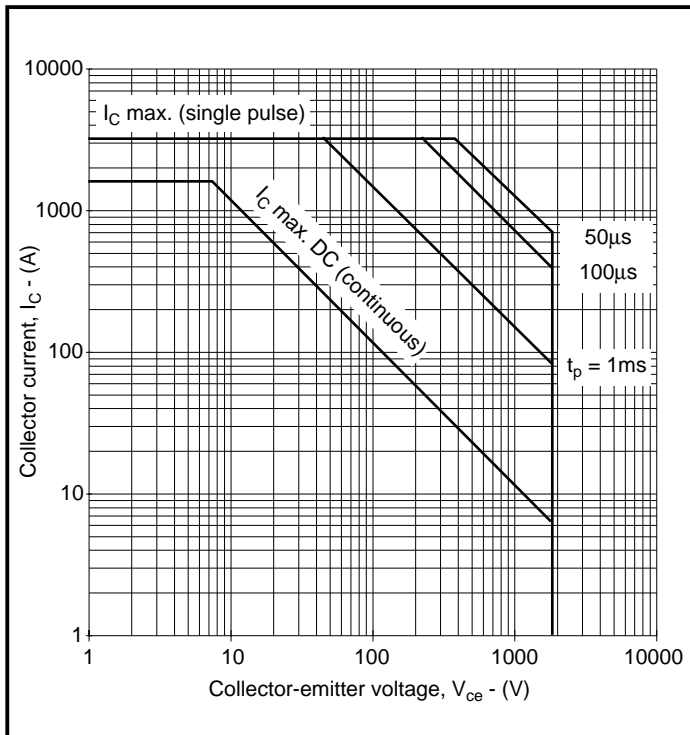

Fig. 9 Forward bias safe operating area

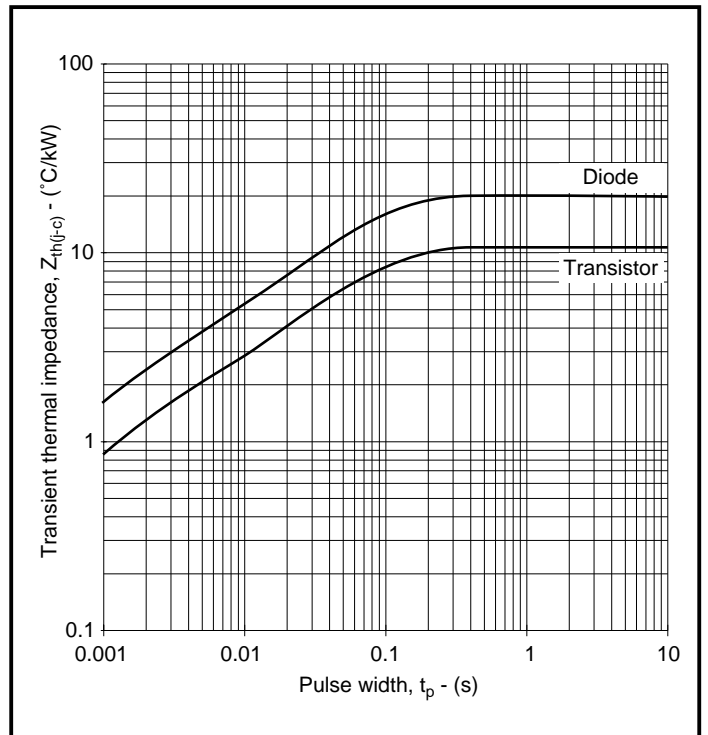
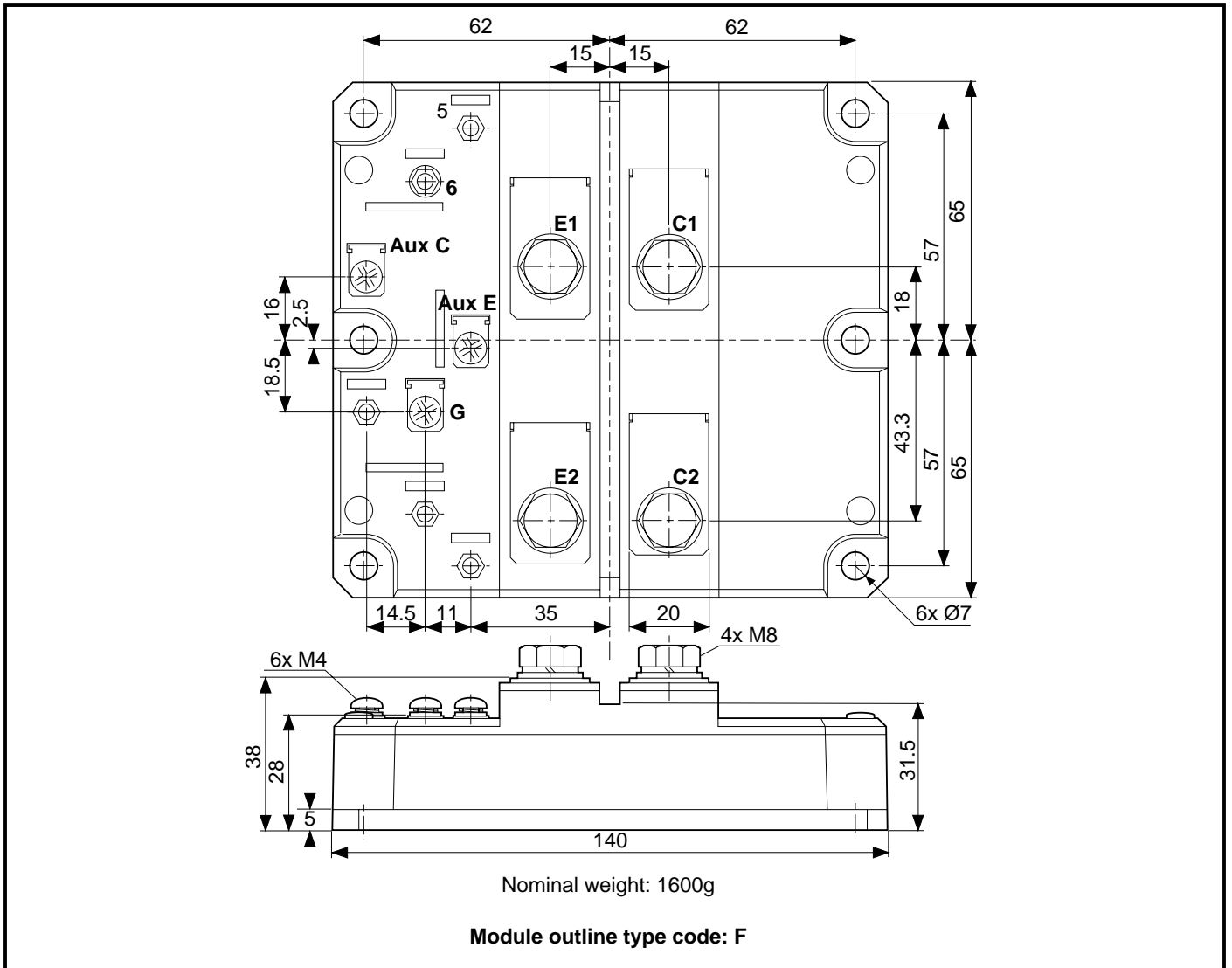

Fig. 10 Transient thermal impedance

**PACKAGE DETAILS**

For further package information, please visit our website or contact your nearest Customer Service Centre. All dimensions in mm, unless stated otherwise. DO NOT SCALE.



## ASSOCIATED PUBLICATIONS

Title	Application Note Number
Electrostatic handling precautions	AN4502
An introduction to IGBTs	AN4503
IGBT ratings and characteristics	AN4504
Heatsink requirements for IGBT modules	AN4505
Calculating the junction temperature of power semiconductors	AN4506
Gate drive considerations to maximise IGBT efficiency	AN4507
Parallel operation of IGBTs – punch through vs non-punch through characteristics	AN4508
Guidance notes for formulating technical enquiries	AN4869
Principle of rating parallel connected IGBT modules	AN5000
Short circuit withstand capability in IGBTs	AN5167
Driving Dynex Semiconductor IGBT modules with Concept gate drivers	AN5384

## POWER ASSEMBLY CAPABILITY

The Power Assembly group was set up to provide a support service for those customers requiring more than the basic semiconductor, and has developed a flexible range of heatsink and clamping systems in line with advances in device voltages and current capability of our semiconductors.

We offer an extensive range of air and liquid cooled assemblies covering the full range of circuit designs in general use today. The Assembly group continues to offer high quality engineering support dedicated to designing new units to satisfy the growing needs of our customers.

Using the latest CAD methods our team of design and applications engineers aim to provide the Power Assembly Complete Solution (PACs).

## HEATSINKS

The Power Assembly group has its own proprietary range of extruded aluminium heatsinks. They have been designed to optimise the performance of Dynex semiconductors. Data with respect to air natural, forced air and liquid cooling (with flow rates) is available on request.

For further information on device clamps, heatsinks and assemblies, please contact your nearest sales representative or customer service office.





<http://www.dynexsemi.com>

**e-mail: [power\\_solutions@dynexsemi.com](mailto:power_solutions@dynexsemi.com)**

---

**HEADQUARTERS OPERATIONS****DYNEX SEMICONDUCTOR LTD**

Doddington Road, Lincoln.  
Lincolnshire. LN6 3LF. United Kingdom.  
Tel: 00-44-(0)1522-500500  
Fax: 00-44-(0)1522-500550

**DYNEX POWER INC.**

99 Bank Street, Suite 410,  
Ottawa, Ontario, Canada, K1P 6B9  
Tel: 613.723.7035  
Fax: 613.723.1518  
Toll Free: 1.888.33.DYNEX (39639)

**CUSTOMER SERVICE CENTRES**

**Central Europe** Tel: +33 (0)1 58 04 91 00. Fax: +33 (0)1 46 38 51 33  
**North America** Tel: 011-800-5554-5554. Fax: 011-800-5444-5444  
**UK, Scandinavia & Rest Of World** Tel: +44 (0)1522 500500. Fax: +44 (0)1522 500020

**SALES OFFICES**

**Central Europe** Tel: +33 (0)1 58 04 91 00. Fax: +33 (0)1 46 38 51 33  
**North America** Tel: (613) 723-7035. Fax: (613) 723-1518. Toll Free: 1.888.33.DYNEX (39639) /  
Tel: (949) 733-3005. Fax: (949) 733-2986.  
**UK, Scandinavia & Rest Of World** Tel: +44 (0)1522 500500. Fax: +44 (0)1522 500020

These offices are supported by Representatives and Distributors in many countries world-wide.  
© Dynex Semiconductor 2001 Publication No. DS5176-4 Issue No. 4.2 January 2001  
TECHNICAL DOCUMENTATION – NOT FOR RESALE. PRINTED IN UNITED KINGDOM

---

**Datasheet Annotations:**

Dynex Semiconductor annotate datasheets in the top right hand corner of the front page, to indicate product status. The annotations are as follows:-

**Target Information:** This is the most tentative form of information and represents a very preliminary specification. No actual design work on the product has been started.

**Preliminary Information:** The product is in design and development. The datasheet represents the product as it is understood but details may change.

**Advance Information:** The product design is complete and final characterisation for volume production is well in hand.

**No Annotation:** The product parameters are fixed and the product is available to datasheet specification.

---

This publication is issued to provide information only which (unless agreed by the Company in writing) may not be used, applied or reproduced for any purpose nor form part of any order or contract nor to be regarded as a representation relating to the products or services concerned. No warranty or guarantee express or implied is made regarding the capability, performance or suitability of any product or service. The Company reserves the right to alter without prior notice the specification, design or price of any product or service. Information concerning possible methods of use is provided as a guide only and does not constitute any guarantee that such methods of use will be satisfactory in a specific piece of equipment. It is the user's responsibility to fully determine the performance and suitability of any equipment using such information and to ensure that any publication or data used is up to date and has not been superseded. These products are not suitable for use in any medical products whose failure to perform may result in significant injury or death to the user. All products and materials are sold and services provided subject to the Company's conditions of sale, which are available on request.

All brand names and product names used in this publication are trademarks, registered trademarks or trade names of their respective owners.

---

Caution: This device is sensitive to electrostatic discharge. Users should follow ESD handling procedures.

**[www.dynexsemi.com](http://www.dynexsemi.com)**