

GP1A05EJ000F Series

Gap : 5mm, Slit : 0.5mm
*OPIC Output
Transmissive Photointerrupter
with Connector



■ Description

GP1A05EJ000F Series are standard, OPIC output, transmissive photointerrupters with opposing emitter and detector in a case, providing non-contact sensing. For this family of devices, the emitter and detector are inserted in a case, and a 3-pin connector is included to allow remote-mount or off-board designs.

■ Features

1. Transmissive with OPIC output
2. Highlights :
 - Includes additional screw fixing holes
 - Positioning Pin to prevent misalignment
3. Key Parameters :
 - Gap Width : 5mm
 - Slit Width (detector side) : 0.5mm
 - Package : 34×18×11mm (without connector and positioning pin)
 - Connector : **GP1A05EJ000F** ; Tyco Electronics AMP K.K. (PN : 171825-3)
GP1A05E2J00F ; J.S.T. Mfg Co., Ltd. (PN : B3P-SHF-IAA (LF))
 - Output Type : Low when the object is present.
4. Lead free and RoHS directive compliant

■ Agency approvals/Compliance

1. Compliant with RoHS directive

■ Applications

1. General purpose detection of object presence or motion.
2. Example: PPC, FAX, Printer

* "OPIC"(Optical IC) is a trademark of the SHARP Corporation. An OPIC consists of a light-detecting element and a signal-processing

Notice The content of data sheet is subject to change without prior notice.
In the absence of confirmation by device specification sheets, SHARP takes no responsibility for any defects that may occur in equipment using any SHARP devices shown in catalogs, data books, etc. Contact SHARP in order to obtain the latest device specification sheets before using any SHARP device.

Internal Connection Diagram

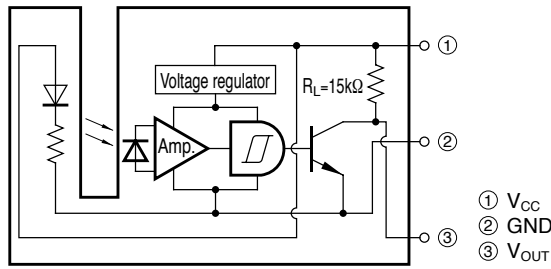

Truth table

Condition	Output
Light beam interrupted	Low
Light beam uninterrupted	High

Outline Dimensions

(Unit : mm)

GP1A05EJ00F

Connector : 171825-3 (Tyco Electronics AMP K.K.)

Connector terminal plating material : Sn

GP1A05E2J00F

Connector : B3P-SHF-1AA (J.S.T. MFG. CO., LTD.)

Connector terminal plating material : Sn

• Unspecified tolerance shall be as follows ;

Dimensions	Tolerance
less than 4	±0.2
4 or more less than 16	±0.3
16 or more	±0.5

Product mass : approx. 3.0g

• Unspecified tolerance shall be as follows ;

Dimensions	Tolerance
less than 4	±0.2
4 or more less than 16	±0.3
16 or more	±0.5

Product mass : approx. 3.0g

Date code

Year of production	Month of production	
	Month	Mark
Last two digits of Christian year.	1	1
	2	2
	3	3
	4	4
	5	5
	6	6
	7	7
	8	8
	9	9
	10	X
	11	Y
	12	Z

Country of origin

Japan or Philippines

(Indicated on the packing case)

■ Absolute Maximum Ratings ($T_a=25^\circ\text{C}$)

Parameter	Symbol	Rating	Unit
Supply voltage	V_{CC}	-0.5 to +8	V
*1 Low level output current	I_{OL}	50	mA
*2 Operating temperature	T_{opr}	-20 to +75	$^\circ\text{C}$
*2 Storage temperature	T_{stg}	-40 to +85	$^\circ\text{C}$

*1 Collector current of output transistor, refer to Fig.1.

*2 The connector should be plugged in/out at normal temperature.

■ Electro-optical Characteristics ($V_{CC}=5\text{V}, T_a=25^\circ\text{C}$)

Parameter	Symbol	Conditions	MIN.	TYP.	MAX.	Unit
Low level supply current	I_{CCL}	Light beam interrupted	-	-	30	mA
Low level output voltage	V_{OL}	Light beam interrupted, $I_{OL}=16\text{mA}$	-	-	0.35	V
High level supply current	I_{CCH}	Light beam uninterrupted	-	-	30	mA
High level output voltage	V_{OH}	Light beam uninterrupted	$V_{CC}\times 0.9$	-	-	V
*3 Response frequency	f	No DC output is allowed	-	-	3 000	Hz
Operating supply voltage	V_{CC}	-	4.5	-	5.5	V

*3 Response frequency is measured with the disk shown below being rotated.

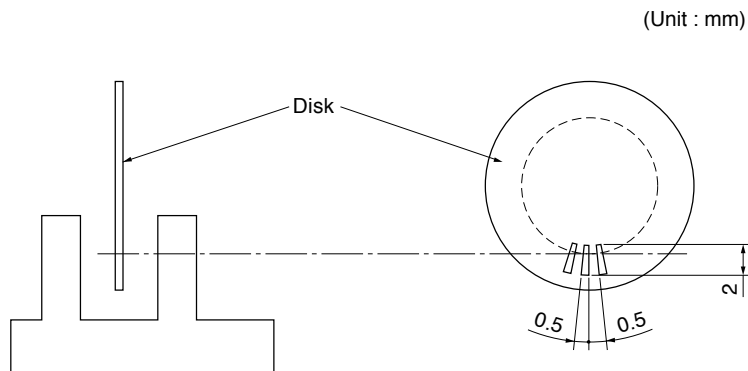

Fig.1 Low Level Output Current vs. Ambient Temperature

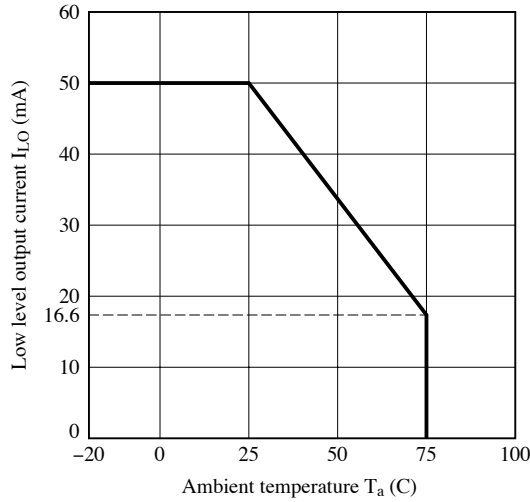

Fig.2 Low Level Output Voltage vs. Low Level Output Current

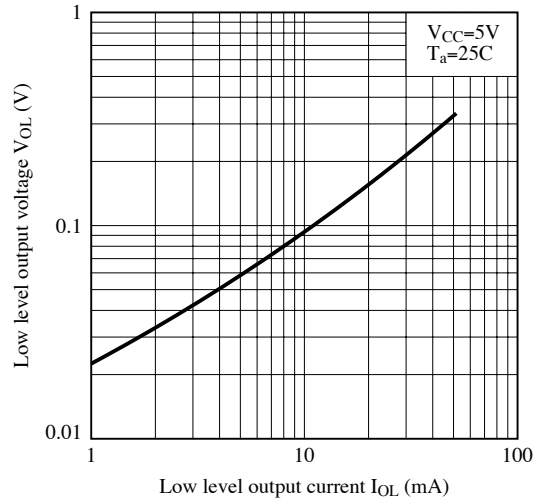

Fig.3 Low Level Output Voltage vs. Ambient Temperature

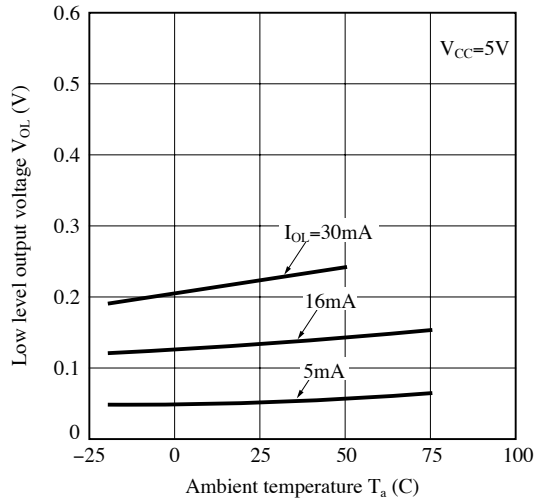

Fig.4 Supply Current vs. Supply Voltage

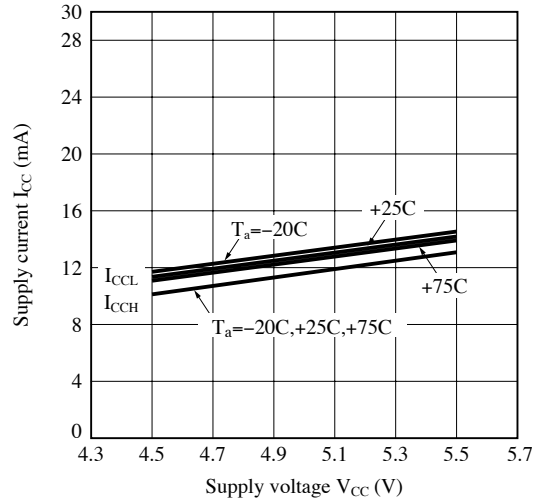

Fig.5 Detecting Position Characteristics (1)

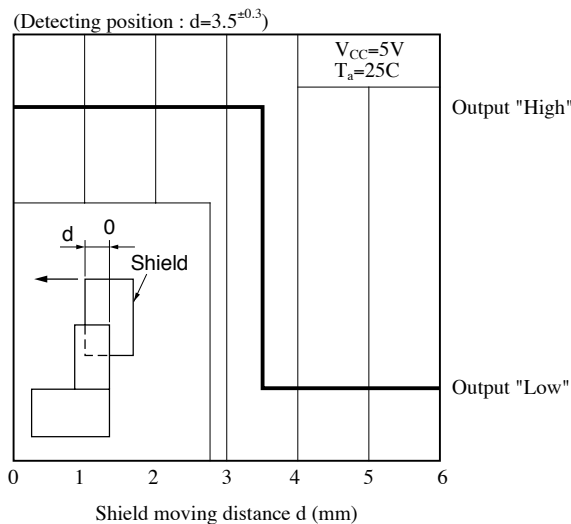
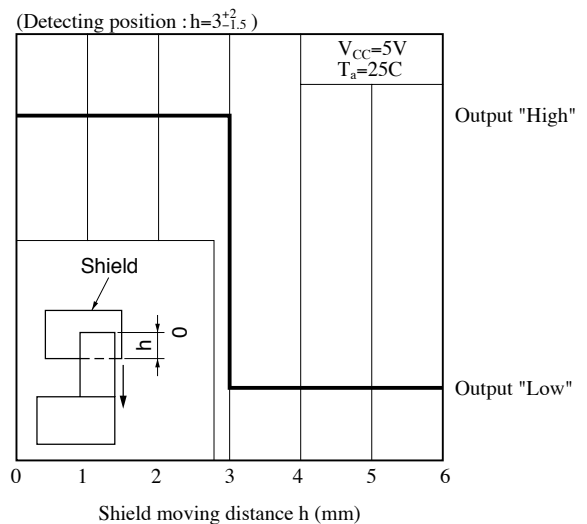

Fig.6 Detecting Position Characteristics (2)



Remarks : Please be aware that all data in the graph are just for reference and not for guarantee.

■ **Design Considerations**

● **Design guide**

- 1) Prevention of detection error
To prevent photointerrupter from faulty operation caused by external light, do not set the detecting face to the external light.
- 2) In order to stabilize power supply line, connect a by-pass capacitor of more than 0.01 μ F between V_{CC} and GND near the device.
- 3) When the sensor is connected with long wire, noise might be on the signal from the sensor while it is going through the wire. To avoid this problem, please evaluate the sensor under actual usage condition to make sure that the system works fine.
- 4) Position of opaque board
Opaque board shall be installed at place 5mm or more from the top of elements.

(Example)

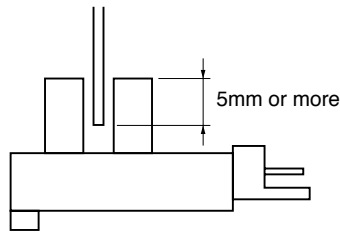

- 5) Screw tightening torque
The tightening torque for screwing should be 0.6N·m or less.

This product is not designed against irradiation and incorporates non-coherent IRED.

● **Parts**

This product is assembled using the below parts.

- Photodetector (qty. : 1) [Using a silicon photodiode as light detecting portion, and a bipolar IC as signal processing circuit]

Category	Maximum Sensitivity wavelength (nm)	Sensitivity wavelength (nm)	Response time (μ s)
Photodiode	900	400 to 1 200	3

- Photo emitter (qty. : 1)

Category	Material	Maximum light emitting wavelength (nm)	I/O Frequency (MHz)
Infrared emitting diode (non-coherent)	Gallium arsenide (GaAs)	950	0.3

- Material

Case	Connector terminal finish
Black Polycarbonate resin (UL94 HB)	Sn plating

- Others

Laser generator is not used.

■ Manufacturing Guidelines**● Notes of cleaning**

Please carry out neither the immersion cleaning nor the ultrasonic cleaning to avoid the solvent residue inside the case.

When necessary, dust and stain shall clean by air-blow or wipe off by soft cloth soaked in cleaning agent. The cleaning agent used to wipe off must use only the following kind. Ethyl alcohol, Methyl alcohol and Iso-propyl alcohol.

● Presence of ODC

This product shall not contain the following materials.

And they are not used in the production process for this product.

Regulation substances : CFCs, Halon, Carbon tetrachloride, 1.1.1-Trichloroethane (Methylchloroform)

Specific brominated flame retardants such as the PBBOs and PBBs are not used in this product at all.

This product shall not contain the following materials banned in the RoHS Directive (2002/95/EC).

•Lead, Mercury, Cadmium, Hexavalent chromium, Polybrominated biphenyls (PBB), Polybrominated diphenyl ethers (PBDE).

■ Package specification**● Case package**

Package materials

Anti-static plastic bag : Polyethylene

Moltopren : Urethane

Partition : Corrugated fiberboard

Packing case : Corrugated fiberboard

Package method

75 pcs of products shall be packaged in a plastic bag, Ends shall be sealed by stapler. The bottom of the packing case is covered with moltopren, and the partition is set in the packing case. Each partition should have 1 plastic bag.

Moltopren should be located after all product are settled (1 packing conteains 150 pcs).

Packing composition

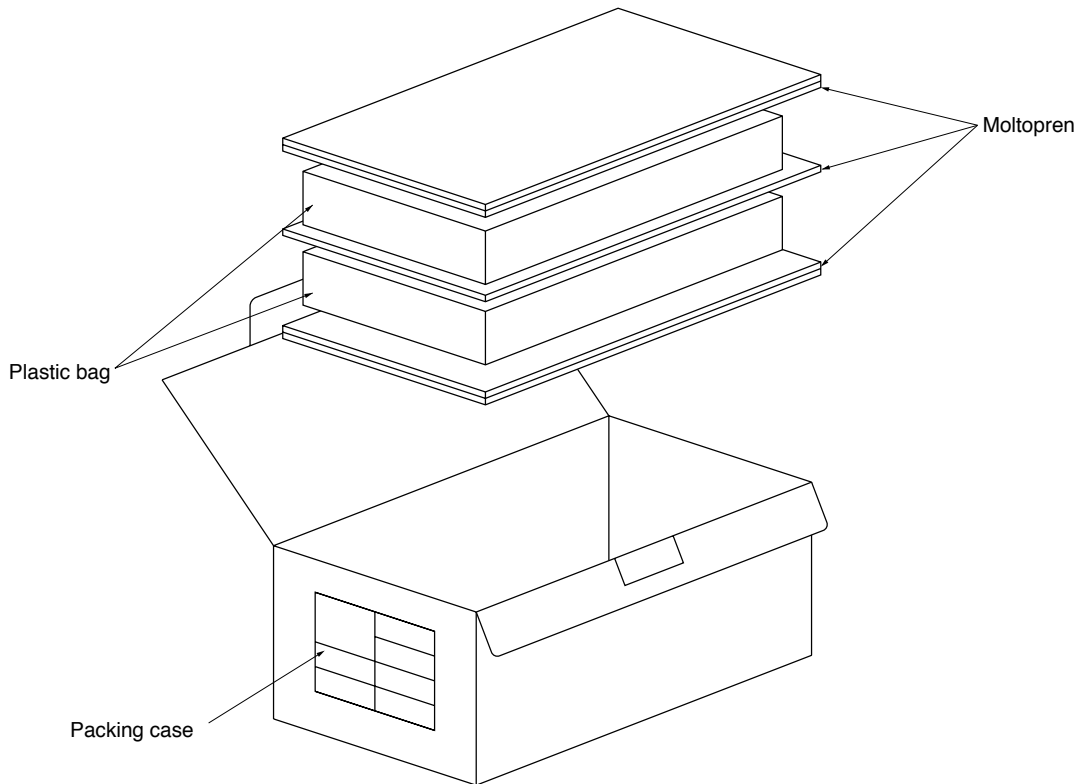

■ Important Notices

· The circuit application examples in this publication are provided to explain representative applications of SHARP devices and are not intended to guarantee any circuit design or license any intellectual property rights. SHARP takes no responsibility for any problems related to any intellectual property right of a third party resulting from the use of SHARP's devices.

· Contact SHARP in order to obtain the latest device specification sheets before using any SHARP device. SHARP reserves the right to make changes in the specifications, characteristics, data, materials, structure, and other contents described herein at any time without notice in order to improve design or reliability. Manufacturing locations are also subject to change without notice.

· Observe the following points when using any devices in this publication. SHARP takes no responsibility for damage caused by improper use of the devices which does not meet the conditions and absolute maximum ratings to be used specified in the relevant specification sheet nor meet the following conditions:

(i) The devices in this publication are designed for use in general electronic equipment designs such as:

- Personal computers
- Office automation equipment
- Telecommunication equipment [terminal]
- Test and measurement equipment
- Industrial control
- Audio visual equipment
- Consumer electronics

(ii) Measures such as fail-safe function and redundant design should be taken to ensure reliability and safety when SHARP devices are used for or in connection

with equipment that requires higher reliability such as:

- Transportation control and safety equipment (i.e., aircraft, trains, automobiles, etc.)
- Traffic signals
- Gas leakage sensor breakers
- Alarm equipment
- Various safety devices, etc.

(iii) SHARP devices shall not be used for or in connection with equipment that requires an extremely high level of reliability and safety such as:

- Space applications
- Telecommunication equipment [trunk lines]
- Nuclear power control equipment
- Medical and other life support equipment (e.g., scuba).

· If the SHARP devices listed in this publication fall within the scope of strategic products described in the Foreign Exchange and Foreign Trade Law of Japan, it is necessary to obtain approval to export such SHARP devices.

· This publication is the proprietary product of SHARP and is copyrighted, with all rights reserved. Under the copyright laws, no part of this publication may be reproduced or transmitted in any form or by any means, electronic or mechanical, for any purpose, in whole or in part, without the express written permission of SHARP. Express written permission is also required before any use of this publication may be made by a third party.

· Contact and consult with a SHARP representative if there are any questions about the contents of this publication.