

GP1A70R/GP1A71R

OPIC Photointerrupter with Encoder Functions

■ Features

1. 2-phase (A, B) digital output
2. Sensing accuracy
(**GP1A70R** Disk slit pitch : 1.14mm)
(**GP1A71R** Disk slit pitch : 0.7mm)
3. PWB mounting type
(Lead bending type)
4. TTL compatible output
5. Compact, lightweight

■ Applications

1. Printers
2. Copiers
3. Numerical control machines

■ Outline Dimensions

(Unit : mm)

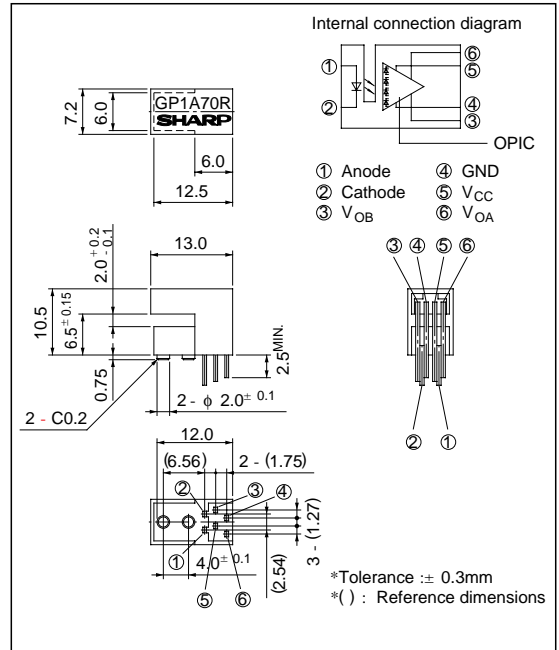

**"OPIC" (Optical IC) is a trademark of the SHARP Corporation.
An OPIC consists of a light-detecting element and signal-processing circuit integrated onto a single chip.

■ Absolute Maximum Ratings

(Ta = 25°C)

	Parameter	Symbol	Rating	Unit
Input	Forward current	I _F	50	mA
	*1 Peak forward current	I _{FM}	1	A
	Reverse voltage	V _R	6	V
	Power dissipation	P	75	mW
Output	Supply voltage	V _{CC}	7	V
	Low level output current	I _{OL}	20	mA
	Power dissipation	P _O	250	mW
	Operating temperature	T _{opr}	0 to + 70	°C
	Storage temperature	T _{stg}	- 40 to + 80	°C
	*2 Soldering temperature	T _{sol}	260	°C

*1 Pulse width ≤ 100μs, Duty ratio 0.01

*2 For 5 seconds

Electro-optical Characteristics

(Ta = 25°C unless otherwise specified)

Parameter		Symbol	Conditions	MIN.	TYP.	MAX.	Unit
Input	Forward voltage	V_F	$I_F = 20\text{mA}, T_a = 25^\circ\text{C}$	-	1.2	1.4	V
	Reverse current	I_R	$V_R = 3\text{V}, T_a = 25^\circ\text{C}$	-	-	10	μA
Output	Operating supply voltage	V_{CC}		4.5	5.0	5.5	V
	High level output voltage	V_{OH}	^{*3} $V_{CC} = 5\text{V}, I_F = 20\text{mA}$	2.4	4.9	-	V
	Low level output voltage	V_{OL}	^{*3} $I_{OL} = 8\text{mA}, V_{CC} = 5\text{V}, I_F = 20\text{mA}$	-	0.1	0.4	V
	Supply current	I_{CC}	^{*4} $V_{CC} = 5\text{V}, I_F = 20\text{mA}$	-	5	20	mA
	Duty ratio	GP1A70R GP1A71R	^{*5} D_A, D_B	^{*3} $V_{CC} = 5\text{V}, I_F = 20\text{mA}, f = 2.5\text{kHz}$	25	50	75
Transfer characteristics	Response frequency	$f_{MAX.}$	^{*3} $V_{CC} = 5\text{V}, I_F = 20\text{mA}$	-	-	10	kHz

*3 Measured under the condition shown in Measurement Conditions.

*4 In the condition that output A and B are low level.

*5 $D_A: \frac{t_{AH}}{t_{AP}} \times 100, D_B: \frac{t_{BH}}{t_{BP}} \times 100$, Duty ratio: Average disk rotation time per turn

Output Waveforms

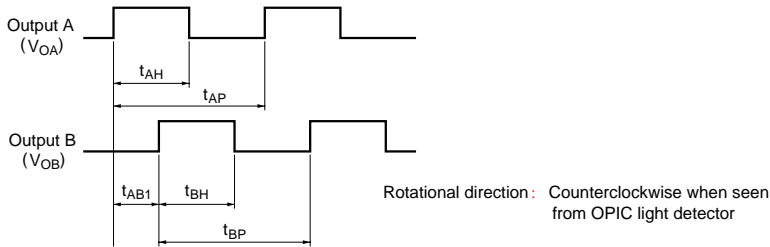

Fig. 1 Forward Current vs. Ambient Temperature

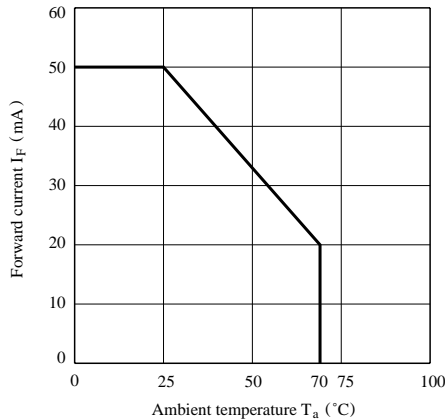

Fig. 2 Output Power Dissipation vs. Ambient Temperature

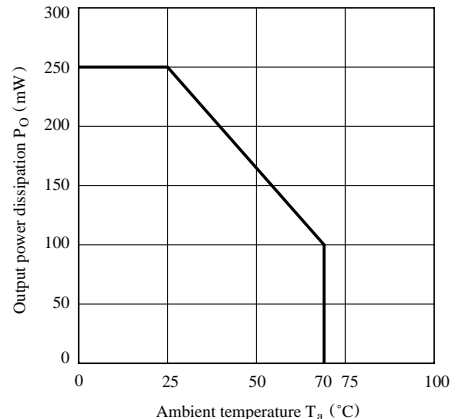

Fig. 3-a Duty Ratio vs. Frequency (GP1A70R)

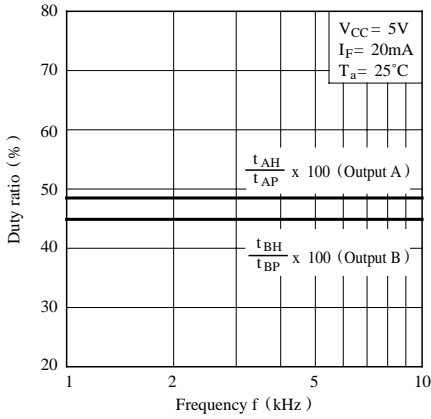

Fig. 3-b Duty Ratio vs. Frequency (GP1A71R)

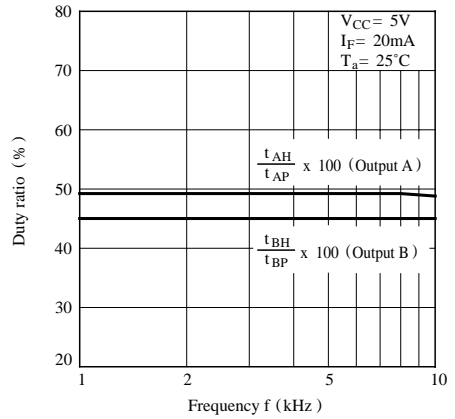

Fig. 4-a Phase Difference vs. Frequency (GP1A70R)

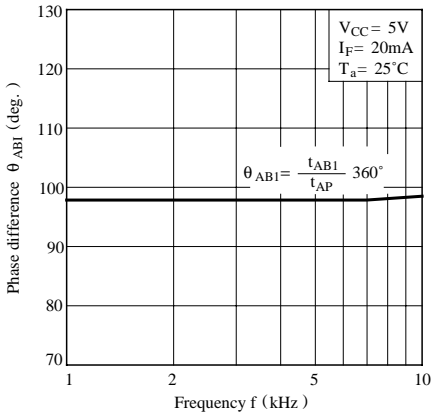

Fig. 4-b Phase Difference vs. Frequency (GP1A71R)

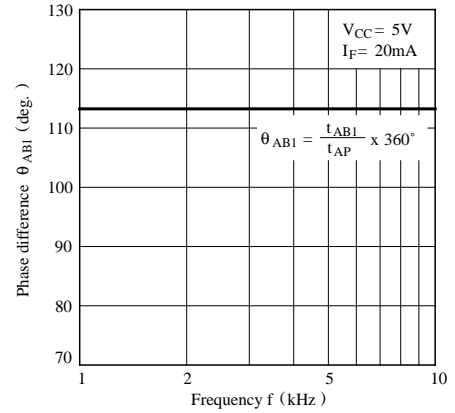

Fig. 5-a Duty Ratio vs. Ambient Temperature (GP1A70R)

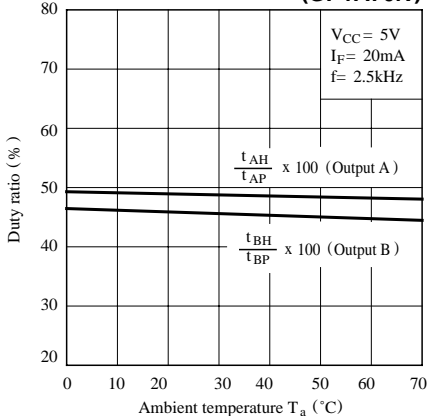

Fig. 5-b Duty Ratio vs. Ambient Temperature (GP1A71R)

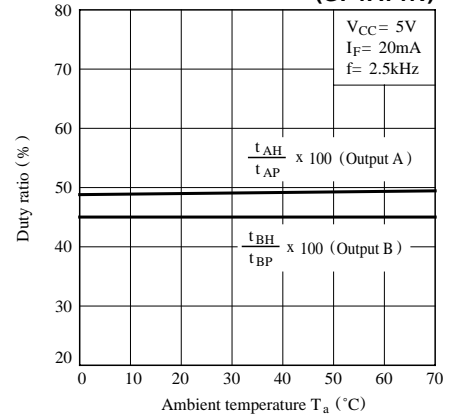

Fig. 6-a Phase Difference vs. Ambient Temperature

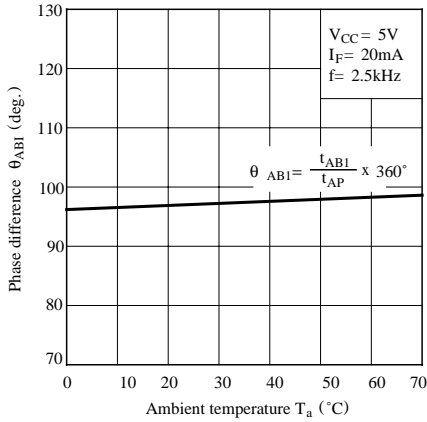

Fig. 6-b Phase Difference vs. Ambient Temperature

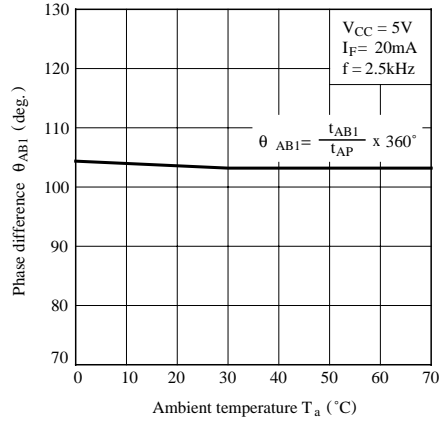

Fig. 7-a Duty Ratio vs. Distance (Xdirection)

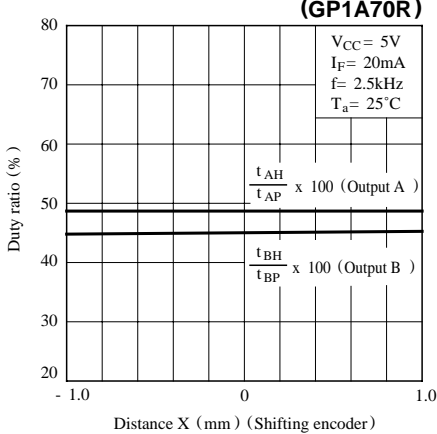

Fig. 7-b Duty Ratio vs. Distance (X direction)

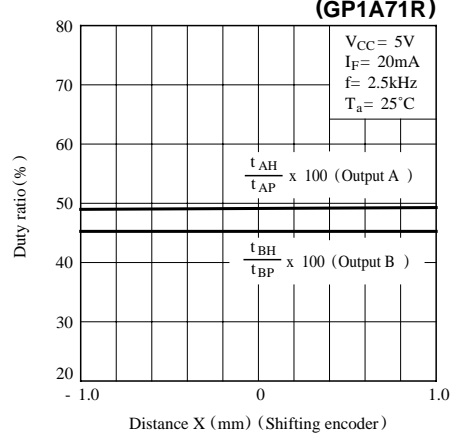

Fig. 8-a Phase Difference vs. Distance (X direction)

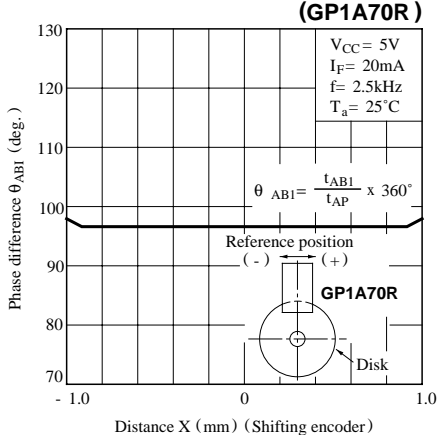

Fig. 8-b Phase Difference vs. Distance (X direction)

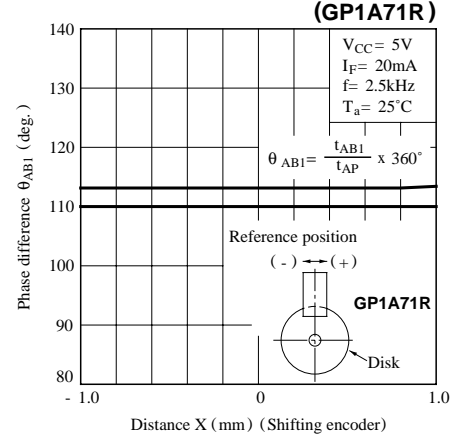

Fig. 9-a Duty Ratio vs. Distance (Ydirection) (GP1A70R)

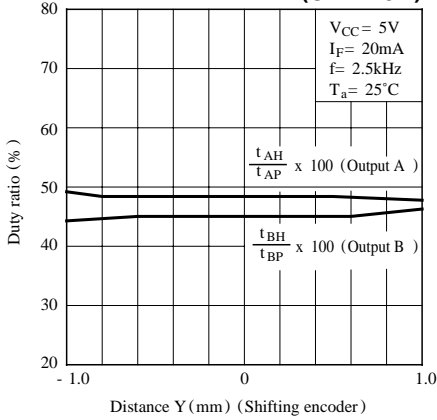

Fig. 9-b Duty Ratio vs. Distance (Y direction) (GP1A71R)

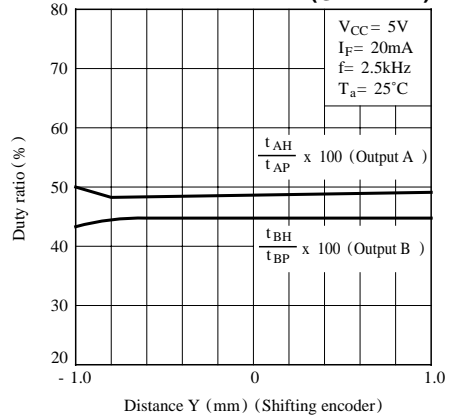

Fig.10-a Phase Difference vs. Distance (Y direction) (GP1A70R)

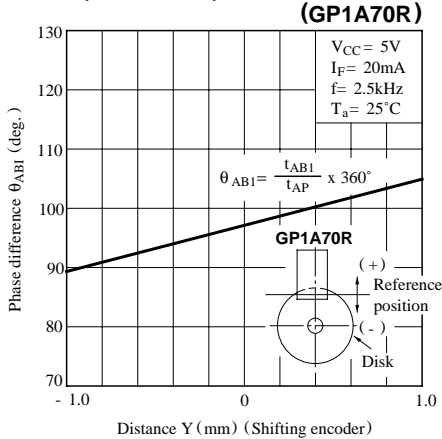

Fig.10-b Phase Difference vs. Distance (Y direction) (GP1A71R)

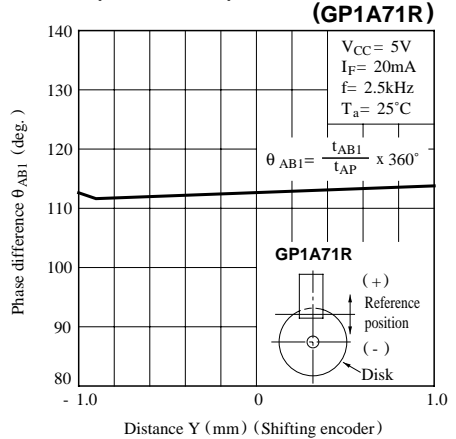

Fig.11-a Duty Ratio vs. Distance (Z direction) (GP1A70R)

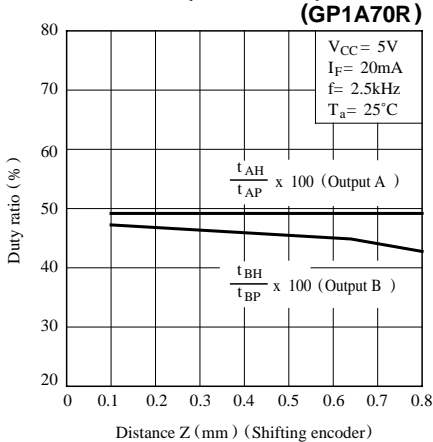

Fig.11-b Duty Ratio vs. Distance (Z direction) (GP1A71R)

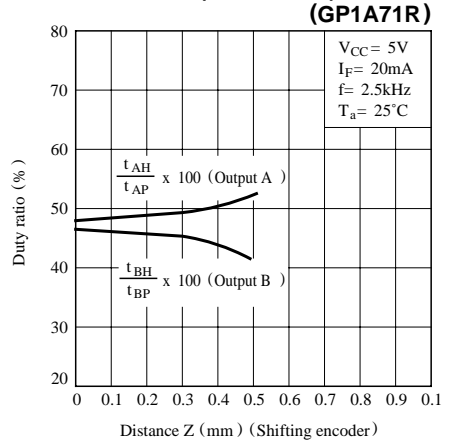

Fig.12-a Phase Difference vs. Distance
(Z direction)

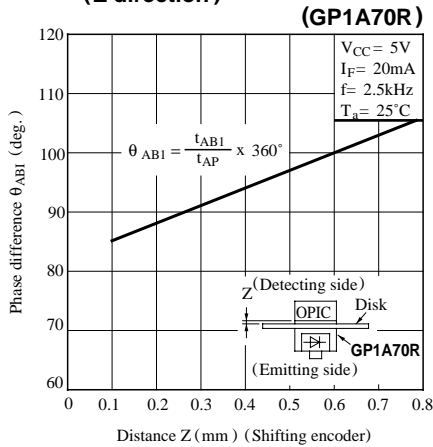
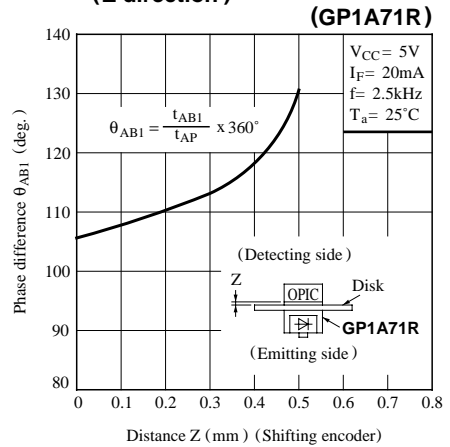
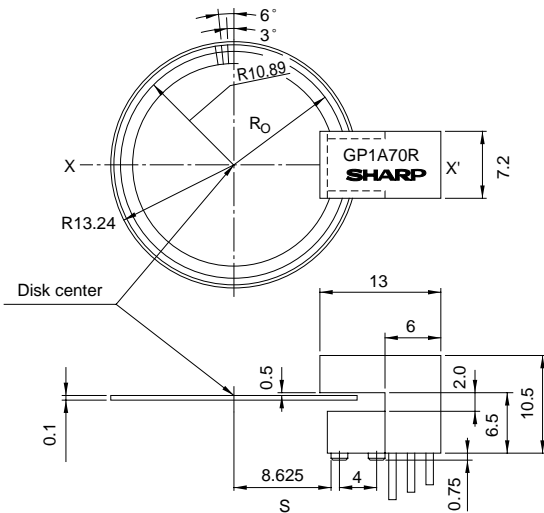

Fig.12-b Phase Difference vs. Distance
(Z direction)



<Measurement Conditions> (Unit : mm)



<GP1A70R Basic Design>

R_0 (distance between the disk center and half point of a slit) and S (installing position of GP1A70R) will be provided by the following equations.

$$R_0 = N/60 \times 10.89 \text{ (mm)} \quad N: \text{ number of slits}$$

$$S = R_0 - 2.265 \text{ (mm)}$$

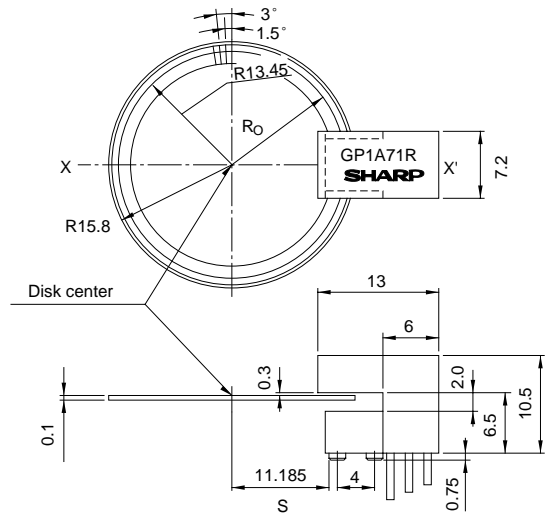

<GP1A71R Basic Design>

R_0 (distance between the disk center and half point of a slit) and S (installing position of GP1A71R) will be provided by the following equations.

$$R_0 = N/120 \times 13.45 \text{ (mm)} \quad N: \text{ number of slits}$$

$$S = R_0 - 2.265 \text{ (mm)}$$

■ Precautions for Use

- (1) This device is designed to be used under the condition of $I_F = 20mA$
- (2) It is recommended that a by-pass capacitor of more than $0.01\mu F$ be added between V_{CC} and GND near the device in order to stabilize power supply line.
- (3) As for other general cautions, refer to the chapter "Precautions for Use".