

GP1L57

Wide Gap Type Photointerrupter

■ Features

1. Wide gap between emitter and detector (Gap width : 10 mm)
2. Deep groove type (Depth : 12.2 mm)
3. With positioning pin
4. PWB direct mounting type package

■ Applications

1. Analytical equipment, measuring instruments
2. Amusement equipment
3. Optoelectronic switches, optoelectronic counters

■ Outline Dimensions

(Unit : mm)

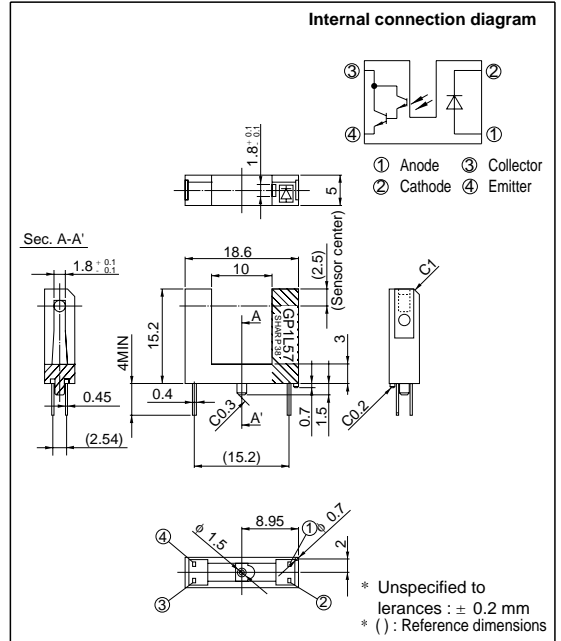

■ Absolute Maximum Ratings

(Ta=25°C)

Parameter		Symbol	Rating	Unit
Input	Forward current	I_F	50	mA
	*1 Peak forward current	I_{FM}	1	A
	Reverse voltage	V_R	6	V
	Power dissipation	P	75	mW
Output	Collector-emitter voltage	V_{CEO}	35	V
	Emitter-collector voltage	V_{ECO}	6	V
	Collector current	I_C	40	mA
	Collector power dissipation	P_C	75	mW
Operating temperature		T_{opr}	- 25 to + 85	°C
Storage temperature		T_{stg}	- 40 to + 100	°C
*2 Soldering temperature		T_{sol}	260	°C

*1 Pulse width $\leq 100\mu$ s, Duty ratio=0.01

*2 For 5 seconds

■ Electro-optical Characteristics

(Ta=25 °C)

Parameter		Symbol	Conditions	MIN.	TYP.	MAX.	Unit
Input	Forward voltage	V_F	$I_F = 20\text{mA}$	-	1.25	1.4	V
	Peak forward voltage	V_{FM}	$I_{FM} = 0.5\text{A}$	-	3	4	V
	Reverse current	I_R	$V_R = 3\text{V}$	-	-	10	μA
Output	Dark current	I_{CEO}	$V_{CE} = 10\text{V}$	-	-	10^{-6}	A
Transfer characteristics	Collector current	I_C	$I_F = 1\text{mA}, V_{CE} = 2\text{V}$	0.7	-	28	mA
	Collector-emitter saturation voltage	$V_{CE(sat)}$	$I_F = 4\text{mA}, I_C = 0.6\text{mA}$	-	-	1	V
	Response time	Rise time	t_r	$V_{CE} = 2\text{V}, I_C = 2\text{mA}$	-	130	400
Fall time		t_f	$R_L = 100\ \Omega$	-	100	350	μs

Fig. 1 Forward Current vs. Ambient Temperature

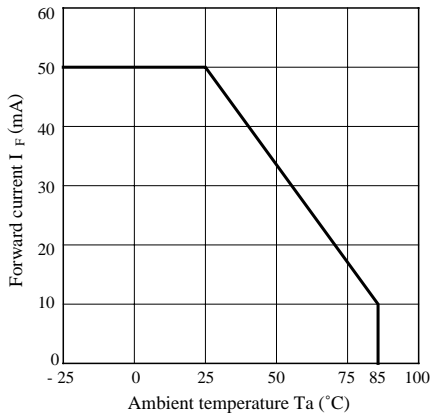

Fig. 2 Collector power Dissipation vs. Ambient Temperature

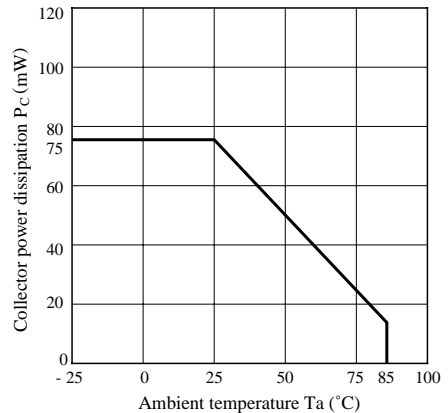

Fig. 3 Peak Forward Current vs. Duty Ratio

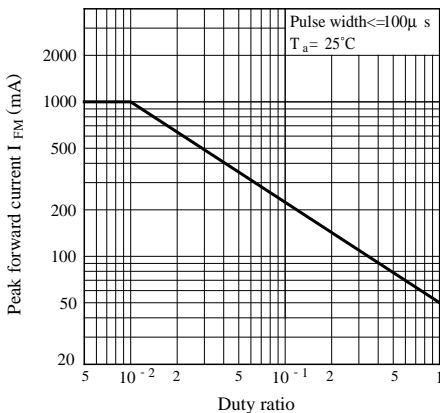

Fig. 4 Forward Current vs. Forward Voltage

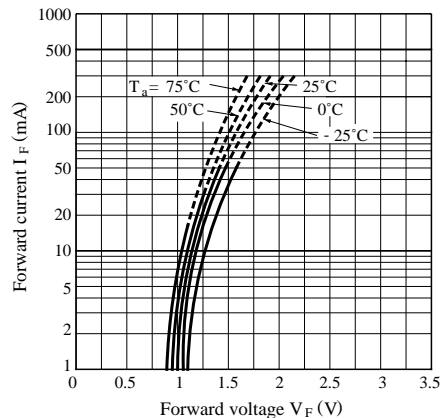

Fig. 5 Collector Current vs. Forward Current

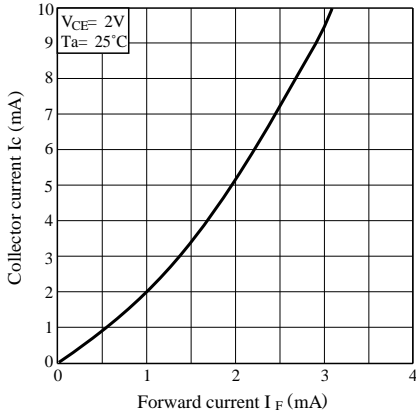

Fig. 6 Collector Current vs. Collector-emitter Voltage

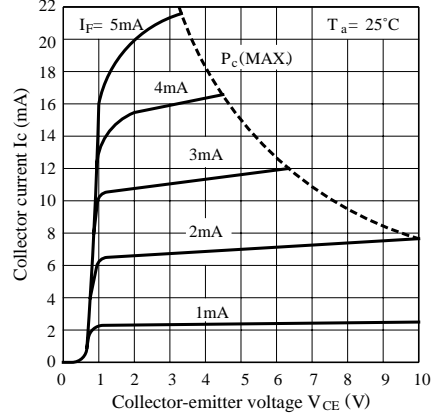

Fig. 7 Collector Current vs. Ambient temperature

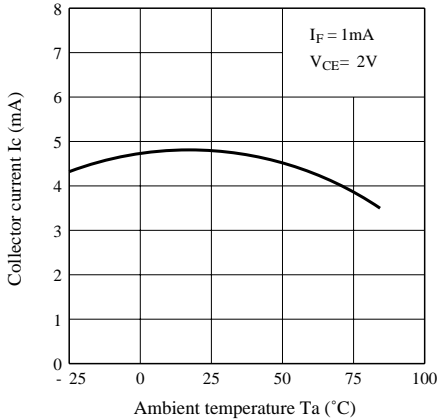

Fig. 8 Collector-emitter Saturation Voltage vs. Ambient Temperature

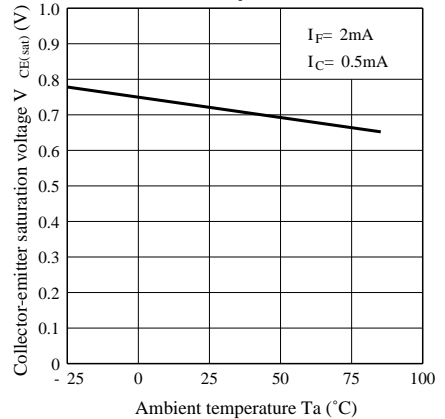
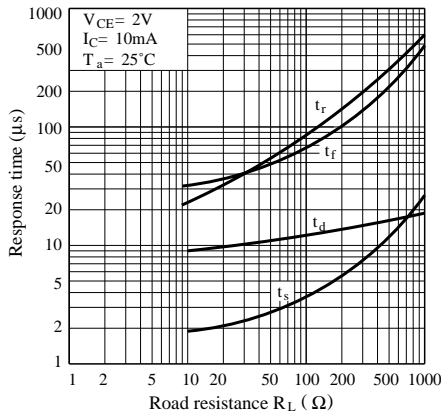

Fig. 9 Response Time vs. Load Resistance



Test Circuit for Response Time

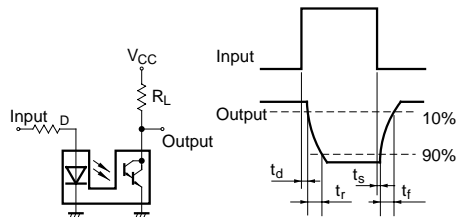

Fig. 10 Frequency characteristics

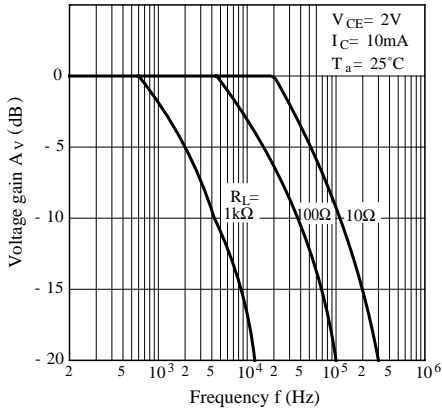

Fig. 11 Dark Current vs. Ambient Temperature

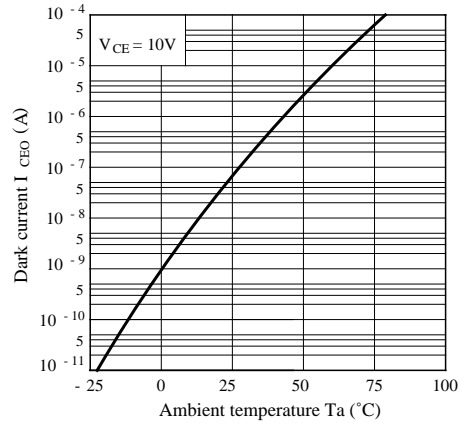

Fig. 12 Detecting Position Characteristics (1)

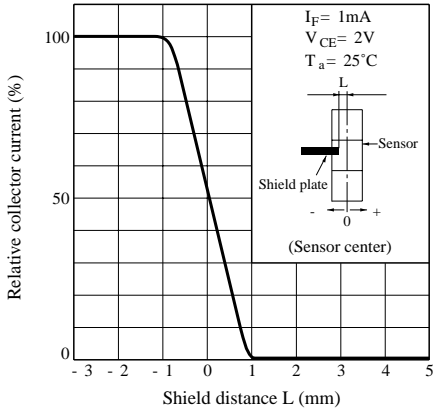
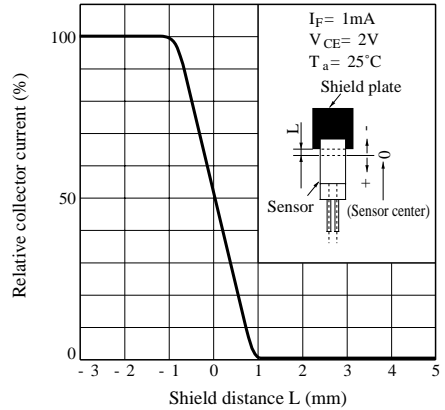

Fig. 13 Detecting Position Characteristics (2)



(Precautions for Operation)

In case of cleaning, use only the following type of cleaning solvent.

Ethyl alcohol, Methyl alcohol, Isopropyl alcohol

- As for other general precautions, please refer to the chapter "Precautions for Use".