

GP1S23

Subminiature Photointerrupter

■ Features

1. Ultra-compact
2. PWB mounting type package
3. High sensing accuracy (Slit width: 0.3mm)
4. Gap between light emitter and detector: 2mm

■ Applications

1. Cameras
2. Floppy disk drives

■ Outline Dimensions

(Unit : mm)

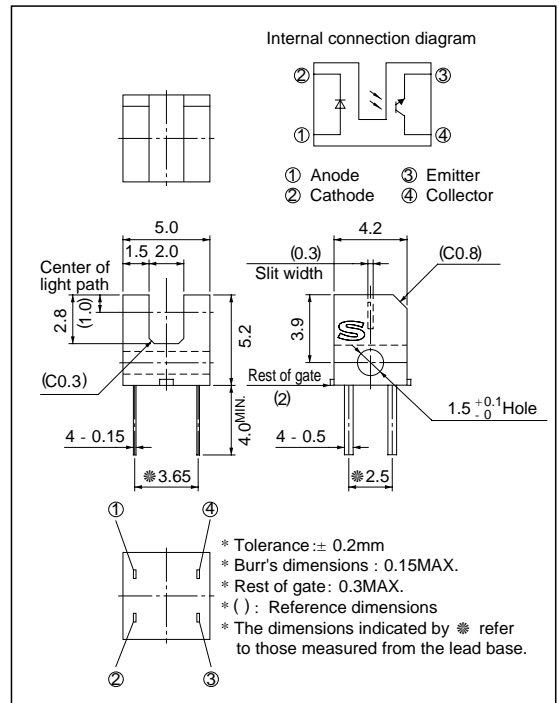

■ Absolute Maximum Ratings

($T_a = 25^\circ\text{C}$)

Parameter		Symbol	Rating	Unit
Input	Forward current	I_F	50	mA
	Reverse voltage	V_R	6	V
	Power dissipation	P	75	mW
Output	Collector-emitter voltage	V_{CEO}	35	V
	Emitter-collector voltage	V_{ECO}	6	V
	Collector current	I_C	20	mA
	Collector power dissipation	P_C	75	mW
Total power dissipation		P_{tot}	100	mW
Operating temperature		T_{opr}	- 25 to + 85	$^\circ\text{C}$
Storage temperature		T_{stg}	- 40 to + 100	$^\circ\text{C}$
*1 Soldering temperature		T_{sol}	260	$^\circ\text{C}$

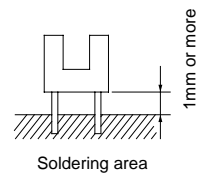

*1 For 3 seconds

Electro-optical Characteristics

($T_a = 25^\circ\text{C}$)

Parameter		Symbol	Conditions	MIN.	TYP.	MAX.	Unit
Input	Forward voltage	V_F	$I_F = 20\text{mA}$	-	1.2	1.4	V
	Reverse current	I_R	$V_R = 3\text{V}$	-	-	10	μA
Output	Collector dark current	I_{CEO}	$V_{CE} = 20\text{V}$	-	-	1×10^{-7}	A
Transfer-characteristics	Collector Current	I_C	$I_F = 5\text{mA}, V_{CE} = 5\text{V}$	40	-	400	μA
	Collector-emitter saturation voltage	$V_{CE(sat)}$	$I_F = 10\text{mA}, I_C = 40\mu\text{A}$	-	-	0.4	V
	Response time	Rise time	t_r	$I_C = 0.1\text{mA}, V_{CE} = 5\text{V}, R_L = 1\text{k}\Omega$	-	50	150
Fall time		t_f	-		50	150	μs

Fig. 1 Forward Current vs. Ambient Temperature

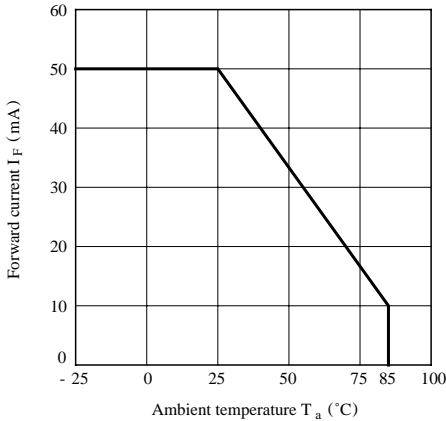

Fig. 2 Power Dissipation vs. Ambient Temperature

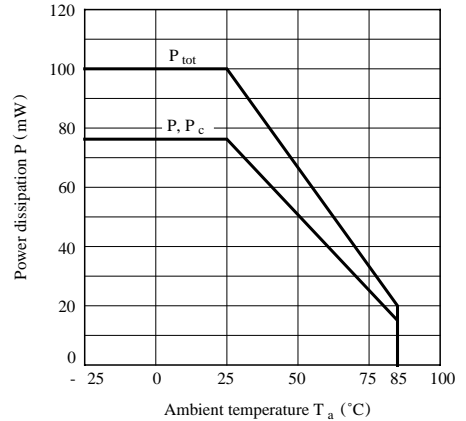

Fig. 3 Forward Current vs. Forward Voltage

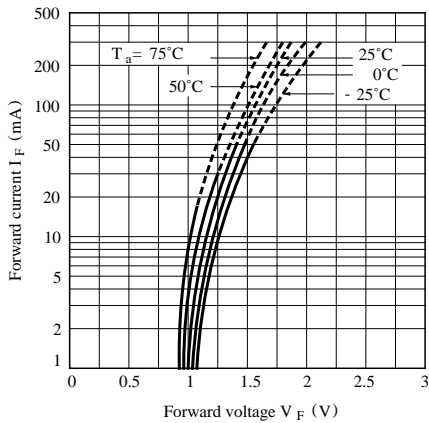

Fig. 4 Collector Current vs. Forward Current

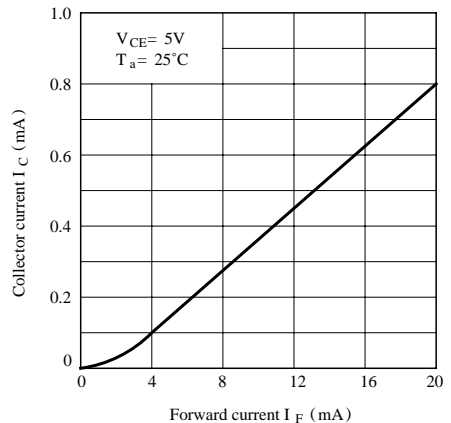

Fig. 5 Collector Current vs. Collector-emitter voltage

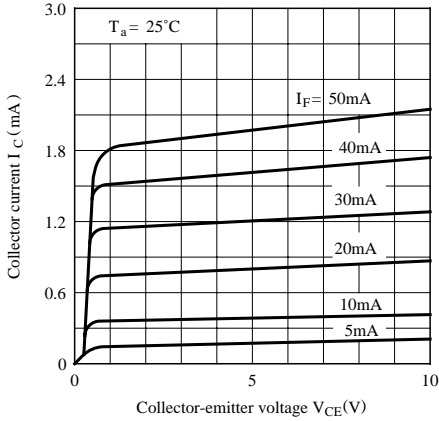

Fig. 6 Collector Current vs. Ambient Temperature

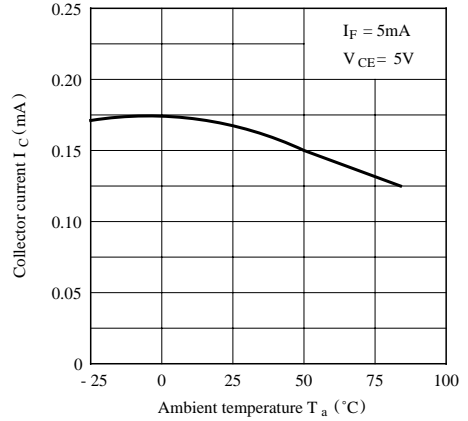

Fig. 7 Collector-emitter Saturation Voltage vs. Ambient Temperature

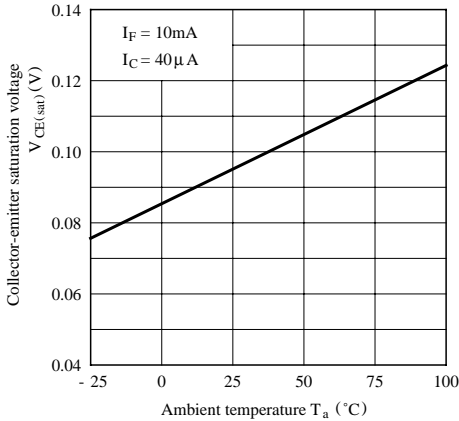

Fig. 8 Collector Dark Current vs. Ambient Temperature

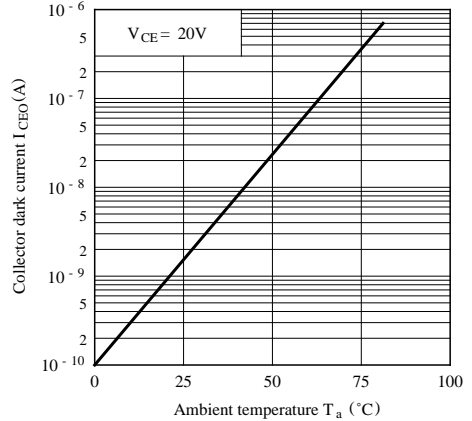
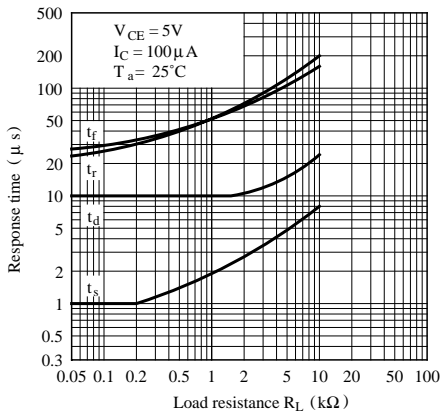

Fig. 9 Response Time vs. Load Resistance



Test Circuit for Response Time

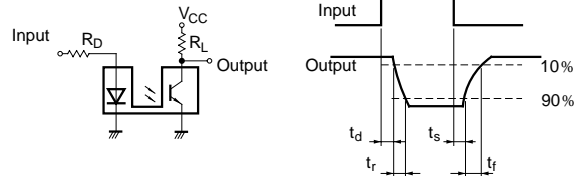

Fig.10 Relative Collector Current vs. Shield Distance (1)

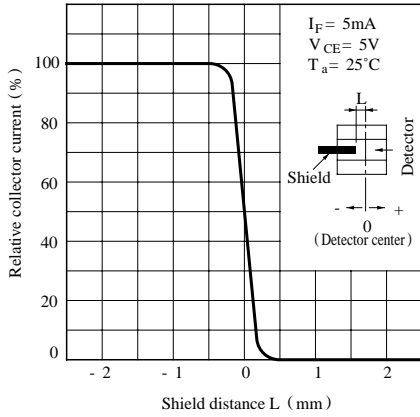
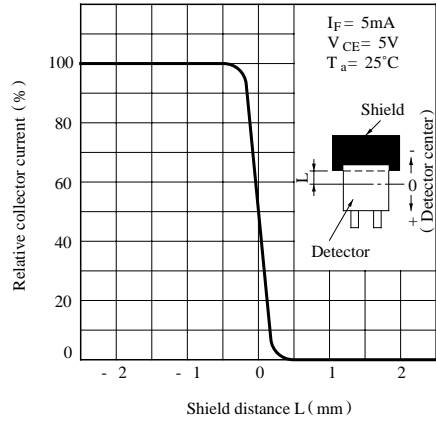

Fig.11 Relative Collector Current vs. Shield Distance (2)



- Please refer to the chapter “Precautions for Use”.