

The GP2400ESM12 is a single switch 1200V, robust n channel enhancement mode insulated gate bipolar transistor (IGBT) module. Designed for low power loss, the module is suitable for a variety of high voltage applications in motor drives and power conversion. The high impedance gate simplifies gate drive considerations enabling operation directly from low power control circuitry.

Fast switching times allow high frequency operation making the device suitable for the latest drive designs employing pwm and high frequency switching. The IGBT has a wide reverse bias safe operating area (RBSOA) for ultimate reliability in demanding applications.

These modules incorporate electrically isolated base plates and low inductance construction enabling circuit designers to optimise circuit layouts and utilise grounded heat sinks for safety.

The powerline range of high power modules includes dual and single switch configurations with a range of current and voltage capabilities to match customer system demands.

This device is optimised for traction drives and other applications requiring high thermal cycling capability.

KEY PARAMETERS

V_{CES}		1200V
$V_{CE(sat)}$	(typ)	2.7V
I_C	(max)	2400A
$I_{C(PK)}$	(max)	4800A

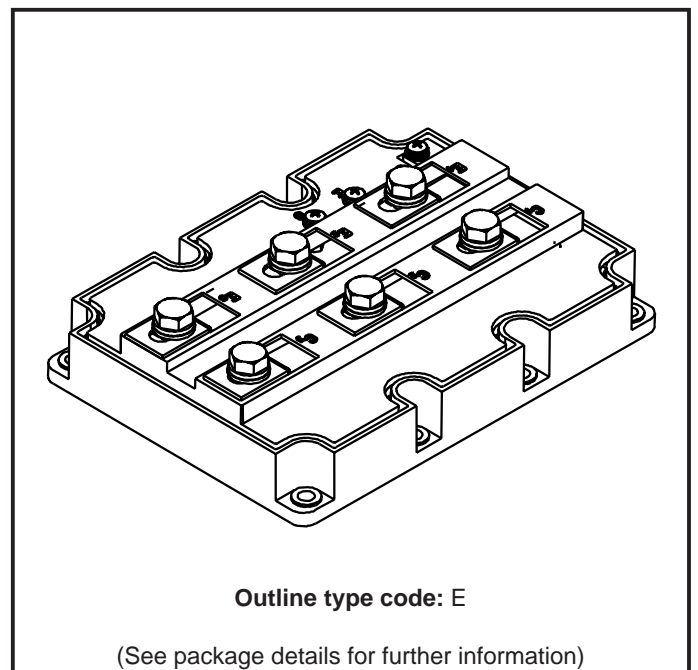

Fig. 1 Electrical connections - (not to scale)

FEATURES

- n - Channel Enhancement Mode
- Non Punch Through Silicon
- High Gate Input Impedance
- Optimised For High Power High Frequency Operation
- Isolated MMC Base with AlN
- 1200V Rating
- 2400A Per Module

APPLICATIONS

- High Power Switching
- Motor Control
- Inverters
- Traction Drives

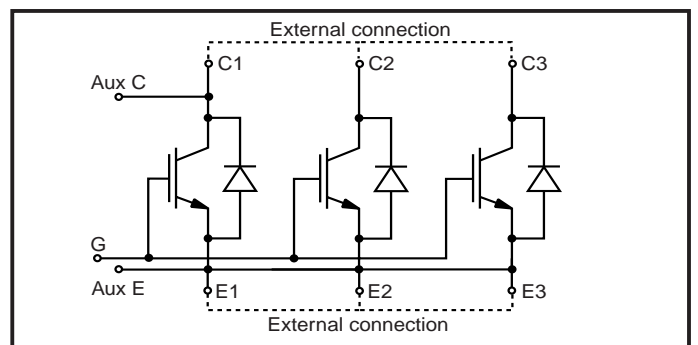

Fig.2 Single switch circuit diagram

ORDERING INFORMATION

Order As: **GP2400ESM12**

Note: When ordering, please use the whole part number.

Caution: This device is sensitive to electrostatic discharge. Users should follow ESD handling procedures.

GP2400ESM12

ABSOLUTE MAXIMUM RATINGS

Stresses above those listed under 'Absolute Maximum Ratings' may cause permanent damage to the device. This is a stress rating only and functional operation of the device at these or any other conditions above those indicated in the operational sections of this specification is not implied. Exposure to Absolute Maximum Ratings for extended periods may affect device reliability.

$T_{case} = 25^{\circ}\text{C}$ unless stated otherwise.

Symbol	Parameter	Test Conditions	Max.	Units
V_{CES}	Collector-emitter voltage	$V_{GE} = 0V$	1200	V
V_{GES}	Gate-emitter voltage	-	± 20	V
I_C	Continuous collector current	DC, $T_{case} = 75^{\circ}\text{C}$, $T_j = 125^{\circ}\text{C}$	2400	A
$I_{C(PK)}$	Peak collector current	1ms, $T_{case} = 75^{\circ}\text{C}$, $T_j = 125^{\circ}\text{C}$	4800	A
P_{max}	Max. power dissipation	$T_{case} = 25^{\circ}\text{C}$ (Transistor), $T_j = 150^{\circ}\text{C}$	20.8	kW
V_{isol}	Isolation voltage	Commoned terminals to base plate. AC RMS, 1 min, 50Hz	2500	V

THERMAL AND MECHANICAL RATINGS

Symbol	Parameter	Test Conditions	Min.	Max.	Units
$R_{th(j-c)}$	Thermal resistance - transistor	DC junction to case	-	6	$^{\circ}\text{C}/\text{kW}$
$R_{th(j-d)}$	Thermal resistance - diode	DC junction to case	-	13.3	$^{\circ}\text{C}/\text{kW}$
$R_{th(c-h)}$	Thermal resistance - case to heatsink (per module)	Mounting torque 5Nm (with mounting grease)	-	6	$^{\circ}\text{C}/\text{kW}$
T_j	Junction temperature	Transistor	-	150	$^{\circ}\text{C}$
		Diode	-	125	$^{\circ}\text{C}$
T_{stg}	Storage temperature range	-	-40	125	$^{\circ}\text{C}$
-	Screw torque	Mounting - M6	-	5	Nm
		Electrical connections - M4	-	2	Nm
		Electrical connections - M8	-	10	Nm

Caution: This device is sensitive to electrostatic discharge. Users should follow ESD handling procedures.

ELECTRICAL CHARACTERISTICS

$T_{case} = 25^{\circ}\text{C}$ unless stated otherwise.

Symbol	Parameter	Test Conditions	Min.	Typ.	Max.	Units
I_{CES}	Collector cut-off current	$V_{GE} = 0\text{V}, V_{CE} = V_{CES}$	-	-	3	mA
		$V_{GE} = 0\text{V}, V_{CE} = V_{CES}, T_{case} = 125^{\circ}\text{C}$	-	-	100	mA
I_{GES}	Gate leakage current	$V_{GE} = \pm 20\text{V}, V_{CE} = 0\text{V}$	-	-	12	μA
$V_{GE(TH)}$	Gate threshold voltage	$I_C = 120\text{mA}, V_{GE} = V_{CE}$	4	-	7.5	V
$V_{CE(sat)}$	Collector-emitter saturation voltage	$V_{GE} = 15\text{V}, I_C = 2400\text{A}$	-	2.7	3.5	V
		$V_{GE} = 15\text{V}, I_C = 2400\text{A}, T_{case} = 125^{\circ}\text{C}$	-	3.2	4.0	V
I_F	Diode forward current	DC, $T_{case} = 50^{\circ}\text{C}, T_j = 125^{\circ}\text{C}$	-	-	2400	A
I_{FM}	Diode maximum forward current	$t_p = 1\text{ms}, T_j = 125^{\circ}\text{C}$	-	-	4800	A
V_F	Diode forward voltage	$I_F = 2400\text{A}$	-	2.2	2.4	V
		$I_F = 2400\text{A}, T_{case} = 125^{\circ}\text{C}$	-	2.3	2.5	V
C_{ies}	Input capacitance	$V_{CE} = 25\text{V}, V_{GE} = 0\text{V}, f = 1\text{MHz}$	-	270	-	nF
L_M	Module inductance	-	-	10	-	nH

Caution: This device is sensitive to electrostatic discharge. Users should follow ESD handling procedures.

GP2400ESM12

ELECTRICAL CHARACTERISTICS

For definition of switching waveforms, refer to figure 3 and 4.

$T_{\text{case}} = 25^{\circ}\text{C}$ unless stated otherwise.

Symbol	Parameter	Test Conditions	Min.	Typ.	Max.	Units
$t_{\text{d(off)}}$	Turn-off delay time	$I_{\text{C}} = 2400\text{A}$	-	2300	-	ns
t_{f}	Fall time	$V_{\text{GE}} = \pm 15\text{V}$	-	400	-	ns
E_{OFF}	Turn-off energy loss	$V_{\text{CE}} = 600\text{V}$	-	820	-	mJ
$t_{\text{d(on)}}$	Turn-on delay time	$R_{\text{G(ON)}} = R_{\text{G(OFF)}} = 3.3\Omega$	-	2600	-	ns
t_{r}	Rise time	$L \sim 80\text{nH}$	-	1100	-	ns
E_{ON}	Turn-on energy loss		-	490	-	mJ
Q_{rr}	Diode reverse recovery charge	$I_{\text{F}} = 2400\text{A}, V_{\text{R}} = 50\% V_{\text{CES}}$ $di_{\text{F}}/dt = 2000\text{A}/\mu\text{s}$	-	200	-	μC

$T_{\text{case}} = 125^{\circ}\text{C}$ unless stated otherwise.

Symbol	Parameter	Test Conditions	Min.	Typ.	Max.	Units
$t_{\text{d(off)}}$	Turn-off delay time	$I_{\text{C}} = 2400\text{A}$	-	2570	-	ns
t_{f}	Fall time	$V_{\text{GE}} = \pm 15\text{V}$	-	400	-	ns
E_{OFF}	Turn-off energy loss	$V_{\text{CE}} = 600\text{V}$	-	980	-	mJ
$t_{\text{d(on)}}$	Turn-on delay time	$R_{\text{G(ON)}} = R_{\text{G(OFF)}} = 3.3\Omega$	-	2650	-	ns
t_{r}	Rise time	$L \sim 80\text{nH}$	-	1000	-	ns
E_{ON}	Turn-on energy loss		-	620	-	mJ
Q_{rr}	Diode reverse recovery charge	$I_{\text{F}} = 2400\text{A}, V_{\text{R}} = 50\% V_{\text{CES}}$ $di_{\text{F}}/dt = 2000\text{A}/\mu\text{s}$	-	400	-	μC

Caution: This device is sensitive to electrostatic discharge. Users should follow ESD handling procedures.

SWITCHING DEFINITIONS

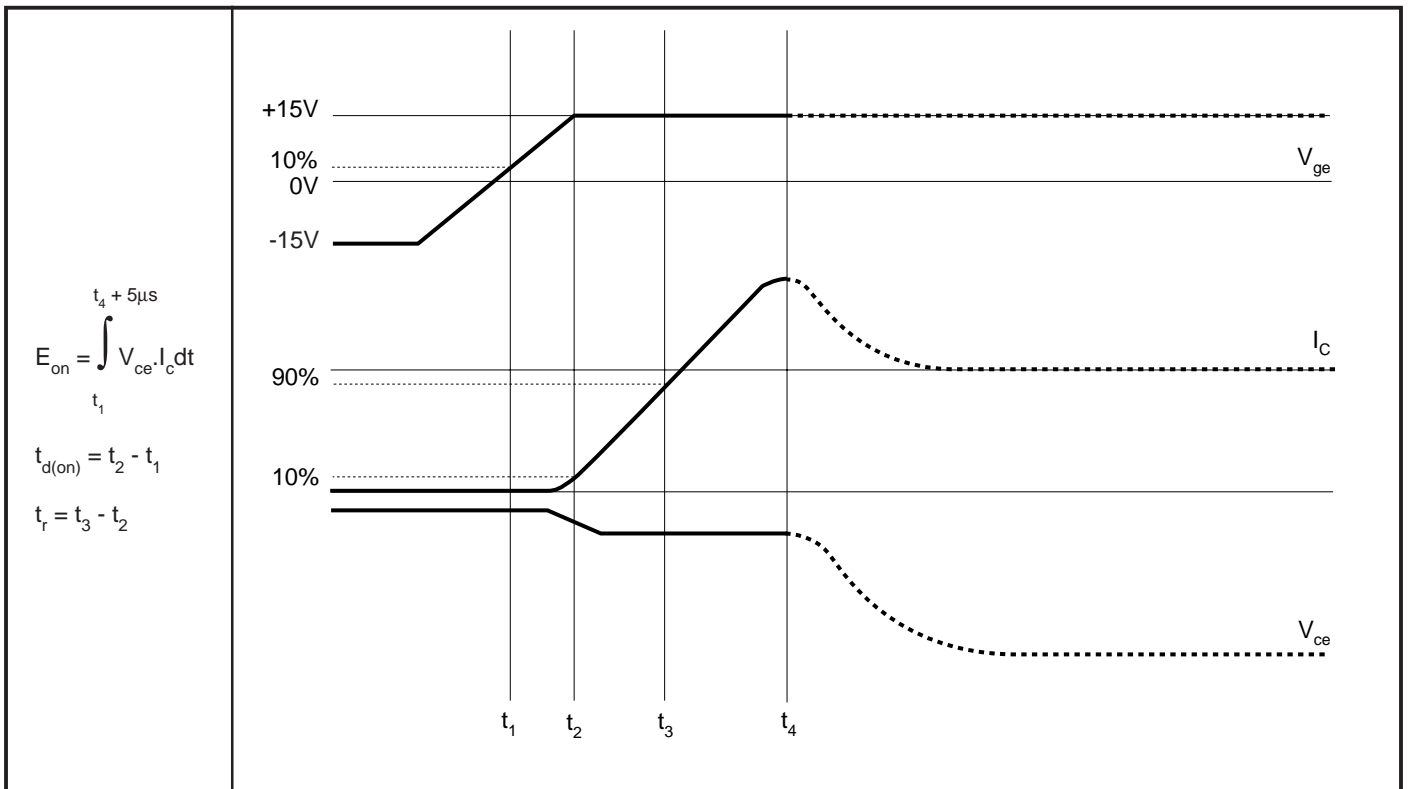

Fig.3 Definition of turn-on switching times

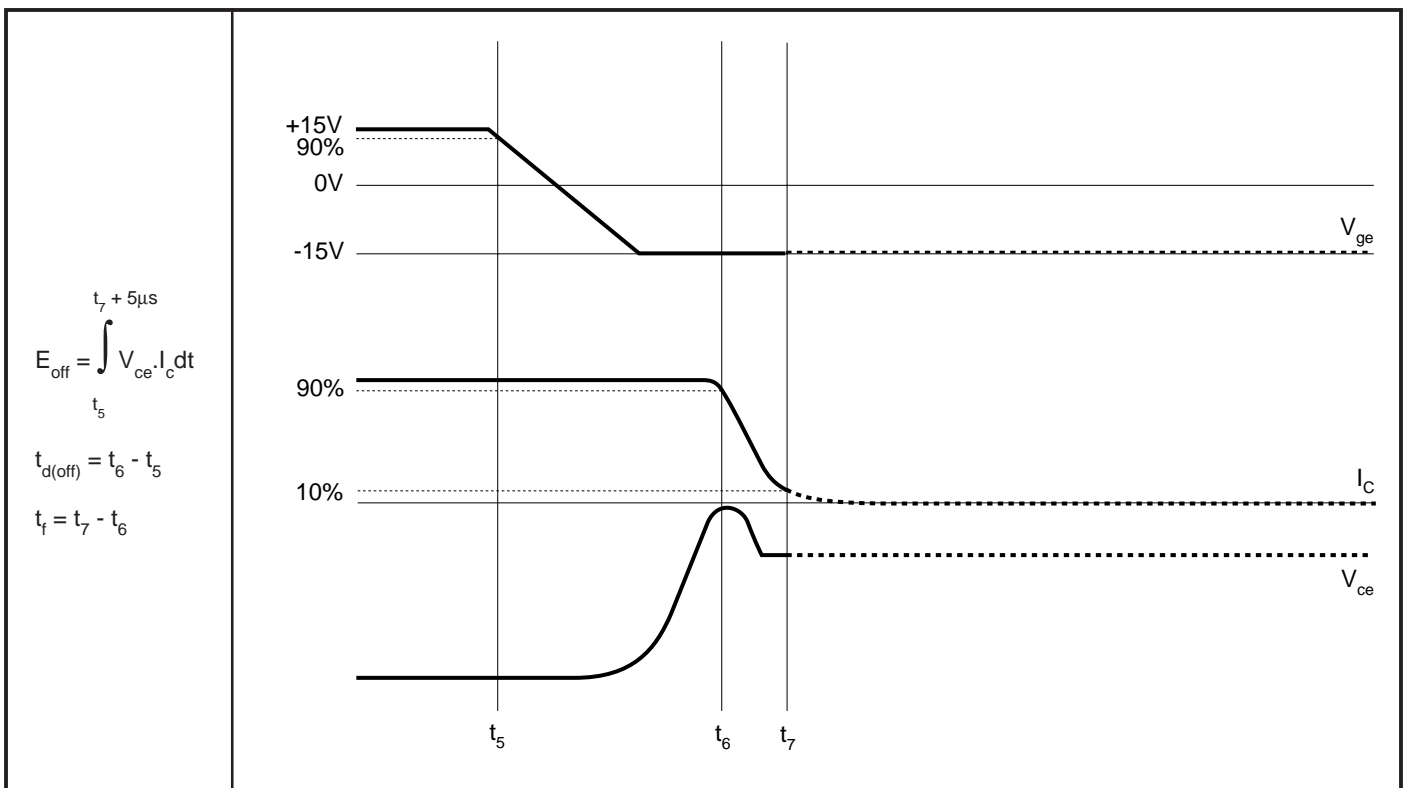

Fig.4 Definition of turn-off switching times

Caution: This device is sensitive to electrostatic discharge. Users should follow ESD handling procedures.

TYPICAL CHARACTERISTICS

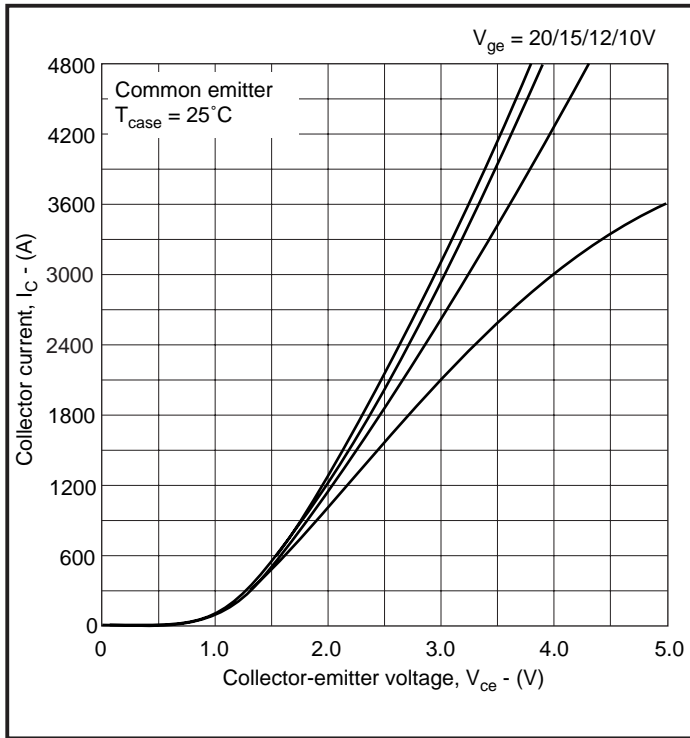

Fig.5 Typical output characteristics

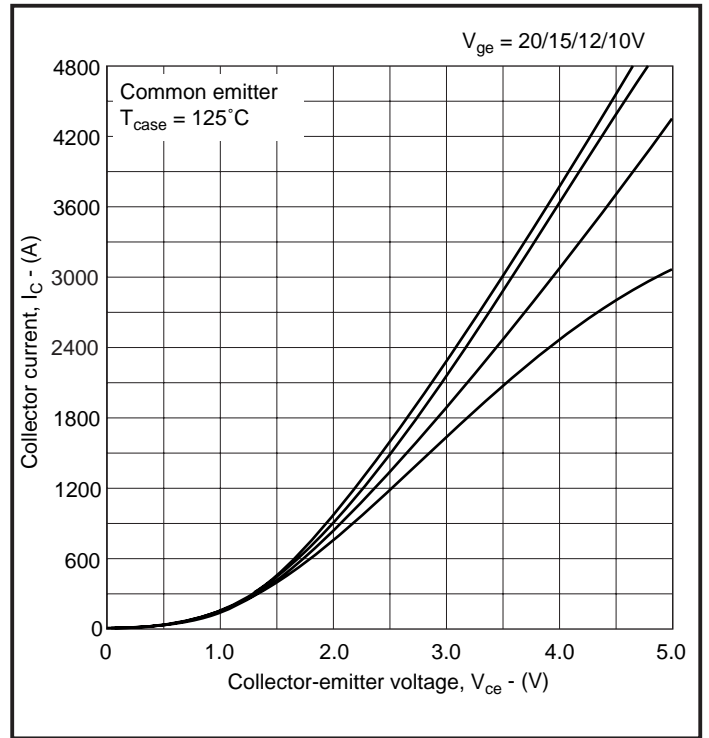

Fig.6 Typical output characteristics

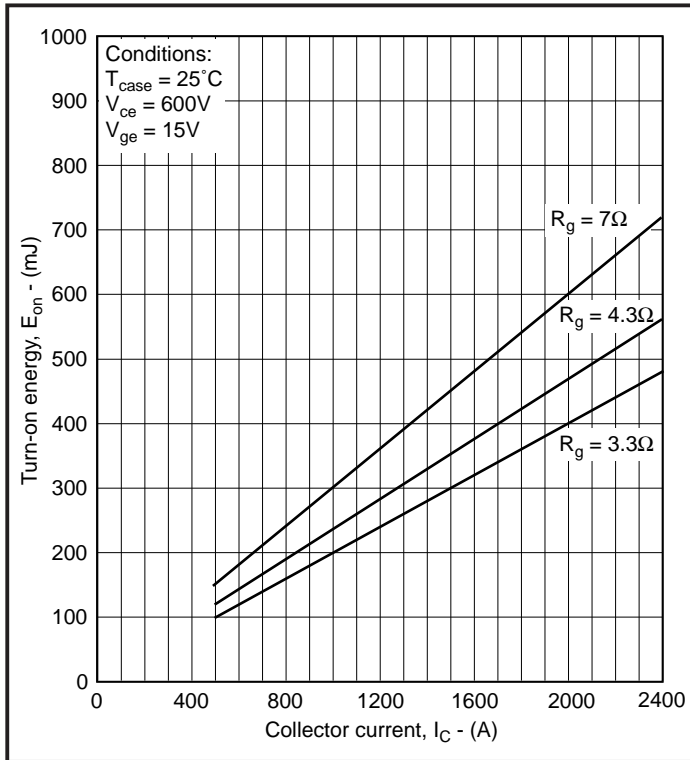

Fig.7 Typical turn-on energy vs collector current

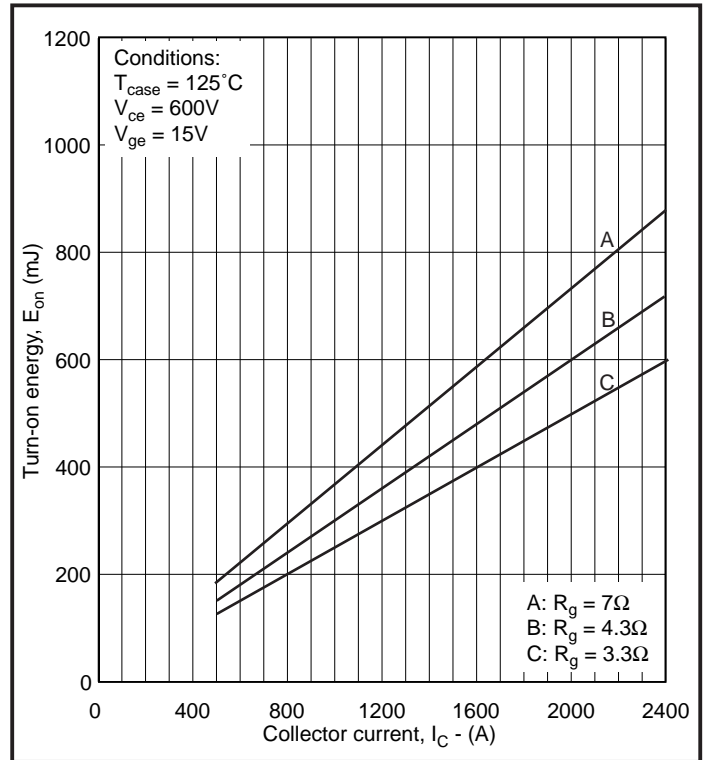

Fig.8 Typical turn-on energy vs collector current

Caution: This device is sensitive to electrostatic discharge. Users should follow ESD handling procedures.

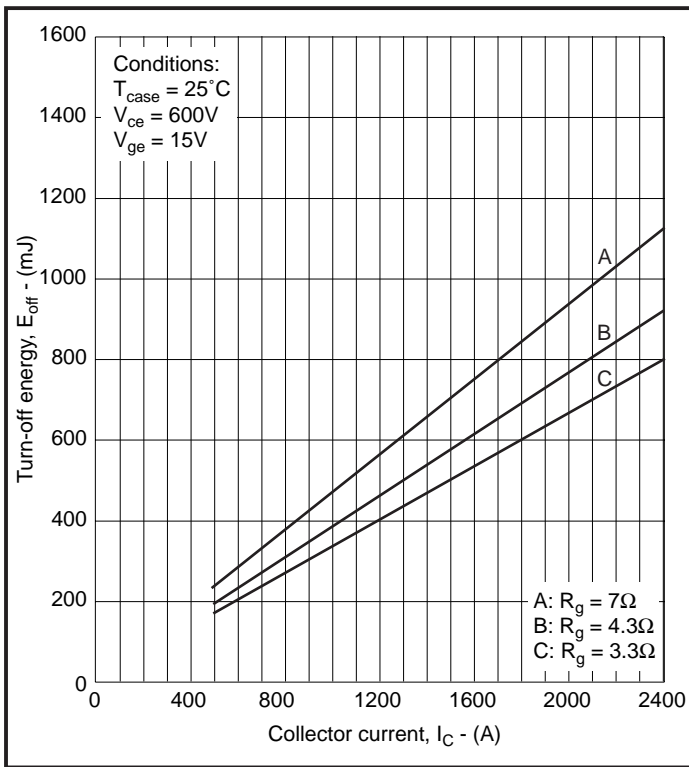

Fig.9 Typical turn-off energy vs collector current

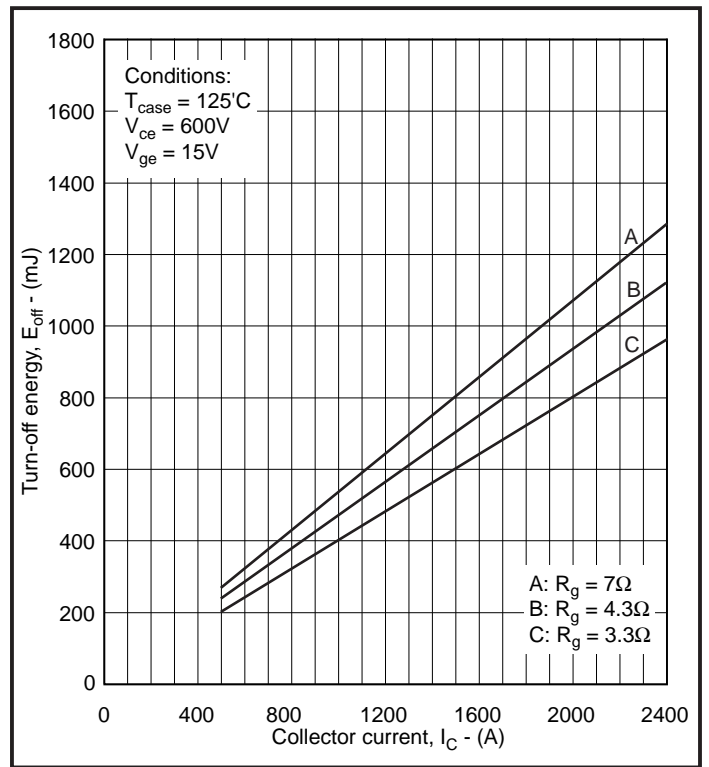

Fig.10 Typical turn-off energy vs collector current

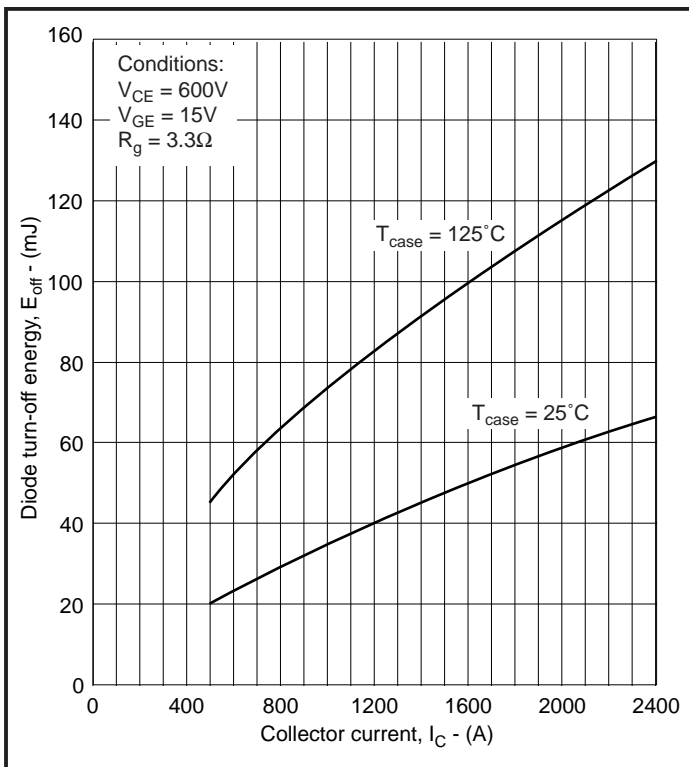

Fig.11 Typical diode reverse recovery charge vs collector current

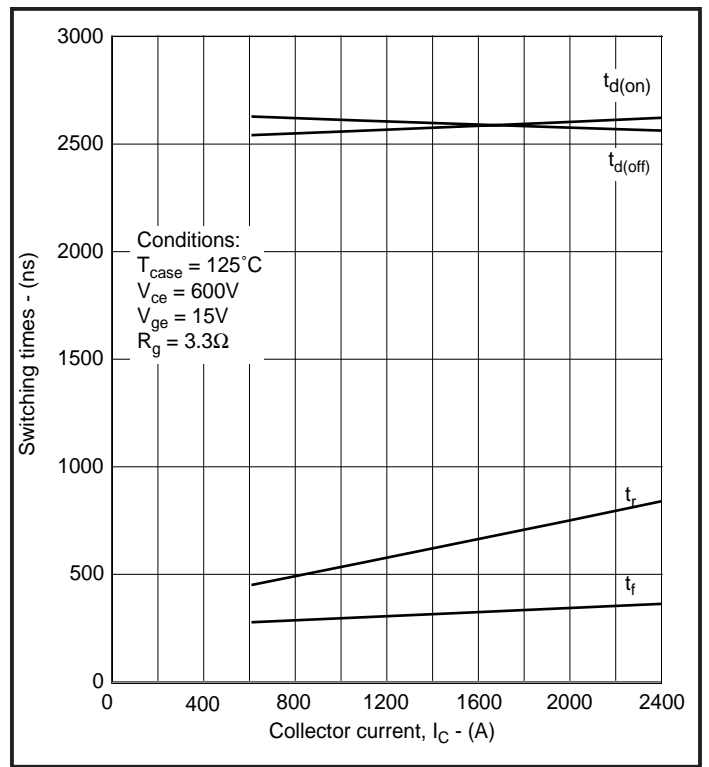

Fig.12 Typical switching characteristics

Caution: This device is sensitive to electrostatic discharge. Users should follow ESD handling procedures.

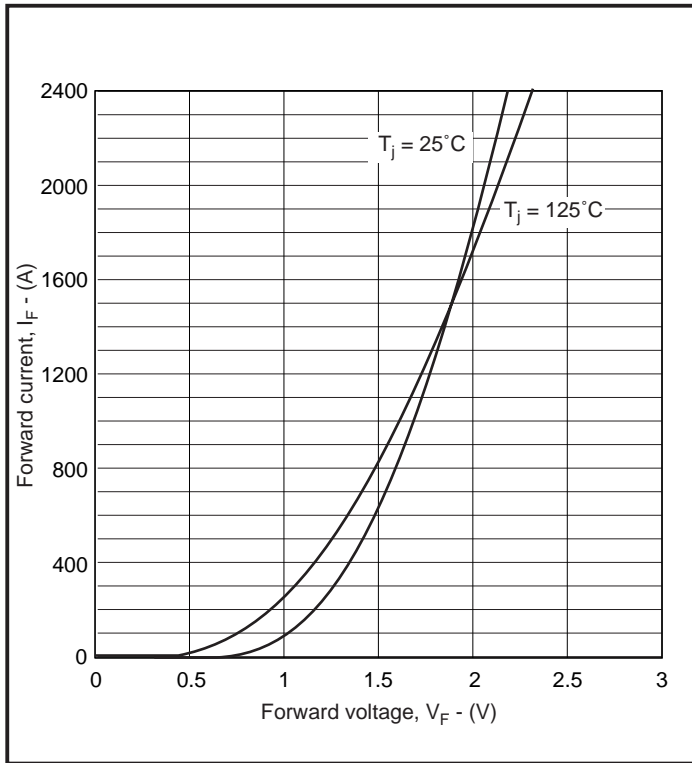

Fig.13 Diode typical forward characteristics

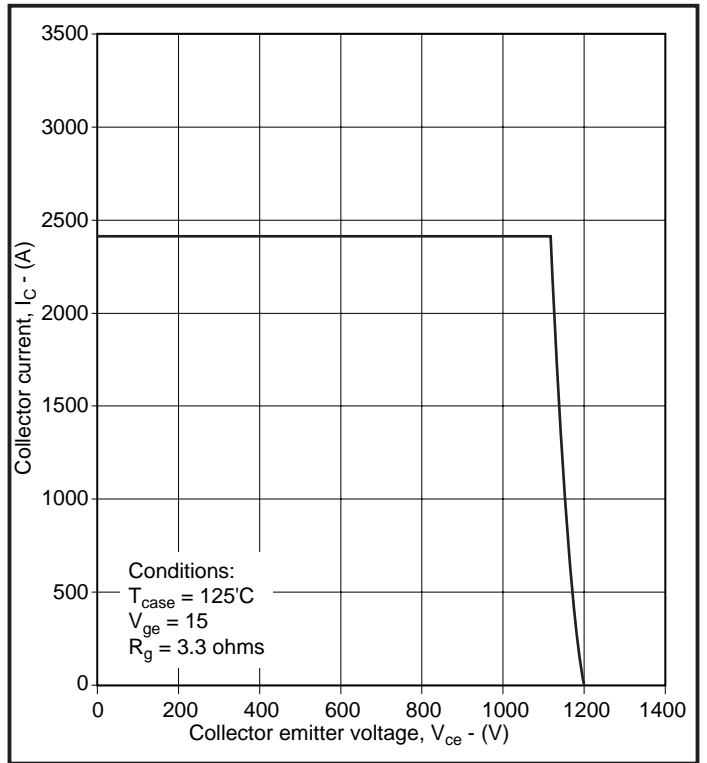

Fig.14 Reverse bias safe operating area

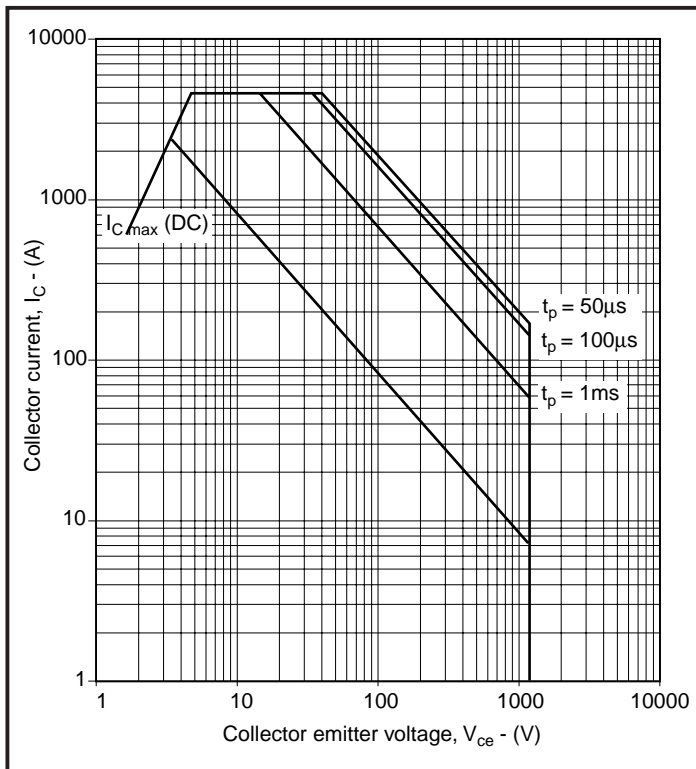

Fig.15 Forward bias safe operating area

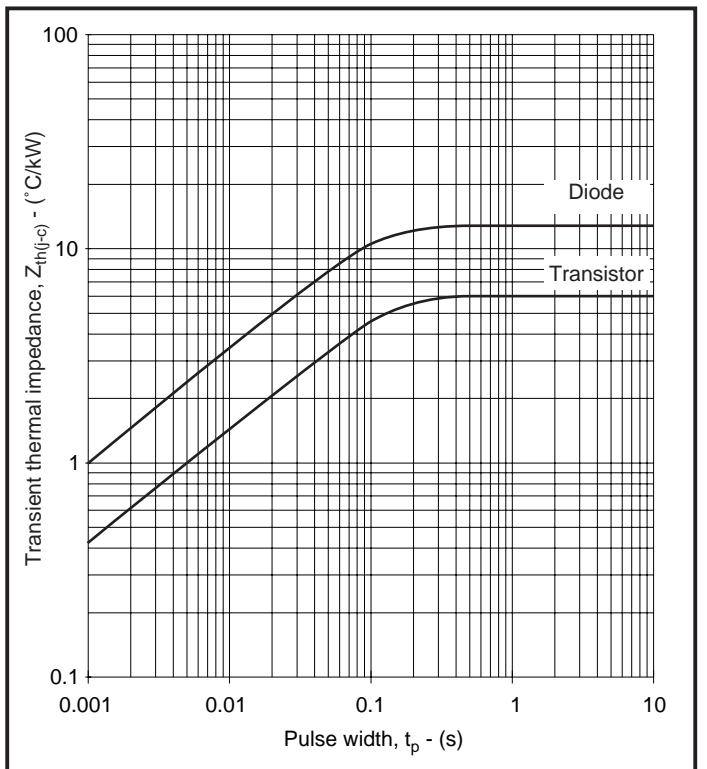

Fig.16 Transient thermal impedance

Caution: This device is sensitive to electrostatic discharge. Users should follow ESD handling procedures.

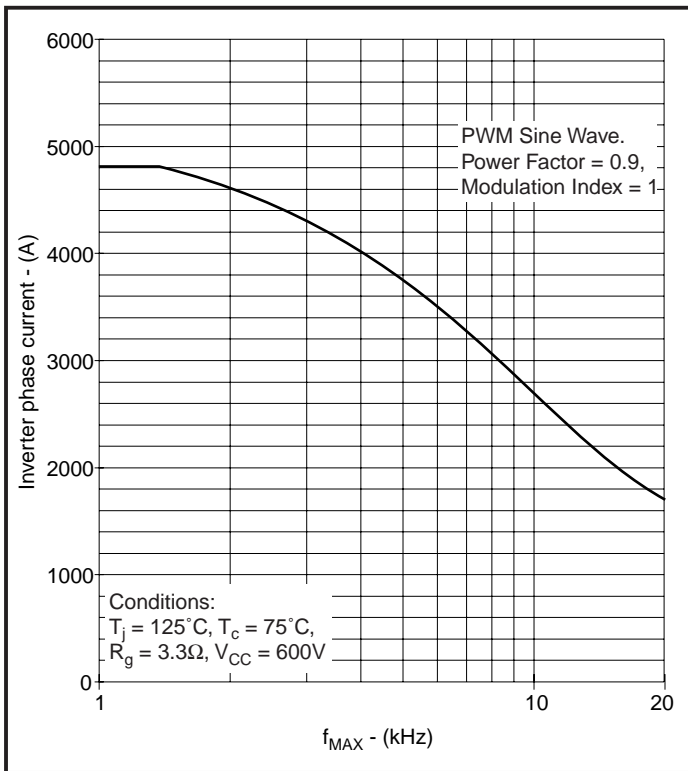

Fig.18 3-Phase inverter operating frequency

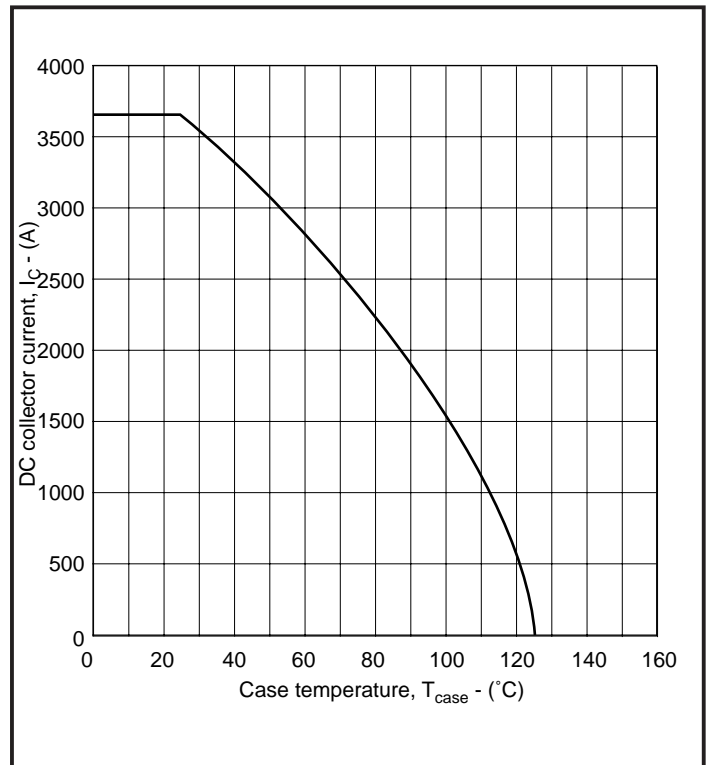

Fig.19 DC current rating vs case temperature

Caution: This device is sensitive to electrostatic discharge. Users should follow ESD handling procedures.

GP2400ESM12

PACKAGE DETAILS

For further package information, please contact your local Customer Service Centre. All dimensions in mm, unless stated otherwise. DO NOT SCALE.

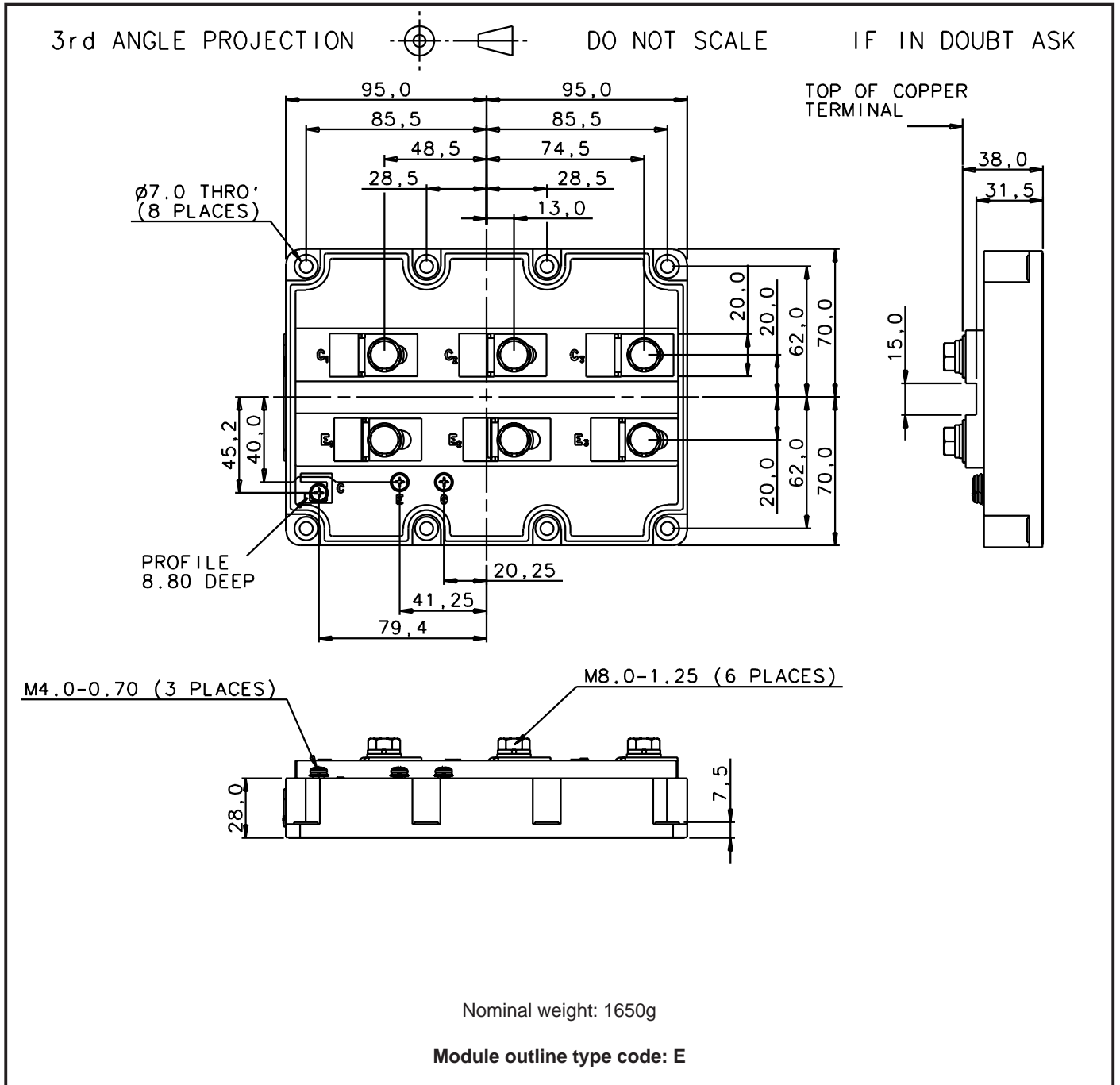

Caution: This device is sensitive to electrostatic discharge. Users should follow ESD handling procedures.

ASSOCIATED PUBLICATIONS

Title	Application Note Number
Electrostatic handling precautions	AN4502
An introduction to IGBTs	AN4503
IGBT ratings and characteristics	AN4504
Heatsink requirements for IGBT modules	AN4505
Calculating the junction temperature of power semiconductors	AN4506
Gate drive considerations to maximise IGBT efficiency	AN4507
Parallel operation of IGBTs – punch through vs non-punch through characteristics	AN4508
Guidance notes for formulating technical enquiries	AN4869
Principle of rating parallel connected IGBT modules	AN5000
Short circuit withstand capability in IGBTs	AN5167
Driving high power IGBTs with concept gate drivers	AN5190

POWER ASSEMBLY CAPABILITY

The Power Assembly group was set up to provide a support service for those customers requiring more than a basic semiconductor switch, and has developed a flexible range of heatsink / clamping systems in line with advances in device types and the voltage and current capability of our semiconductors.

We offer an extensive range of air and liquid cooled assemblies covering the full range of circuit designs in general use today. The Assembly group continues to offer high quality engineering support dedicated to designing new units to satisfy the growing needs of our customers.

Using the latest CAD methods our team of design and applications engineers aim to provide the Power Assembly Complete solution (PACs).

HEATSINKS

Power Assembly has its own proprietary range of extruded aluminium heatsinks. They have been designed to optimise the performance of our semiconductors. Data with respect to air natural, forced air and liquid cooling (with flow rates) is available on request.

For further information on device clamps, heatsinks and assemblies, please contact your nearest Sales Representative or the factory.



<http://www.dynexsemi.com>

e-mail: power_solutions@dynexsemi.com

HEADQUARTERS OPERATIONS
DYNEX SEMICONDUCTOR LTD
Doddington Road, Lincoln.
Lincolnshire. LN6 3LF. United Kingdom.
Tel: +44-(0)1522-500500
Fax: +44-(0)1522-500550

DYNEX POWER INC.
Unit 7 - 58 Antares Drive,
Nepean, Ontario, Canada K2E 7W6.
Tel: 613.723.7035
Fax: 613.723.1518
Toll Free: 1.888.33.DYNEX (39639)

CUSTOMER SERVICE CENTRES
Central Europe Tel: +33 (0)1 69 18 90 00. Fax: +33 (0)1 64 46 54 50.
North America Tel: 011-800-5554-5554. Fax: 011-800-5444-5444.
UK, Scandinavia & Rest Of World Tel: +44 (0)1522 500500. Fax: +44 (0)1522 500020

SALES OFFICES
Central Europe Tel: +33 (0)1 69 18 90 00. Fax: +33 (0)1 64 46 54 50.
North America Tel: (613) 723-7035. Fax: (613) 723-1518. Toll Free: 1.888.33.DYNEX (39639) /
Tel: (831) 440-1988. Fax: (831) 440-1989 / Tel: (949) 733-3005. Fax: (949) 733-2986.
UK, Scandinavia & Rest Of World Tel: +44 (0)1522 500500. Fax: +44 (0)1522 500020.
These offices are supported by Representatives and Distributors in many countries world-wide.
© Dynex Semiconductor 2000 Publication No. DS5360-1 Issue No. 1.1 May 2000
TECHNICAL DOCUMENTATION – NOT FOR RESALE. PRINTED IN UNITED KINGDOM

Datasheet Annotations:

Dynex Semiconductor annotate datasheets in the top right hand corner of the front page, to indicate product status. The annotations are as follows:-

Target Information: This is the most tentative form of information and represents a very preliminary specification. No actual design work on the product has been started.

Preliminary Information: The product is in design and development. The datasheet represents the product as it is understood but details may change.

Advance Information: The product design is complete and final characterisation for volume production is well in hand.

No Annotation: The product parameters are fixed and the product is available to datasheet specification.

This publication is issued to provide information only which (unless agreed by the Company in writing) may not be used, applied or reproduced for any purpose nor form part of any order or contract nor to be regarded as a representation relating to the products or services concerned. No warranty or guarantee express or implied is made regarding the capability, performance or suitability of any product or service. The Company reserves the right to alter without prior notice the specification, design or price of any product or service. Information concerning possible methods of use is provided as a guide only and does not constitute any guarantee that such methods of use will be satisfactory in a specific piece of equipment. It is the user's responsibility to fully determine the performance and suitability of any equipment using such information and to ensure that any publication or data used is up to date and has not been superseded. These products are not suitable for use in any medical products whose failure to perform may result in significant injury or death to the user. All products and materials are sold and services provided subject to the Company's conditions of sale, which are available on request.

All brand names and product names used in this publication are trademarks, registered trademarks or trade names of their respective owners.

Caution: This device is sensitive to electrostatic discharge. Users should follow ESD handling procedures.