



MMIC SURFACE MOUNT

Power Splitter/Combiner

GP2S1+

2 Way-0° 50Ω 500 to 2500 MHz

FEATURES

- Very wide bandwidth, 500 to 2500 MHz
- Excellent isolation, 20 dB typ.
- Excellent amplitude unbalance, 0.02 dB typ.
- Excellent phase unbalance, 0.9 deg. typ.
- Small size, 0.118"x0.118"x0.035"
- High ESD level
- Aqueous washable

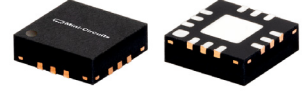

Generic photo used for illustration purposes only

CASE STYLE: DQ1225

+RoHS Compliant

The +Suffix identifies RoHS Compliance. See our website for methodologies and qualifications

APPLICATIONS

- Cellular
- GPS
- Radar
- WCDMA
- GSM
- Korea PCS

ELECTRICAL SPECIFICATIONS

Parameter	Frequency (MHz)	Min.	Typ.	Max.	Units
Frequency Range		500		2500	MHz
Insertion Loss* (above 3.0 dB)	500-2500		0.9	1.8	dB
Isolation	500-2500	9	20		dB
Amplitude Unbalance	500-2500	—	—	0.2	dB
Phase Unbalance	500-2500	—	—	5.0	deg.
VSWR (Port S)	500-2500	—	1.3	—	:1
VSWR (Ports 1,2)	500-2500	—	1.2	—	

* De-embedded from demo board loss.

MAXIMUM RATINGS

Parameter	Ratings
Operating temperature	-40°C to 85°C
Storage temperature	-65°C to 150°C
Power Input (as a splitter)	1.5W max.
Internal Dissipation	0.75W max.

Permanent damage may occur if any of these limits are exceeded.

ELECTRICAL SCHEMATIC





PAD CONNECTIONS

SUM PORT	2
PORT 1	7
PORT 2	9
GROUND	1,3,4,5,6,8,10,11,12, paddle

DEMO BOARD MCL P/N: TB-453-GP2S1+ SUGGESTED PCB LAYOUT (PL-282)

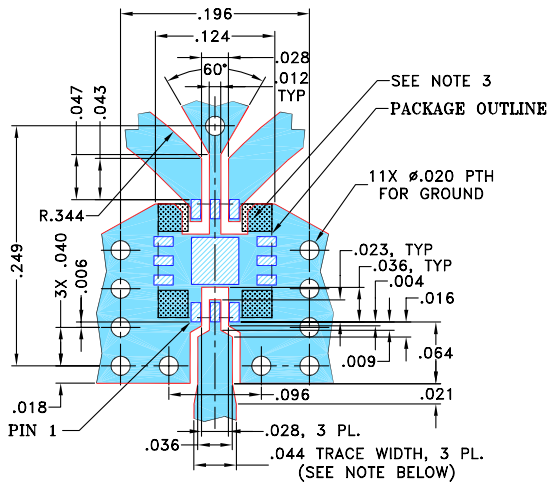

NOTES:

1. TRACE WIDTH IS SHOWN FOR ROGERS R04350B WITH DIELECTRIC THICKNESS .020" ± .0015"; COPPER: 1/2 OZ. EACH SIDE. FOR OTHER MATERIALS TRACE WIDTH AND GAP MAY NEED TO BE MODIFIED.
2. BOTTOM SIDE OF THE PCB IS CONTINUOUS GROUND PLANE.
3. SIGNAL TRACES ARE NOT ALLOWED INSIDE HATCHED AREAS (APPROX. .030 X .030) AT 4 PLACES AS SHOWN.

- DENOTES PCB COPPER LAYOUT WITH SMOBC (SOLDER MASK OVER BARE COPPER)
- DENOTES COPPER LAND PATTERN FREE OF SOLDER MASK

OUTLINE DRAWING

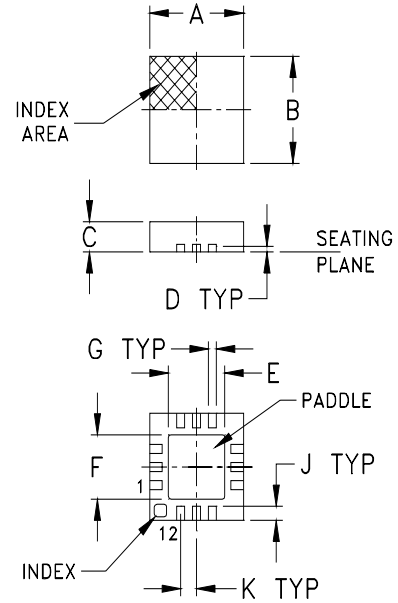

PCB Land Pattern

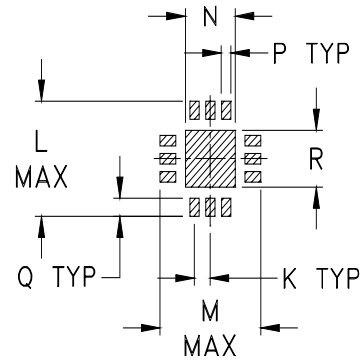

Suggested Layout,
Tolerance to be within ±.002

PRODUCT MARKING

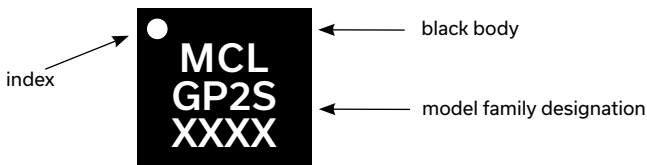

Marking may contain other features or characters for internal lot control

OUTLINE DIMENSIONS (Inch mm)

A	B	C	D	E	F	G	H	J
.118	.118	.035	.008	.057	.057	.009	---	.016
3.00	3.00	0.89	0.20	1.45	1.45	0.23	---	0.41
K	L	M	N	P	Q	R		wt
.020	.127	.127	.049	.010	.020	.049		grams
0.51	3.23	3.23	1.24	0.25	0.51	1.24		0.02

TAPE & REEL INFORMATION: F66



TYPICAL PERFORMANCE DATA AND CHARTS

Frequency (MHz)	Total Loss ¹ (dB)		Amplitude Unbalance (dB)	Isolation (dB)	Phase Unbalance (deg.)	VSWR S	VSWR 1	VSWR 2
	S-1	S-2						
500.00	3.68	3.68	0.01	11.86	0.42	1.52	1.30	1.30
690.00	3.63	3.62	0.01	17.62	0.47	1.31	1.21	1.20
880.00	3.60	3.60	0.00	29.08	0.52	1.12	1.14	1.12
1070.00	3.64	3.65	0.01	26.49	0.66	1.10	1.09	1.07
1260.00	3.74	3.77	0.04	21.01	0.78	1.22	1.04	1.02
1450.00	3.84	3.88	0.04	20.24	0.87	1.30	1.07	1.05
1550.00	3.88	3.92	0.04	21.14	0.91	1.32	1.10	1.08
1640.00	3.91	3.94	0.03	22.91	0.97	1.30	1.14	1.11
1740.00	3.93	3.96	0.03	26.76	1.05	1.27	1.17	1.14
1830.00	3.95	3.97	0.02	34.69	1.16	1.22	1.20	1.17
1930.00	3.96	3.98	0.02	32.63	1.28	1.15	1.22	1.19
2020.00	3.98	3.99	0.01	24.55	1.41	1.08	1.24	1.21
2210.00	4.04	4.05	0.02	16.91	1.65	1.11	1.25	1.23
2400.00	4.16	4.19	0.03	12.90	1.80	1.34	1.24	1.24
2500.00	4.26	4.29	0.03	11.43	1.89	1.47	1.24	1.24

1. Total Loss = Insertion Loss + 3dB splitter loss.

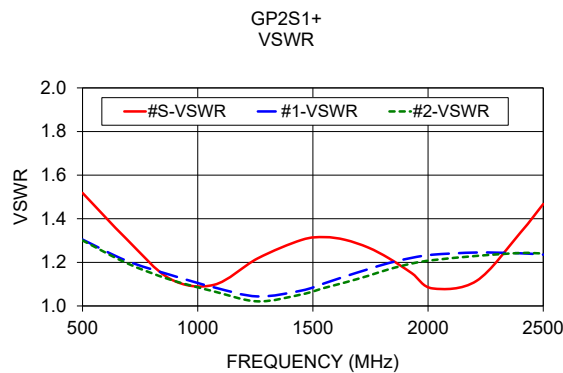
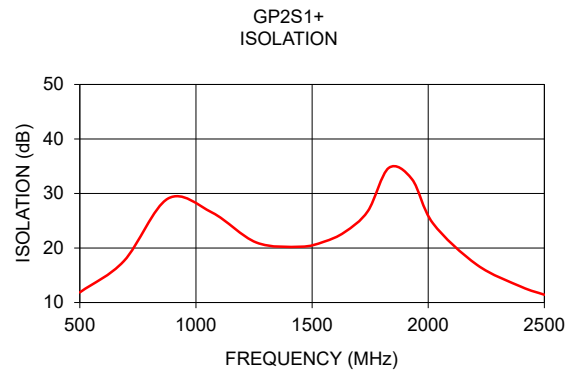
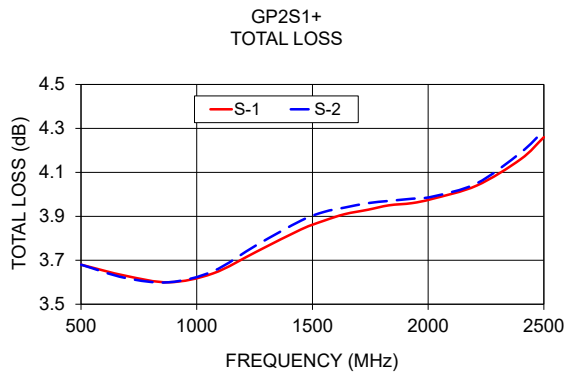

ESD RATING

Human Body Model (HBM): Class 1A (250 to < 500V) in accordance with ANSI/ESD STM 5.1 - 2001

Machine Model (MM): Class M2 (100V to < 250V) in accordance with ANSI/ESD STM 5.2 - 1999

NOTES

- A. Performance and quality attributes and conditions not expressly stated in this specification document are intended to be excluded and do not form a part of this specification document.
- B. Electrical specifications and performance data contained in this specification document are based on Mini-Circuit's applicable established test performance criteria and measurement instructions.
- C. The parts covered by this specification document are subject to Mini-Circuits standard limited warranty and terms and conditions (collectively, "Standard Terms"); Purchasers of this part are entitled to the rights and benefits contained therein. For a full statement of the standard terms and the exclusive rights and remedies thereunder, please visit Mini-Circuits' website at www.minicircuits.com/terms/viewterm.html

