

GP2S27J0000F Series

**SMT, Detecting Distance : 0.7mm
Phototransistor Output,
Compact Reflective
Photointerrupter**



■ Description

GP2S27J0000F Series is a compact-package, phototransistor output, reflective photointerrupter, with emitter and detector facing the same direction in a molding that provides non-contact sensing. The compact package series is a result of unique technology, combining transfer and injection molding, that also blocks visible light to minimize false detection.

This photointerrupter can be ordered in different CTR ranks, and comes in a surface-mount, gullwing lead package, suitable for reflow soldering.

■ Features

1. Reflective with Phototransistor Output
2. Highlights :
 - Compact Size
 - Surface Mount Type (SMT), reflow soldering, with gullwing leads
 - Optional Tape and Reel (T&R) 1 000 pcs per reel
3. Key Parameters :
 - Optimal Sensing Distance : 0.7mm
 - Package : 4×3×1.7mm
 - Visible light cut resin to prevent
4. Lead free and RoHS directive compliant

■ Agency approvals/Compliance

1. Compliant with RoHS directive

■ Applications

1. Detection of object presence or motion.
2. Example : printer, optical storage

Notice The content of data sheet is subject to change without prior notice.
In the absence of confirmation by device specification sheets, SHARP takes no responsibility for any defects that may occur in equipment using any SHARP devices shown in catalogs, data books, etc. Contact SHARP in order to obtain the latest device specification sheets before using any SHARP device.

Internal Connection Diagram

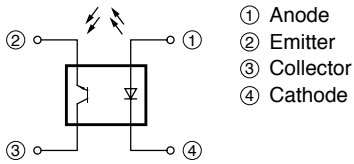

Outline Dimensions

(Unit : mm)

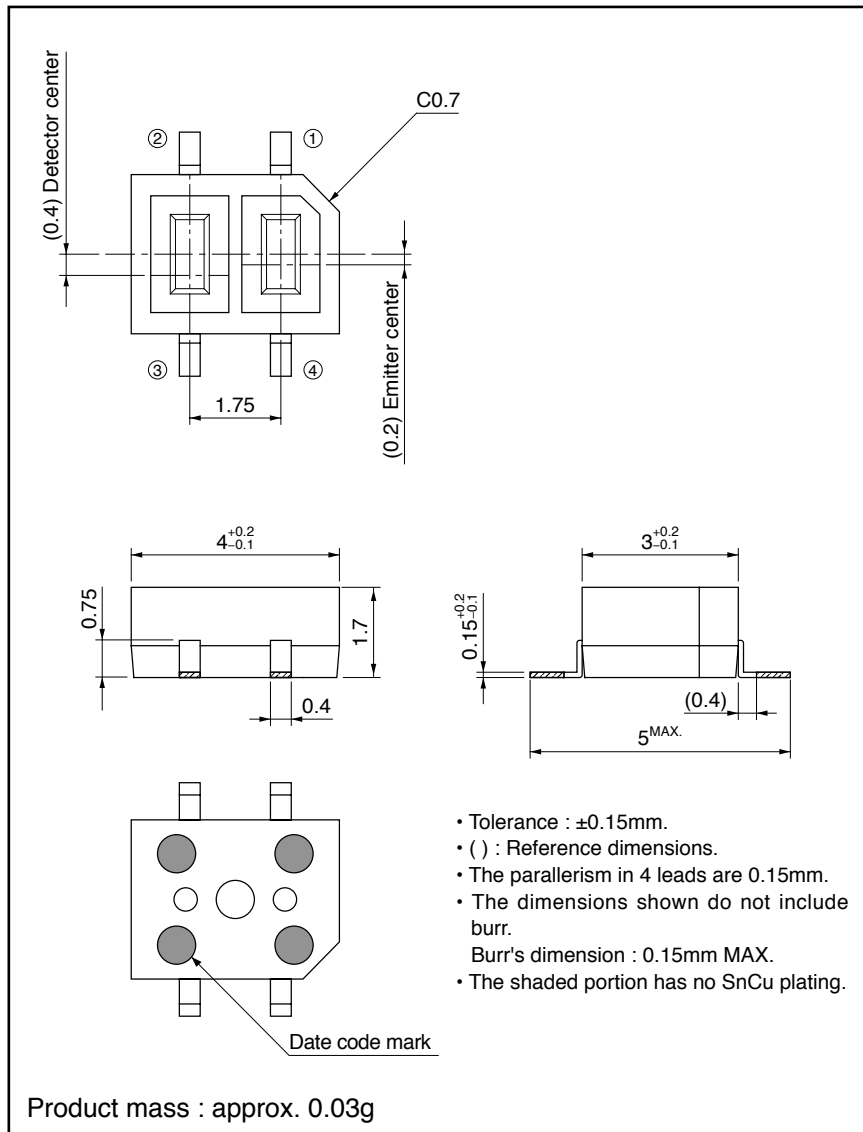

Plating material : SnCu (Cu : TYP. 2%)

Date code (Symbol)

January

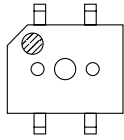

July

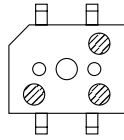

February

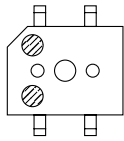

August

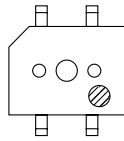

March

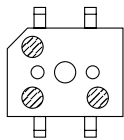

September

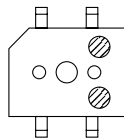

April

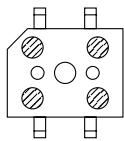

October

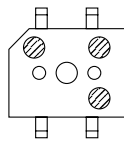

May

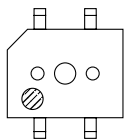

November

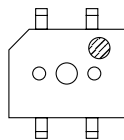

June

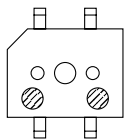

December

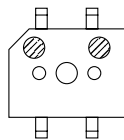

Rank mark

There is no rank indicator.

Country of origin

Japan

■ Absolute Maximum Ratings

($T_a=25^\circ\text{C}$)

| Parameter | | Symbol | Rating | Unit |
|--------------------------|-----------------------------|-----------|-------------|------------------|
| Input | Forward current | I_F | 50 | mA |
| | Reverse voltage | V_R | 6 | V |
| | Power dissipation | P | 75 | mW |
| Output | Collector-emitter voltage | V_{CEO} | 35 | V |
| | Emitter-collector voltage | V_{ECO} | 6 | V |
| | Collector current | I_C | 20 | mA |
| | Collector power dissipation | P_C | 75 | mW |
| Total power dissipation | | P_{tot} | 100 | mW |
| Operating temperature | | T_{opr} | -25 to +85 | $^\circ\text{C}$ |
| Storage temperature | | T_{stg} | -40 to +100 | $^\circ\text{C}$ |
| *1 Soldering temperature | | T_{sol} | 260 | $^\circ\text{C}$ |

*1 For 5s or less

Soldering area:

The hatched area more than 0.5mm away from the lower edge of package as shown in the figure below.

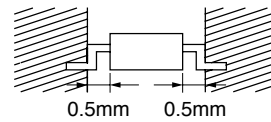

■ Electro-optical Characteristics

($T_a=25^\circ\text{C}$)

| Parameter | | Symbol | Condition | MIN. | TYP. | MAX. | Unit | |
|--------------------------|------------------------|-----------|---------------------|--|------|------|---------------|---------------|
| Input | Forward voltage | V_F | $I_F=20\text{mA}$ | - | 1.2 | 1.4 | V | |
| | Reverse current | I_R | $V_R=6\text{V}$ | - | - | 10 | μA | |
| Output | Collector dark current | I_{CEO} | $V_{CE}=20\text{V}$ | - | 1 | 100 | nA | |
| Transfer characteristics | *2 Collector Current | | I_C | $I_F=4\text{mA}, V_{CE}=2\text{V}$ | 20 | 45 | 120 | μA |
| | Response time | Rise time | t_r | $V_{CE}=2\text{V}, I_C=100\mu\text{A},$ $R_L=1\text{k}\Omega, d=1\text{mm}$ | - | 20 | 100 | μs |
| | | Fall time | t_f | | - | 20 | 100 | |
| | *3 Leak current | | I_{LEAK} | $I_F=4\text{mA}, V_{CE}=2\text{V}$ | - | - | 100 | nA |

*2 The condition and arrangement of the reflective object are shown below.
The rank splitting of collector current (I_C) shall be executed according to the table below.

| Rank | Collector current, I_C [μA] ($I_F=4\text{mA}, V_{CE}=2\text{V}$) | Package oleeve color |
|------|--|----------------------|
| A | 20 to 42 | Yellow |
| B | 34 to 71 | Transparent |
| C | 58 to 120 | Green |

*3 Without reflective object.

● Test Condition and Arrangement for Collector Current

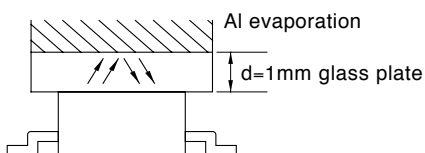

■ Model Line-up

| Package | Sleeve | Taping | Rank | Collector current $I_C[\mu A]$ ($I_F=4mA$, $V_{CE}=2V$, $T_a=25^\circ C$) |
|----------|---------------------|---------------------|-----------|--|
| | 50 pcs/sleeve | 1 000 pcs/reel | | |
| Model No | GP2S27J0000F | GP2S27TJ000F | A, B or C | 20 to 120 |
| | GP2S27BJ000F | GP2S27T2J00F | B | 34 to 71 |
| | GP2S27CJ000F | GP2S27T3J00F | C | 58 to 120 |
| | GP2S27ABJ00F | GP2S27T5J00F | A or B | 20 to 71 |
| | GP2S27BCJ00F | GP2S27T6J00F | B or C | 34 to 120 |

* The ratio of each rank can not be guaranteed.

Please contact a local SHARP sales representative to see the actual status of the production.

Fig.1 Forward Current vs. Ambient Temperature

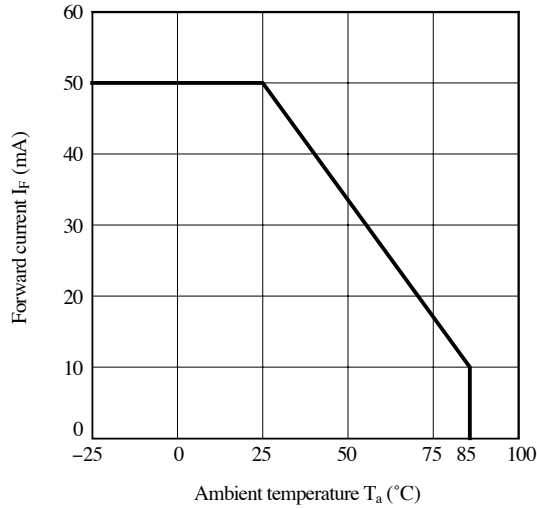

Fig.2 Power Dissipation vs. Ambient Temperature

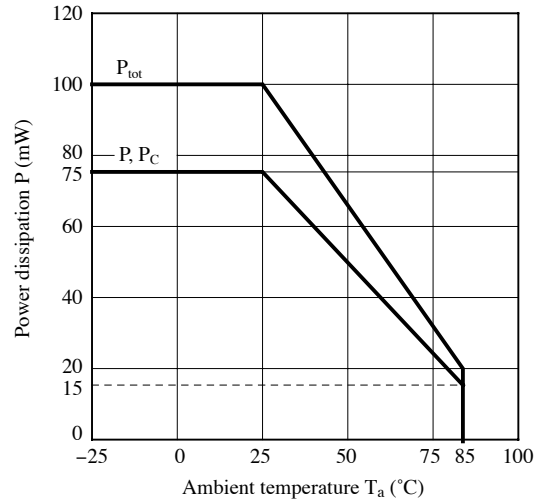

Fig.3 Forward Current vs. Forward Voltage

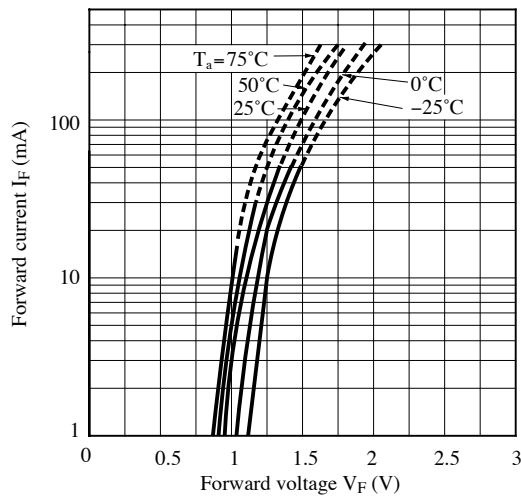

Fig.4 Collector Current vs. Forward Current

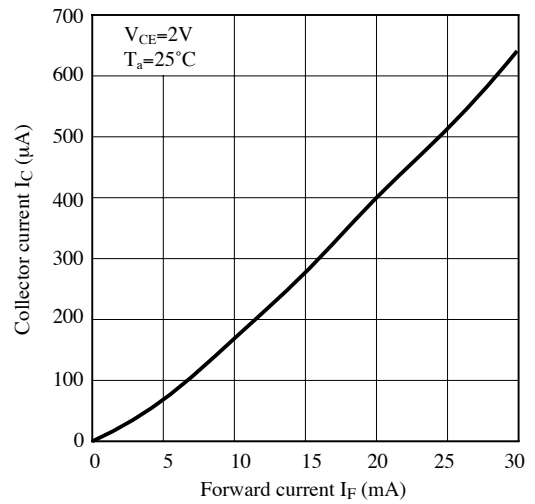

Fig.5 Collector Current vs. Collector-Emitter Voltage

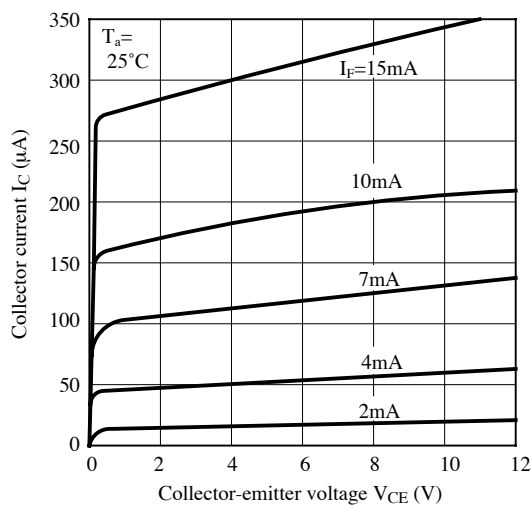

Fig.6 Relative Collector Current vs. Ambient Temperature

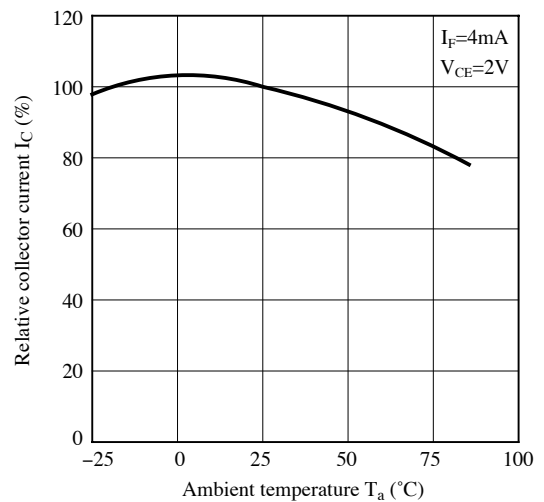

Fig.7 Collector Dark Current vs. Ambient Temperature

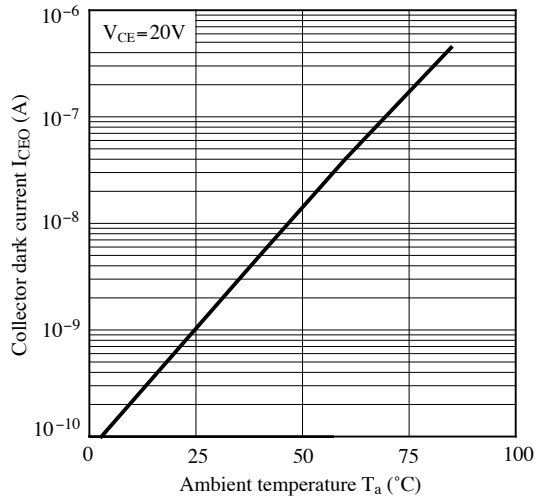

Fig.8 Response Time vs. Load Resistance

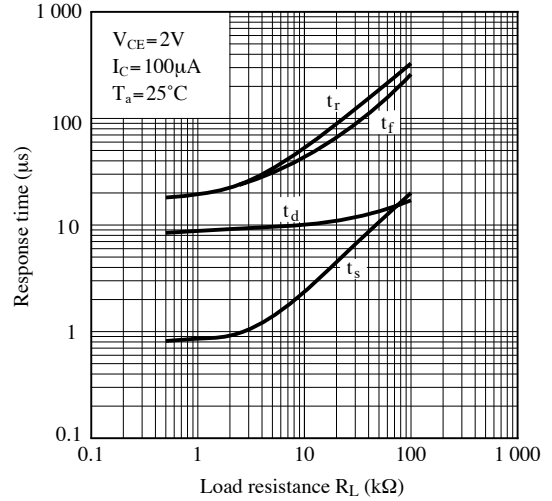

Fig.9 Test Circuit for Response Time

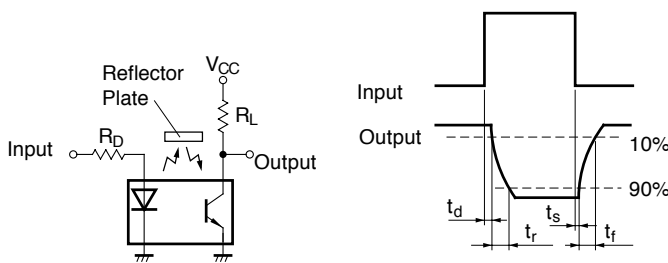

Fig.10 Relative Collector Current vs. Distance (Reference value)

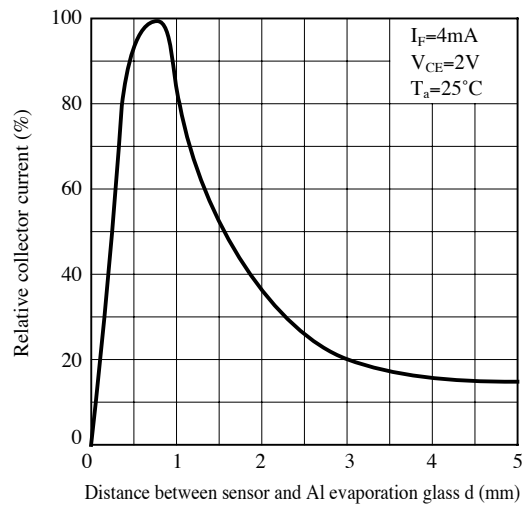

Fig.11 Detecting Position Characteristics (1)

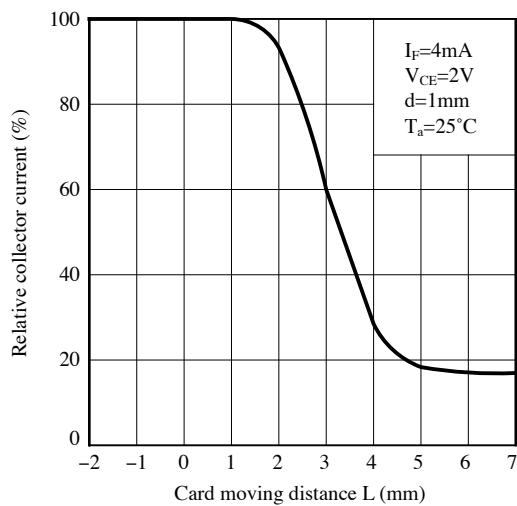

Fig.12 Detecting Position Characteristics (2)

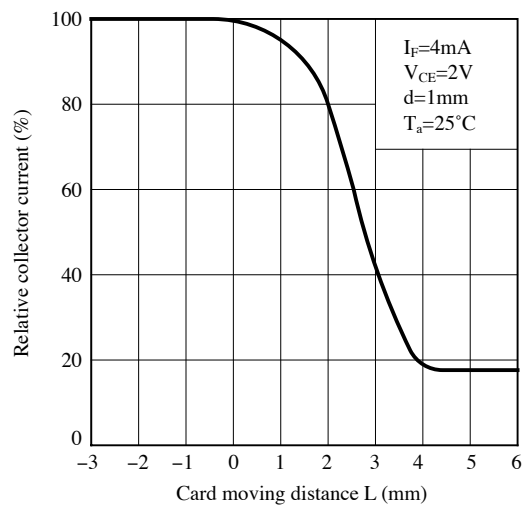

Fig.13 Test Condition for Distance & Detecting Position Characteristics

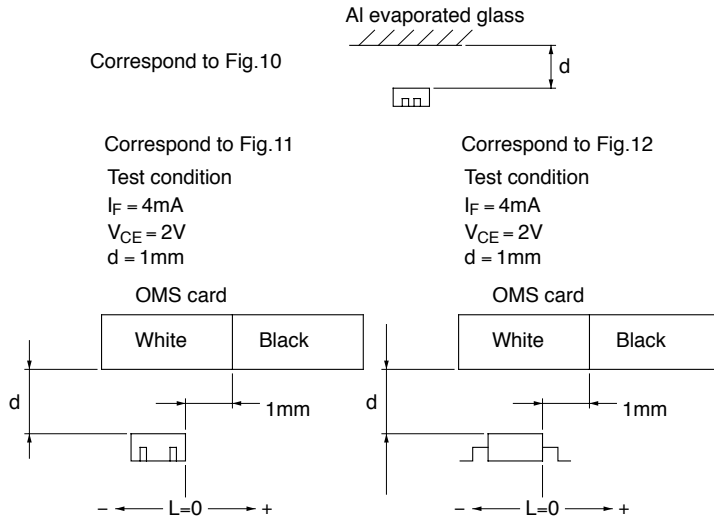

Fig.14 Frequency Response

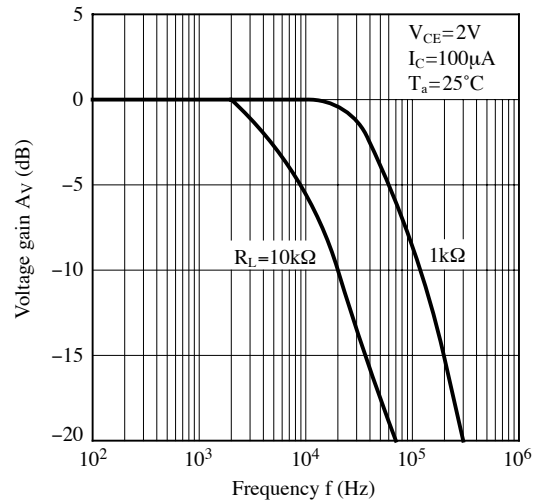
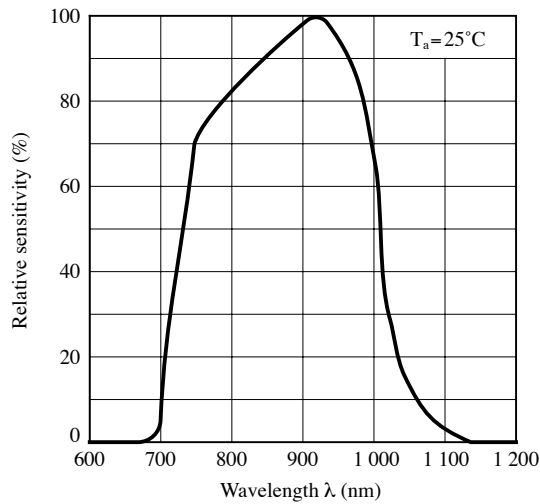

Fig.15 Spectral Sensitivity (Detecting Side)



Remarks : Please be aware that all data in the graph are just for reference and not for guarantee.

■ Design Considerations

● Design guide

1) Prevention of detection error

To prevent photointerrupter from faulty operation caused by external light, do not set the detecting face to the external light.

2) Distance characteristic

Please refer to Fig.10 (Relative collector current vs. Distance) to set the distance of the photointerrupter and the object.

This product is not designed against irradiation and incorporates non-coherent IRED.

● Degradation

In general, the emission of the IRED used in photointerrupter will degrade over time.

In the case of long term operation, please take the general IRED degradation (50% degradation over 5 years) into the design consideration.

● Parts

This product is assembled using the below parts.

• Photodetector (qty. : 1)

| Category | Material | Maximum Sensitivity wavelength (nm) | Sensitivity wavelength (nm) | Response time (μs) |
|-----------------|--------------|-------------------------------------|-----------------------------|--------------------|
| Phototransister | Silicon (Si) | 930 | 700 to 1 200 | 20 |

• Photo emitter (qty. : 1)

| Category | Material | Maximum light emitting wavelength (nm) | I/O Frequency (MHz) |
|--|-------------------------|--|---------------------|
| Infrared emitting diode (non-coherent) | Gallium arsenide (GaAs) | 950 | 0.3 |

• Material

| Case | Lead frame | Lead frame plating |
|-----------------------------------|------------|--------------------|
| Black polyphenylene sulfide resin | 42Alloy | SnCu plating |

■ **Manufacturing Guidelines**

● **Storage and management after open**

Storage condition

Storage temp.: 5 to 30°C, Storage humidity : 70%RH or less at regular packaging.

Treatment after opening the moisture-proof package

After opening, you should mount the products while keeping them on the condition of 5 to 25°C and 70%RH or less in humidity within 4 days.

After opening the bag once even if the prolonged storage is necessary, you should mount the products within two weeks.

And when you store the rest of products you should put into a DRY BOX. Otherwise after the rest of products and silicagel are sealed up again, you should keep them under the condition of 5 to 30°C and 70%RH or less in humidity.

Baking before mounting

When the above-mentioned storage method could not be executed, please process the baking treatment before mounting the products.

However the baking treatment is permitted within one time.

Recommended condition : 125°C, 16 to 24 hours

*Do not process the baking treatment with the product wrapped. When the baking treatment processing, you should move the products to a metallic tray or fix temporarily the products to substrate.

● **Soldering Method**

Reflow Soldering:

Reflow soldering should follow the temperature profile shown below.
Soldering should not exceed the curve of temperature profile and time.
Please solder within one time.

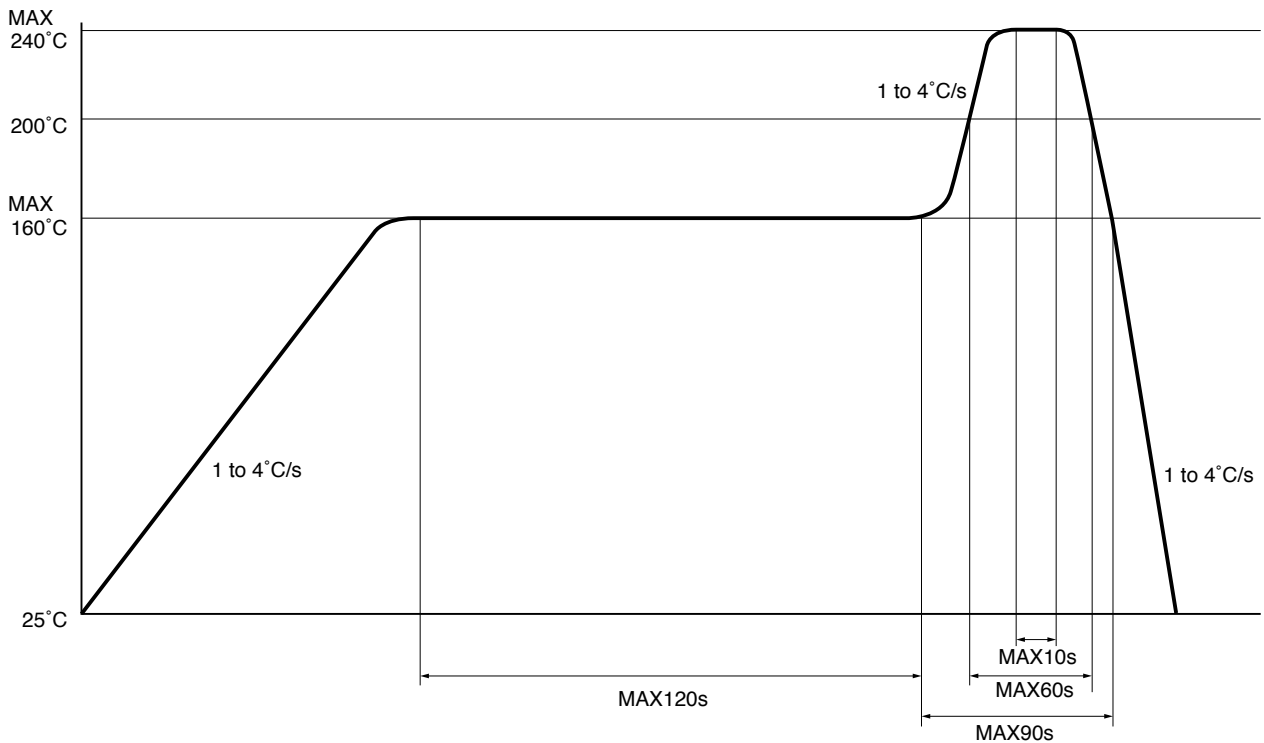

Other notice

Please test the soldering method in actual condition and make sure the soldering works fine, since the impact on the junction between the device and PCB varies depending on the cooling and soldering conditions.

Lead pin

Lead terminals of this product are tin copper alloy plated. Before usage, please evaluate solderability with actual conditions and confirm. And the uniformity in color for the lead terminals are not specified.

● Cleaning instructions

Solvent cleaning :

Solvent temperature should be 45°C or below. Immersion time should be 3 minutes or less.

Ultrasonic cleaning :

Do not execute ultrasonic cleaning.

Recommended solvent materials :

Ethyl alcohol, Methyl alcohol and Isopropyl alcohol.

● Presence of ODC

This product shall not contain the following materials.

And they are not used in the production process for this product.

Regulation substances : CFCs, Halon, Carbon tetrachloride, 1.1.1-Trichloroethane (Methylchloroform)

Specific brominated flame retardants such as the PBBOs and PBBs are not used in this product at all.

This product shall not contain the following materials banned in the RoHS Directive (2002/95/EC).

•Lead, Mercury, Cadmium, Hexavalent chromium, Polybrominated biphenyls (PBB), Polybrominated diphenyl ethers (PBDE).

■ Package specification**● Sleeve package**

Package materials

Sleeve : Polystyrene

Stopper : Styrene-Butadiene

Aluminum laminated bag : Nylone, Polyethylene, Aluminum

Package method

MAX. 50 pcs. of products shall be packaged in a sleeve. Both ends shall be closed by tabbed and tabless stoppers.

MAX. 40 sleeves in one case.

Color of sleeve

Rank classification is distinguished by the color of the sleeve as shown in the table below.

But the ratio of each rank can not be guaranteed.

| Rank | Color of sleeve |
|------|-----------------|
| A | Yellow |
| B | Transparent |
| C | Green |

● Tape and Reel package

Package materials

Carrier tape : A-PET (with anti-static material)

Cover tape : PET (three layer system)

Reel : PS

Package method

1 000 pcs of products shall be packaged in a reel. One reel with silicagel is encased in aluminum laminated bag. After sealing up the bag, it encased in one case (5 bags/case).

Carrier tape structure and Dimensions

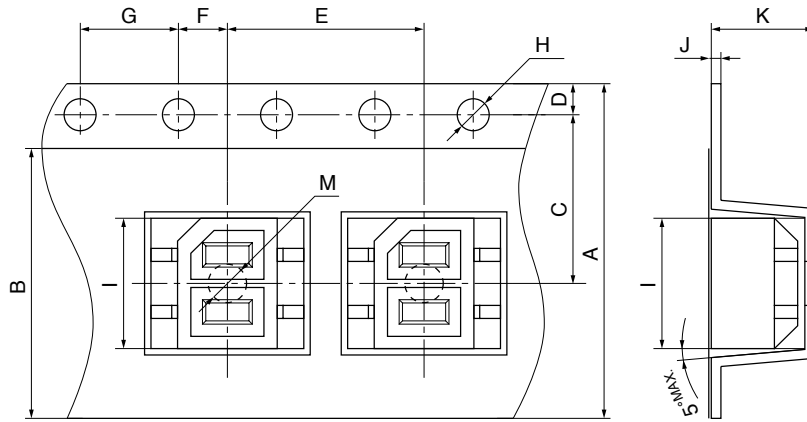

Dimensions List (Unit : mm)

| A | B | C | D | E | F | G |
|------------------------------------|-----------------------------------|----------------------|----------------------|---------------------|------------------------------------|-------------------|
| 12 ^{+0.3} | 7.6 ^{+0.3} ₋₀ | 5.5 ^{+0.05} | 1.75 ^{+0.1} | 8 ^{+0.1} | 2 ^{+0.05} | 4 ^{+0.1} |
| H | I | J | K | L | M | |
| φ1.5 ^{+0.1} ₋₀ | 4.4 ^{+0.1} | 0.3 ^{+0.05} | 2 ^{+0.1} | 5.2 ^{+0.1} | φ1.6 ^{+0.1} ₋₀ | |

Reel structure and Dimensions

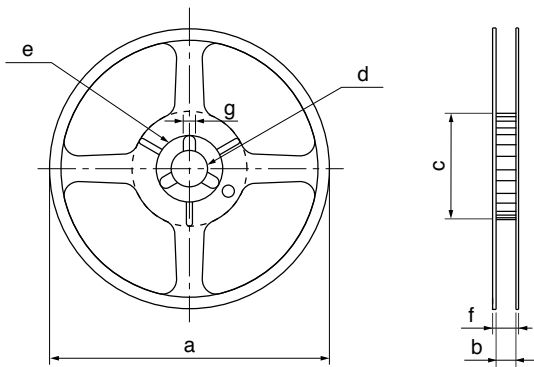

Dimensions List (Unit : mm)

| a | b | c | d |
|--------------------|--------------------|----------------------------------|--------------------|
| 180 | 13 ^{+0.8} | 60 ^{+0.5} ₋₀ | 13 ^{+0.2} |
| e | f | g | |
| 21 ^{+0.8} | 15.4 ⁺¹ | 2 ^{+0.3} ₋₀ | |

Direction of product insertion

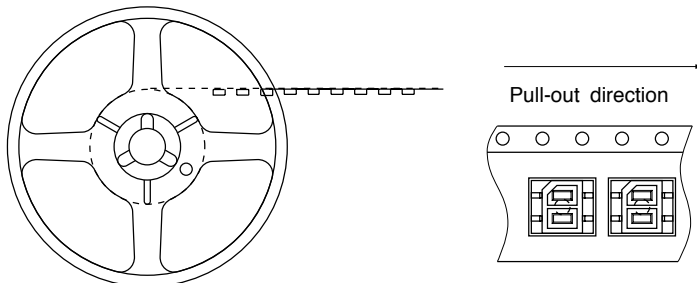

[Packing : 1 000pcs/reel]

Storage method

Storage conditions should follow the condition shown below.

Storage temperature : 5 to 30°C

Storage humidity : 70%RH or less

■ Important Notices

· The circuit application examples in this publication are provided to explain representative applications of SHARP devices and are not intended to guarantee any circuit design or license any intellectual property rights. SHARP takes no responsibility for any problems related to any intellectual property right of a third party resulting from the use of SHARP's devices.

· Contact SHARP in order to obtain the latest device specification sheets before using any SHARP device. SHARP reserves the right to make changes in the specifications, characteristics, data, materials, structure, and other contents described herein at any time without notice in order to improve design or reliability. Manufacturing locations are also subject to change without notice.

· Observe the following points when using any devices in this publication. SHARP takes no responsibility for damage caused by improper use of the devices which does not meet the conditions and absolute maximum ratings to be used specified in the relevant specification sheet nor meet the following conditions:

(i) The devices in this publication are designed for use in general electronic equipment designs such as:

- Personal computers
- Office automation equipment
- Telecommunication equipment [terminal]
- Test and measurement equipment
- Industrial control
- Audio visual equipment
- Consumer electronics

(ii) Measures such as fail-safe function and redundant design should be taken to ensure reliability and safety when SHARP devices are used for or in connection

with equipment that requires higher reliability such as:

- Transportation control and safety equipment (i.e., aircraft, trains, automobiles, etc.)
- Traffic signals
- Gas leakage sensor breakers
- Alarm equipment
- Various safety devices, etc.

(iii) SHARP devices shall not be used for or in connection with equipment that requires an extremely high level of reliability and safety such as:

- Space applications
- Telecommunication equipment [trunk lines]
- Nuclear power control equipment
- Medical and other life support equipment (e.g., scuba).

· If the SHARP devices listed in this publication fall within the scope of strategic products described in the Foreign Exchange and Foreign Trade Law of Japan, it is necessary to obtain approval to export such SHARP devices.

· This publication is the proprietary product of SHARP and is copyrighted, with all rights reserved. Under the copyright laws, no part of this publication may be reproduced or transmitted in any form or by any means, electronic or mechanical, for any purpose, in whole or in part, without the express written permission of SHARP. Express written permission is also required before any use of this publication may be made by a third party.

· Contact and consult with a SHARP representative if there are any questions about the contents of this publication.