

DATA SHEET



GPES213B2

Easy-to-use SOUNDPLUS

JAN. 06, 2009

Version 1.1

GENERALPLUS TECHNOLOGY INC. reserves the right to change this documentation without prior notice. Information provided by GENERALPLUS TECHNOLOGY INC. is believed to be accurate and reliable. However, GENERALPLUS TECHNOLOGY INC. makes no warranty for any errors which may appear in this document. Contact GENERALPLUS TECHNOLOGY INC. to obtain the latest version of device specifications before placing your order. No responsibility is assumed by GENERALPLUS TECHNOLOGY INC. for any infringement of patent or other rights of third parties which may result from its use. In addition, GENERALPLUS products are not authorized for use as critical components in life support devices/systems or aviation devices/systems, where a malfunction or failure of the product may reasonably be expected to result in significant injury to the user, without the express written approval of Generalplus.

Table of Contents

	<u>PAGE</u>
TABLE OF CONTENTS	2
EASY-TO-USE SOUNDPLUS	3
1. GENERAL DESCRIPTION	3
2. BLOCK DIAGRAM	3
3. FEATURES	3
4. SIGNAL DESCRIPTIONS	4
4.1. PAD ASSIGNMENT	4
5. FUNCTIONAL DESCRIPTIONS	5
5.1. INSTRUCTION SETS	5
5.2. I/O DESCRIPTION	5
5.3. PROGRAM STRUCTURE OVERVIEW	5
5.3.1. Definition area	5
5.3.2. Entry point (Label)	6
6. GPES II PROGRAMMING TOOL	7
7. ELECTRICAL SPECIFICATIONS	8
7.1. ABSOLUTE MAXIMUM RATINGS	8
7.2. DC CHARACTERISTICS (VDD = 3.0V, T _A = 25°C)	8
7.3. DC CHARACTERISTICS (VDD = 4.5V, T _A = 25°C)	8
7.4. (3VOLT) R RELATIVE F _{OSC} TABLE (THE TABLE IS ONLY FOR REFERENCE)	8
7.5. THE RELATIONSHIPS BETWEEN THE R _{OSC} AND THE F _{OSC}	9
7.5.1. VDD = 3.0V, T _A = 25 °C	9
7.5.2. VDD = 4.5V, T _A = 25 °C	9
7.6. THE RELATIONSHIPS BETWEEN THE F _{OSC} AND THE I _{OP}	9
7.7. THE RELATIONSHIPS BETWEEN THE F _{OSC} AND THE VDD	9
8. APPLICATION CIRCUITS	10
8.1. 4 INPUTS, 2 LEDs AND 6 OUTPUTS	10
8.2. 28 INPUTS KEY MATRIX	10
8.3. 36 INPUTS KEY MATRIX	11
8.4. PTG PIN PULL-HIGH RESISTANCE	11
9. PACKAGE/PAD LOCATIONS	12
9.1. ORDERING INFORMATION	12
10. DISCLAIMER	13
11. REVISION HISTORY	14

Easy-to-use SOUNDPLUS

1. GENERAL DESCRIPTION

The easy-to-use SOUNDPLUS II (GPESII) is an enhanced version of easy-to-use SOUNDPLUS (GPES). Many features have been added in GPES II to increase its capability and performance. One of the most significant features in GPES II is that no complex program structure is necessary. With only nine instructions and six registers, GPES II is capable of driving sophisticated tasks and playing realistic sound with simple program structure. Programmer can easily implement application rapidly and increase productivity efficiently.

The GPES213B2, one of the GPES II families, stores up to 13 seconds of sound data (@ 6.0KHz sample rate). It also contains four trigger pins, eight output pins, PWM audio output, and five LED flash alternations. To assure the system reliability, a watchdog and a Low Voltage Reset (LVR) are also built in for monitoring possible critical conditions. With the high cost/performance ratio, GPES213B2 is one of the most suitable engines in the industry for vocal products.

2. BLOCK DIAGRAM

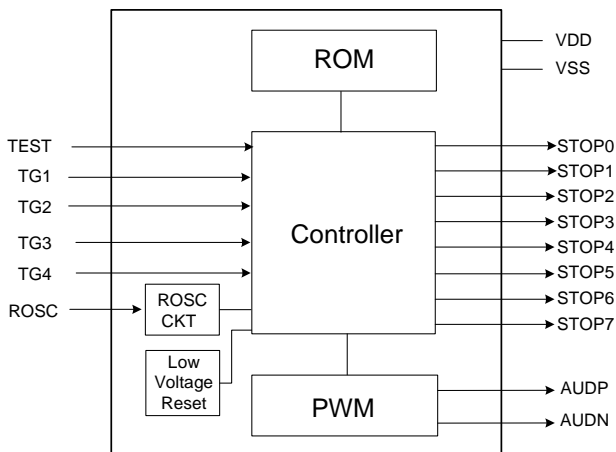

3. FEATURES

- 44KB ROM SIZE
- Programmable speech synthesizer
- Operating voltage:
 - 1.9V - 5.5V for 4.0MHz operating clock
 - 3.6V - 5.5V for 6.0MHz operating clock
- 4 direct trigger inputs that can be extended to 36 matrix key
- Up to 8 programmable outputs
- Programmable power on initialization
- 256 voice group entries available
- Mask options: Trigger input debounce time from 5ms to 35ms
- Flexible functions through the following:
 - LD (load), JP (jump) commands
 - 6 registers: R0, R1, R2, R3, EN, STOP
 - Conditional instructions
 - Speech equation
 - END instruction
 - Local repeat setting
 - Output frequency and LED flash type setting
- Approx. 13 sec. speech (6KHz sample rate)
- Low voltage reset function
- Watchdog function
- A pair of PWM outputs
- Flexible functions as the follows:
 - Interrupt or non-interrupt for rising or falling edge of each trigger.
 - Eight programmable playing modes:
 - One shot
 - Level hold
 - Single-cycle level hold
 - Complete-cycle level hold
 - Sequence
 - Level-Auto
 - Random
 - Non-retrigger
 - Stop signal output setting
- Each voice section provides
 - Programmable sampling frequency:
 - 2K to 10K for 4.0MHz operating clock
 - 2K to 15K for 6.0MHz operating clock
 - Five LED flash type : On, Off, Alternatively, Synchronous, Volume-controlled
 - LED: programmable
- Infrared Red (IR) communication Function
- Play Speech with tags, Seven different tags are available

4. SIGNAL DESCRIPTIONS

Mnemonic	PIN No.	Type	Description
TG4 - 1	2 - 5	I	Trigger input pins
TEST	11	I	TEST pin
STOP7 - 6	19 - 18	O	Open drain output pins / LED drive pins
STOP5 - 0	17 - 12	O	Output signals pins
AUDP, AUDN	9, 8	O	A pair of PWM outputs for speak
ROSC	1	I	Oscillator frequency control pin
VDD	20	I	Digital circuit power supply pin
AVDD	10	I	PWM power supply pin
VSS	6	I	Digital circuit power supply pin
AVSS	7	I	PWM power supply pin

4.1. PAD Assignment

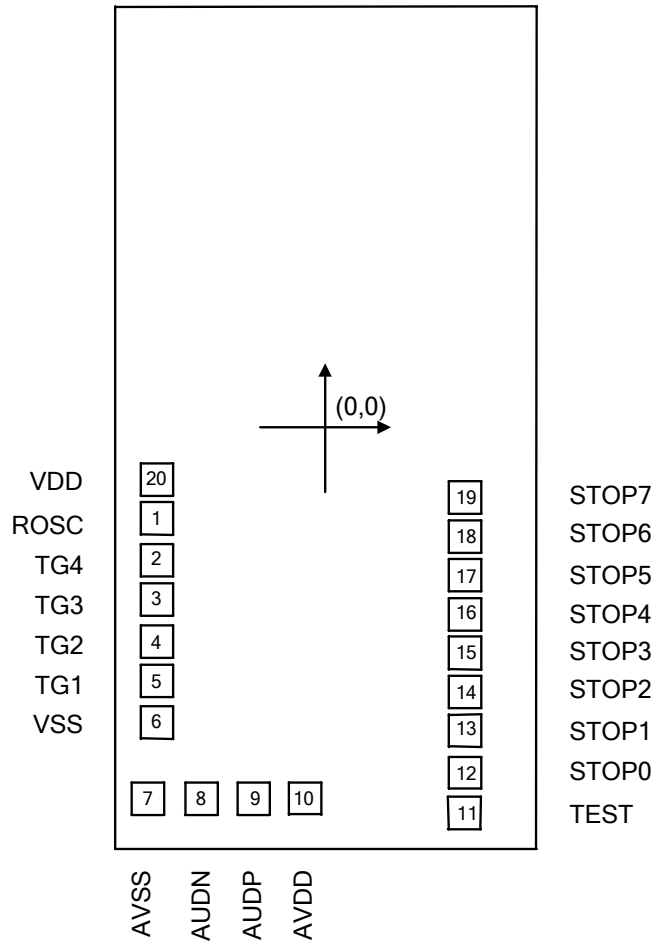

This IC substrate should be connected to VSS

Note1: To ensure that the IC functions properly, bond all VDD and VSS pins.

Note2: The 0.1µF capacitor between VDD and VSS should be placed to IC as close as possible.

5. FUNCTIONAL DESCRIPTIONS

5.1. Instruction Sets

Nine instructions involve *LD*, *JP*, *LSR*, *ADD*, *SUB*, *AND*, *ORR*, *EOR*, and *END*. “LD” represents LOAD and “JP” indicates JUMP. “LSR” shifts a register’s value one bit to the right. “ADD” and “SUB” are addition and subtraction. “AND”, “ORR” and “EOR” are logical operations which indicate AND, OR and, Exclusive OR respectively. “END” ends program and enters into sleep mode for power saving purpose.

5.2. I/O Description

GPES II has the following I/O pins: TG1, TG2, TG3, TG4, STOP [0:7]. The TG1, TG2, TG3 and TG4 are input pins and STOP [0:7] are output pins; moreover, STOP [6:7] can be shared with LED drive pins.

PIN	Configuration
TG1	Input
TG2	Input
TG3	Input
TG4	Input
STOP.0	Output
STOP.1	Output
STOP.2	Output
STOP.3	Output
STOP.4	Output
STOP.5	Output
STOP.6	Output (shared with LED2 pin)
STOP.7	Output (shared with LED1 pin)

5.3. Program Structure Overview

The following description is an overview of GPES II program structure. For more information about GPES II programming method, please refer to GPES II Programming Guide.

5.3.1. Definition area

The beginning of a program is the Definition Area that defines some declarations before Initialization such as IC body, variable, frequency, debounce time and low voltage reset option.

5.3.1.1. IC body

The first element defined in a program is a GPES II body.

Example:

```

SPES213B      ;select SPES213B
EXT_CLK_4M
Freq4        ;Set default speech
              ;sample frequency to 7.8K

LVR_DISABLE
...
POI:
...
...

```

5.3.1.2. Debounce

A key debounce time can be defined in Definition Area. The range of debounce time is 5ms ~ 35ms.

5.3.1.3. Variable

A variable can be defined by adding a “#define” in front of a variable. A variable can be the combination of numbers and characters, but not underscore.

Variable Syntax:

```
#define VariableName <Register | NUM>
```

Example1:

```
#define var R0 ;define var as R0
```

Example2:

```
#define const 8 ;define const as 8
```

5.3.1.4. External clock

Users can define one external clock out of the following selections in a program. This option must be defined in definition area.

EXT_CLK_3M; (3.0MHz)

EXT_CLK_4M; (4.0MHz)

EXT_CLK_6M; (6.0MHz)

5.3.1.5. Low voltage reset

The Low Voltage Reset (LVR), prevents system running into malfunction state, will intend to reset all functions back to the initial states if power VDD drops too low. The LVR works the same as Power-on Reset; it can be enabled or disabled via programming and must be defined in the definition area.

LVR_ENABLE; enable
LVR_DISABLE; disable

5.3.1.6. Infrared Red (IR) function

Some IR parameters must be defined in Definition Area before using IR function. We will only introduce the commands here. For more details on how to use these commands in your program, please refer to GPES II Programming Guide.

5.3.2. Entry point (Label)

The essence applied in GPES II is the ENTRY POINT. Each trigger pin is assigned an entry point. Instructions must be located in a new line under its entry point. Any instruction located with the same line as entry point will cause error when compiling. Users can also define a label (ID) for an entry point. A label can be the combinations of number and character, but not underscore. In addition, a label can not start with a number.

Example

```
SpeechLoop:
    Sound1+Sound2
    JP SpeechLoop
```

When a pin is triggered, the program jumps to its corresponding entry point and starts executing. The entry points are fixed values. For instance, '0' is the entry point of TG1 when 1→0. '1' is the entry point of TG2 when 1→0. Users can either use Entry Point ID or Entry Point Abbreviator to express an entry point. A summary of entry point for each trigger pin is as follows:

Entry Point	Entry Point Abbreviator	Status
32	POI	Power on initialization
0	TG1F	TG1 1→0 (falling)
1	TG2F	TG2 1→0 (falling)
2	TG3F	TG3 1→0 (falling)
3	TG4F	TG4 1→0 (falling)
4	TG1R	TG1 0→1 (rising)
5	TG2R	TG2 0→1 (rising)
6	TG3R	TG3 0→1 (rising)
7	TG4R	TG4 0→1 (rising)
8 ~ 253 (except 32)	User-Defined entry point or label	User-Defined
254	Speech event	User-Defined
255	Timer event	User-Defined

Example:

An example is introduced here. Also, all words after semi-colon (;) are for comments only.

```
SPES213B          ;body defined
EXT_CLK_4M
LVR_Disable

POI:
    LD EN, 0x00
    (4000)_3
    LD EN, 0x 03    ;enable TG1 falling and
                   ;TG2 falling
    END

TG1F:
    Sound1          ;when TG1 changes from
                   ;1→0 (High→Low),
                   ;sound1 is played
    END             ;Sleep

TG2F:
    Sound2          ;when TG2 changes from
                   ;1→0, sound2 is played
    END             ;Sleep
```

6. GPES II PROGRAMMING TOOL

GENERALPLUS provides a user-friendly interface that allows users to write, edit, compile and debug GPES II programs. GPES II Programming Tool should be executed under Windows

95, Windows 98, Windows Me and Windows 2000. For more information on how to use GPES II Programming Tool, please refer to GPES II Programming Guide.

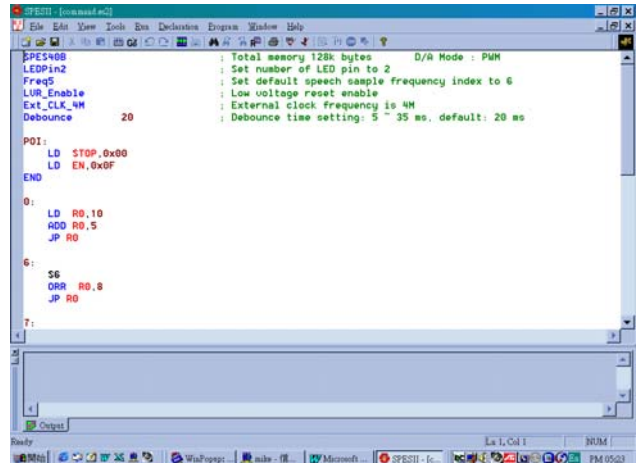

7. ELECTRICAL SPECIFICATIONS

7.1. Absolute Maximum Ratings

Characteristics	Symbol	Ratings
DC Supply Voltage	V_+	< 7.0V
Input Voltage Range	V_{IN}	-0.5V to $V_+ + 0.5V$
Operating Temperature	T_A	0°C to +60°C
Storage Temperature	T_{STO}	-50°C to +150°C

Note: Stresses beyond those given in the Absolute Maximum Rating table may cause operational errors or damage to the device. For normal operational conditions see AC/DC Electrical Characteristics.

7.2. DC Characteristics (VDD = 3.0V, $T_A = 25^\circ\text{C}$)

Characteristics	Symbol	Limit			Unit	Condition
		Min	Typ	Max		
Operating Voltage	VDD	1.9	-	5.5	V	-
STOP7 - 6 Output Current	I_{OL}	-	25	-	mA	VDD = 3.0V, $V_{OUT} = 1.0V$
STOP5 - 0 Output Current	I_{OL}	-	10	-	mA	VDD = 3.0V, $V_{OL} = 1.0V$
	I_{OH}	-	-3.5	-		VDD = 3.0V, $V_{OH} = 2.0V$
Standby Current	I_{STBY}	-	-	2.0	μA	VDD = 3.0V
Operating Current	I_{OP}	-	1.7	-	mA	VDD = 3.0V, $F_{CPU} = 2.0\text{MHz}$ No load
PWM Output Current	I_{OL}	-	100	-	mA	VDD = 3.0V, $V_{OL} = 1.0V$
	I_{OH}	-	-100	-		VDD = 3.0V, $V_{OH} = 2.0V$
R _{OSC} Resistor	R _{OSC}	-	90	-	K Ω	VDD = 3.0V, $F_{OSC} = 4.0\text{MHz}$
Input Current for TG4 - 1	I_{IN}	-	1.8	-	μA	VDD = 3.0V, $V_{IN} = VSS$

7.3. DC Characteristics (VDD = 4.5V, $T_A = 25^\circ\text{C}$)

Characteristics	Symbol	Limit			Unit	Condition
		Min.	Typ.	Max.		
Operating Voltage	VDD	3.6	-	5.5	V	-
STOP7 - 6 Output Current	I_{OL}	-	30	-	mA	VDD = 4.5V, $V_{OUT} = 1.0V$
STOP5 - 0 Output Current	I_{OL}	-	15	-	mA	VDD = 4.5V, $V_{OL} = 1.0V$
	I_{OH}	-	-7	-		VDD = 4.5V, $V_{OH} = 3.5V$
Standby Current	I_{STBY}	-	-	2.0	μA	VDD = 4.5V
Operating Current	I_{OP}	-	3.6	-	mA	VDD = 4.5V, $F_{CPU} = 2.0\text{MHz}$ No load
PWM Output Current	I_{OL}	-	130	-	mA	VDD = 4.5V, $V_{OL} = 1.0V$
	I_{OH}	-	-130	-		VDD = 4.5V, $V_{OH} = 3.5V$
R _{OSC} Resistor	R _{OSC}	-	60	-	K Ω	VDD = 4.5V, $F_{OSC} = 6.0\text{MHz}$
Input Current for TG4 - 1	I_{IN}	-	4.4	-	μA	VDD = 4.5V, $V_{IN} = VSS$

7.4. (3volt) R relative F_{OSC} Table (the table is only for reference)

R(Kohm)	60K Ω	90K Ω	120K Ω
F _{OSC} (MHz)	6	4	3

NOTE*: $F_{CPU} = F_{OSC} / 2$

7.5. The Relationships between the R_{OSC} and the F_{OSC}

7.5.1. $V_{DD} = 3.0V, T_A = 25^\circ C$

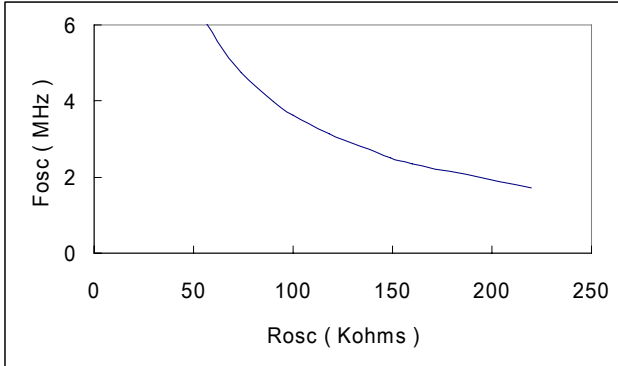

7.5.2. $V_{DD} = 4.5V, T_A = 25^\circ C$

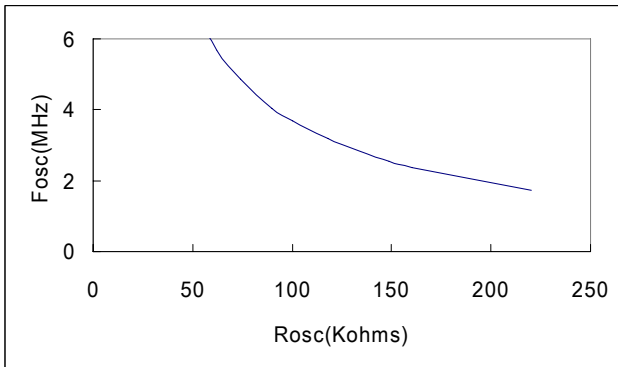

7.6. The Relationships between the F_{OSC} and the I_{OP}

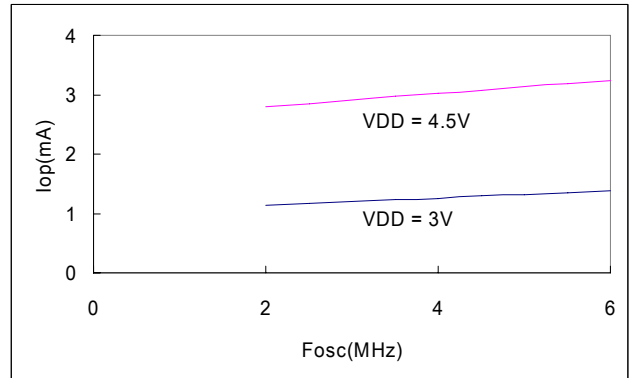

7.7. The Relationships between the F_{OSC} and the V_{DD}

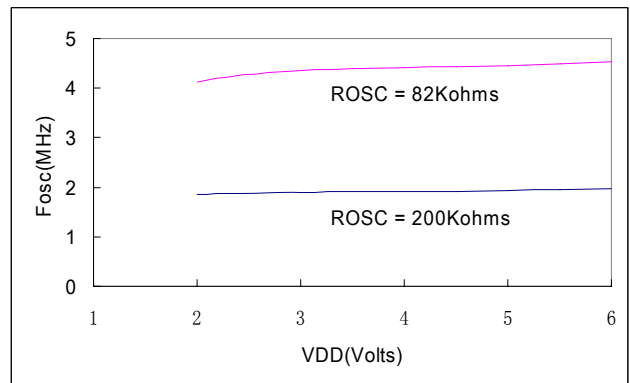

8. APPLICATION CIRCUITS

8.1. 4 Inputs, 2 LEDs and 6 Outputs

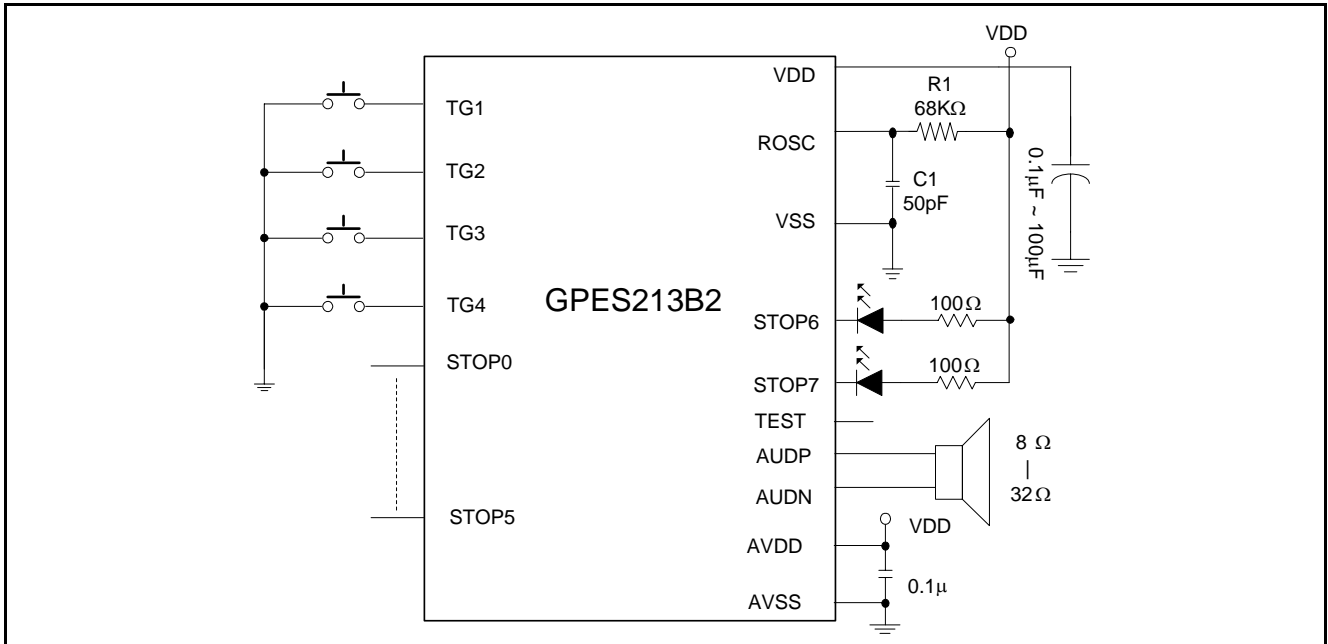

8.2. 28 Inputs Key Matrix

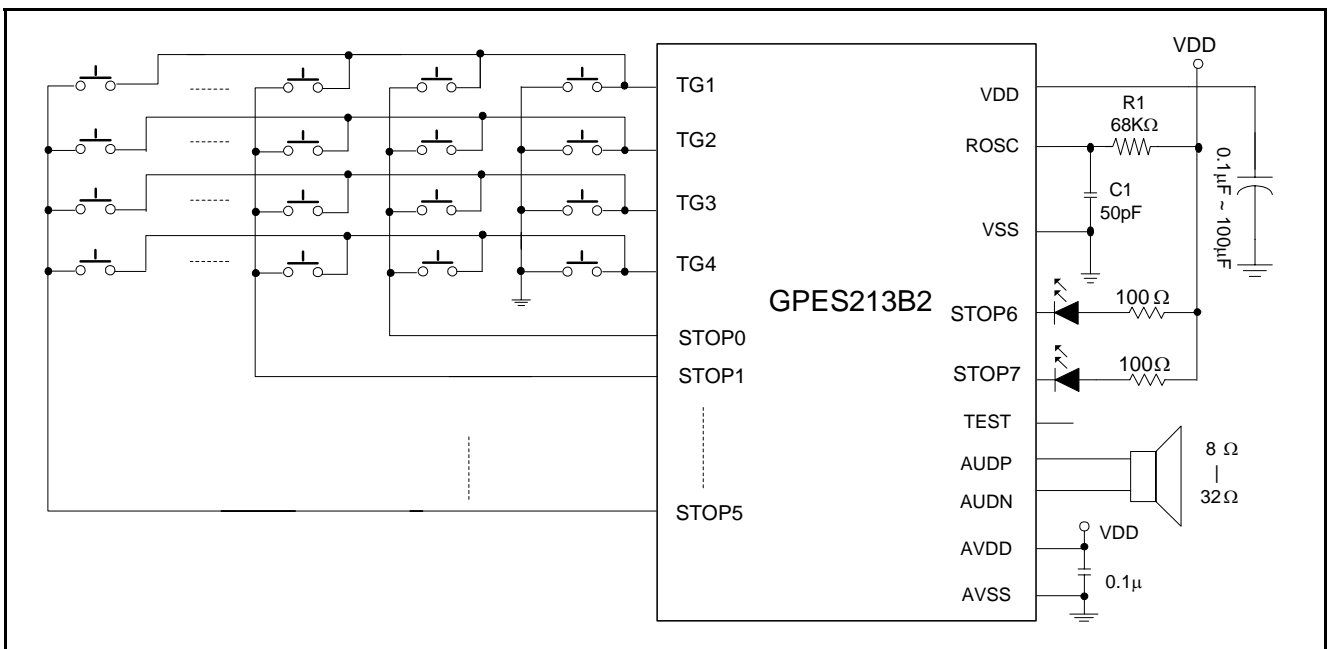

8.3. 36 Inputs Key Matrix

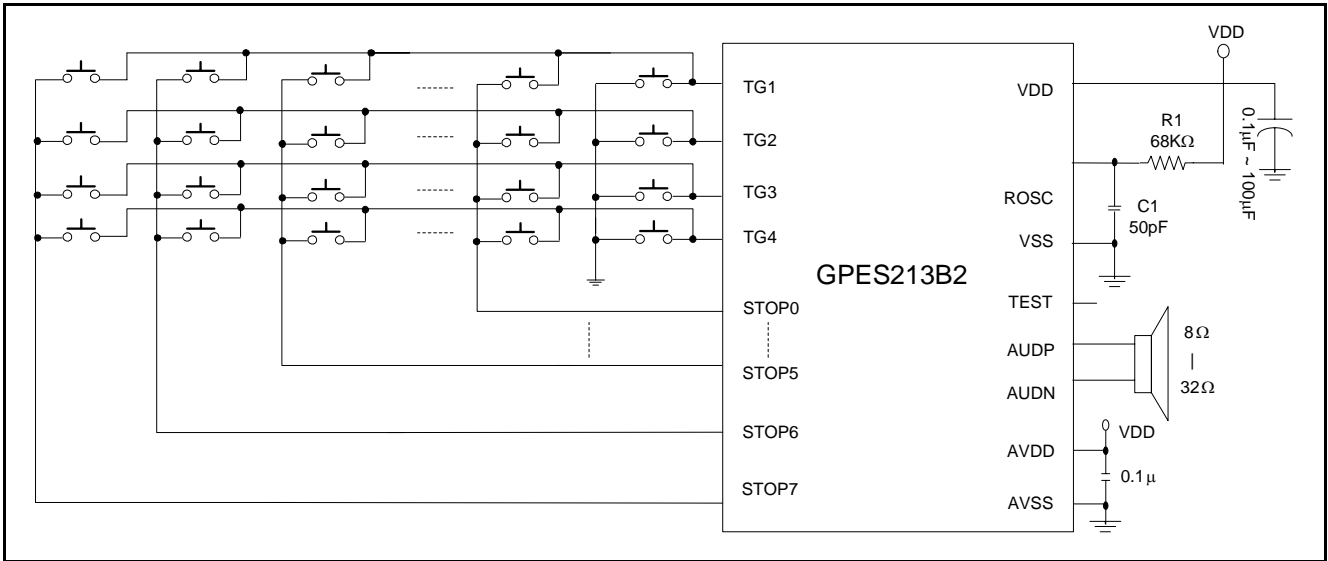

Note: To avoid the noise interference on PCB around R-oscillator, R1 and C1 should be placed as close as possible to ROSC pin.

8.4. PTG pin Pull-High Resistance

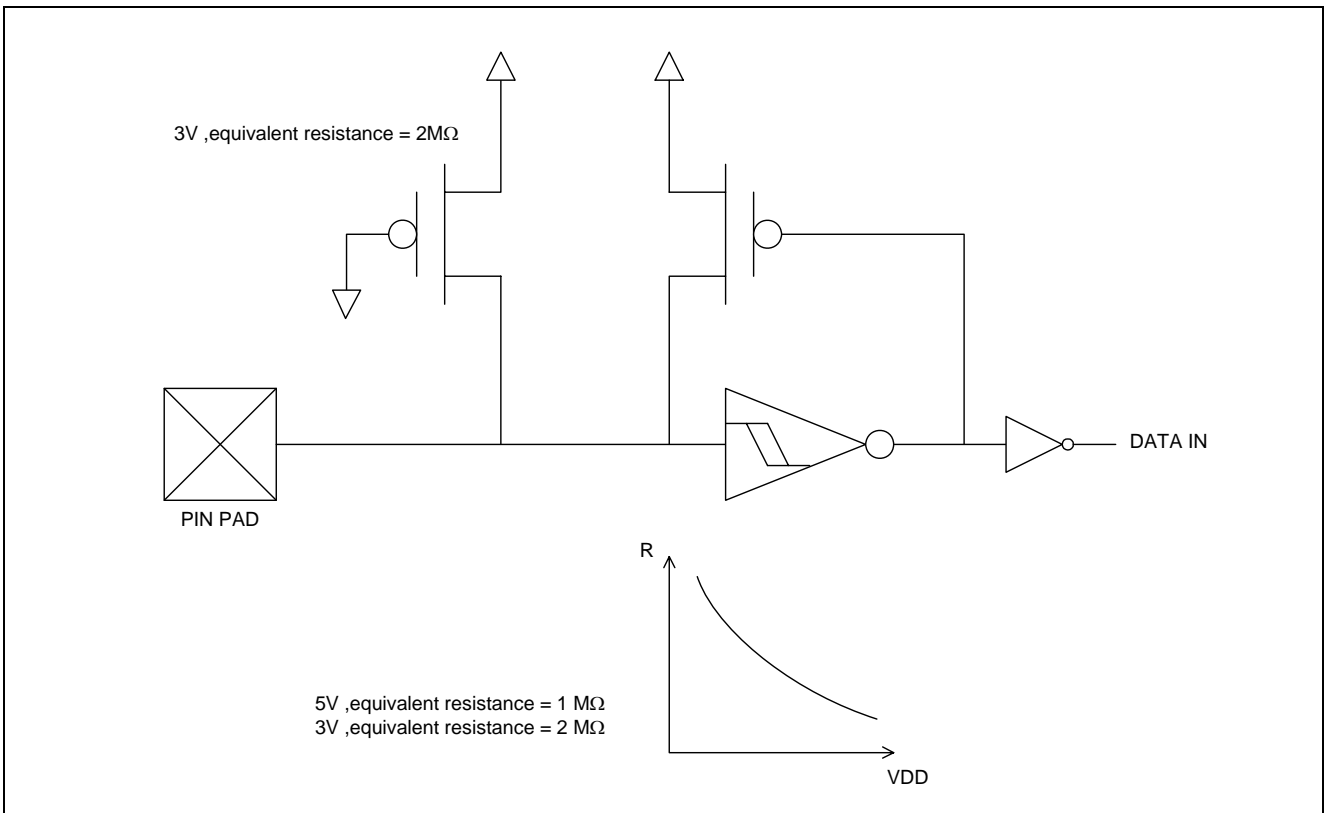

9. PACKAGE/PAD LOCATIONS

9.1. Ordering Information

Product Number	Package Type
GPES213B2-NnnV-C	Chip form

Note1: Code number is assigned for customer.

Note2: Code number (N = A - Z or 0 - 9, nn = 00 - 99); version (V = A - Z).

10. DISCLAIMER

The information appearing in this publication is believed to be accurate.

Integrated circuits sold by Generalplus Technology are covered by the warranty and patent indemnification provisions stipulated in the terms of sale only. GENERALPLUS makes no warranty, express, statutory implied or by description regarding the information in this publication or regarding the freedom of the described chip(s) from patent infringement. FURTHERMORE, GENERALPLUS MAKES NO WARRANTY OF MERCHANTABILITY OR FITNESS FOR ANY PURPOSE. GENERALPLUS reserves the right to halt production or alter the specifications and prices at any time without notice. Accordingly, the reader is cautioned to verify that the data sheets and other information in this publication are current before placing orders. Products described herein are intended for use in normal commercial applications. Applications involving unusual environmental or reliability requirements, e.g. military equipment or medical life support equipment, are specifically not recommended without additional processing by GENERALPLUS for such applications. Please note that application circuits illustrated in this document are for reference purposes only.

11. REVISION HISTORY

Date	Revision #	Description	Page
JAN. 06, 2009	1.1	1. Modify 3 FEATURES.	3
		2. Modify 6.3.1.5 Low voltage reset.	6
		3. Modify 8.2 DC Characteristics.	8
NOV. 03, 2006	1.0	Original	14