

GENERAL DESCRIPTION

This advanced high voltage MOSFET is designed to withstand high energy in the avalanche mode and switch efficiently. This new high energy device also offers a drain-to-source diode with fast recovery time. Designed for high voltage, high speed switching applications such as power supplies, converters, power motor controls and bridge circuits.

FEATURES

- ◆ Higher Current Rating
- ◆ Lower $R_{ds(on)}$
- ◆ Lower Capacitances
- ◆ Lower Total Gate Charge
- ◆ Tighter VSD Specifications
- ◆ Avalanche Energy Specified

PIN CONFIGURATION

TO-220/TO-220FP
Top View

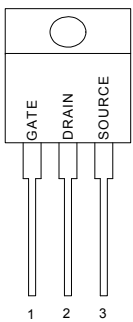

TO-251
Top View

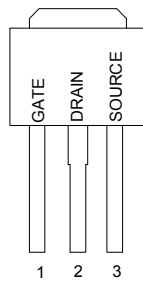

TO-252
Top View

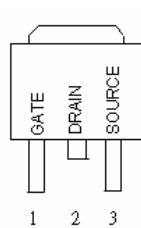

SYMBOL

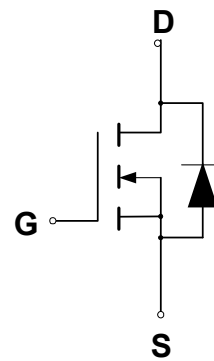

N-Channel MOSFET

ABSOLUTE MAXIMUM RATINGS

Rating	Symbol	Value	Unit
Drain to Current – Continuous	I_D	1.5	A
– Pulsed	I_{DM}	4.5	
Gate-to-Source Voltage – Continue	V_{GS}	± 30	V
Total Power Dissipation TO-251/TO-252	$P_{D(TC)}$	35	W
TO-220		48	
TO-220FP		18	
Derate above 25°C TO-251/TO-252		0.28	W/°C
TO-220		0.32	
TO-220FP		0.12	
Operating and Storage Temperature Range	T_J, T_{STG}	-55 to 150	°C
Single Pulse Drain-to-Source Avalanche Energy – $T_J = 25^\circ\text{C}$ ($V_{DD} = 100\text{V}, V_{GS} = 10\text{V}, I_L = 1.2\text{A}, L = 10\text{mH}, R_G = 25\Omega$)	E_{AS}	7.2	mJ
Thermal Resistance – Junction to Case TO-251/TO-252	θ_{JC}	3.4	°C/W
TO-220		2.9	
TO220FP		6.2	
– Junction to Ambient TO-251/TO-252	θ_{JA}	120	
TO-220, TO-220FP		62.5	
Maximum Lead Temperature for Soldering Purposes, 1/8" from case for 10 seconds	T_L	260	°C

ORDERING INFORMATION

Part Number	Package
GPT02N50AGN220*	TO-220
GPT02N50AGN220FP*	TO-220 Full Package
GPT02N50AGN251*	TO-251
GPT02N50AGN252*	TO-252

*Note: G : Suffix for Pb Free Product

ELECTRICAL CHARACTERISTICS

Unless otherwise specified, $T_J = 25^\circ\text{C}$.

Characteristic		Symbol	GPT02N50A			Units
			Min	Typ	Max	
Drain-Source Breakdown Voltage ($V_{GS} = 0\text{ V}$, $I_D = 250\ \mu\text{A}$)		$V_{(BR)DSS}$	500			V
Drain-Source Leakage Current ($V_{DS} = 500\text{ V}$, $V_{GS} = 0\text{ V}$)		I_{DSS}			1	μA
Gate-Source Leakage Current-Forward ($V_{gsf} = 30\text{ V}$, $V_{DS} = 0\text{ V}$)		I_{GSSF}			100	nA
Gate-Source Leakage Current-Reverse ($V_{gsr} = -30\text{ V}$, $V_{DS} = 0\text{ V}$)		I_{GSSR}			100	nA
Gate Threshold Voltage ($V_{DS} = V_{GS}$, $I_D = 250\ \mu\text{A}$)		$V_{GS(th)}$	2.5	3.5	4.5	V
Static Drain-Source On-Resistance ($V_{GS} = 10\text{ V}$, $I_D = 1.0\text{A}$) *		$R_{DS(on)}$			4.7	Ω
Forward Transconductance ($V_{DS} = 15\text{ V}$, $I_D = 1.0\text{ A}$) *		g_{FS}		1.2		S
Input Capacitance	$(V_{DS} = 25\text{ V}$, $V_{GS} = 0\text{ V}$, $f = 1.0\text{ MHz}$)	C_{iss}		206.9		pF
Output Capacitance		C_{oss}		24.9		pF
Reverse Transfer Capacitance		C_{rss}		1.89		pF
Turn-On Delay Time	$(V_{DD} = 250\text{ V}$, $I_D = 1.5\text{ A}$, $V_{GS} = 10\text{ V}$, $R_G = 9.1\Omega$) *	$t_{d(on)}$		10.8		ns
Rise Time		t_r		12.8		ns
Turn-Off Delay Time		$t_{d(off)}$		61.3		ns
Fall Time		t_f		9.2		ns
Total Gate Charge	$(V_{DS} = 400\text{ V}$, $I_D = 1.5\text{ A}$, $V_{GS} = 10\text{ V}$)*	Q_g		6.85		nC
Gate-Source Charge		Q_{gs}		1.2		nC
Gate-Drain Charge		Q_{gd}		3.55		nC
SOURCE-DRAIN DIODE CHARACTERISTICS						
Forward On-Voltage(1)	$(I_S = 1.5\text{ A}$, $dI_S/dt = 100\text{A}/\mu\text{s}$)	V_{SD}			1.5	V
Forward Turn-On Time		t_{on}		**		ns
Reverse Recovery Time		t_{rr}		124.3		ns

* Pulse Test: Pulse Width $\leq 300\mu\text{s}$, Duty Cycle $\leq 2\%$

** Negligible, Dominated by circuit inductance

TYPICAL ELECTRICAL CHARACTERISTICS

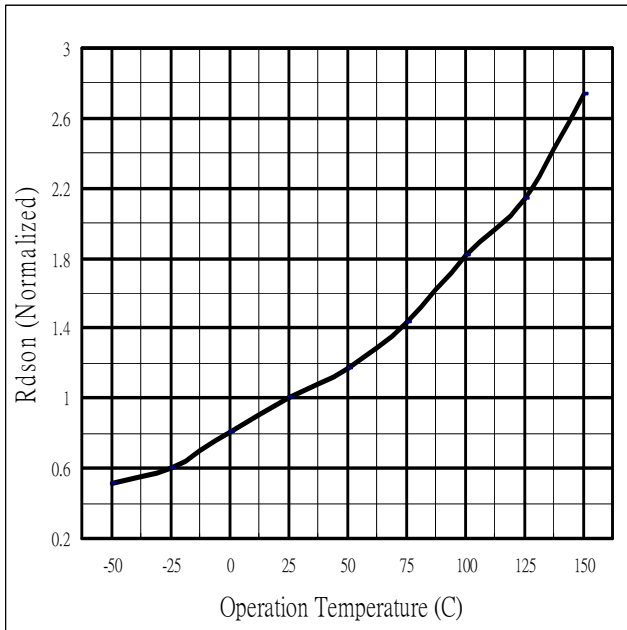

Fig 1. On-Resistance Variation with vs. Temperature

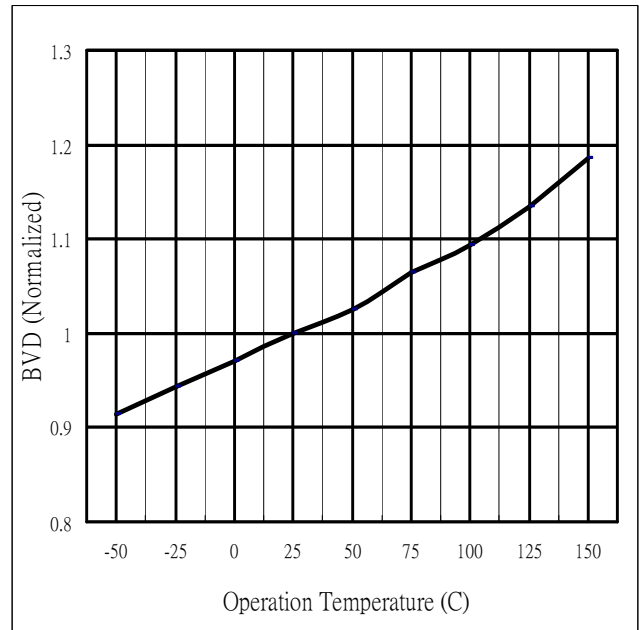

Fig.2 Breakdown Voltage Variation vs. Temperature

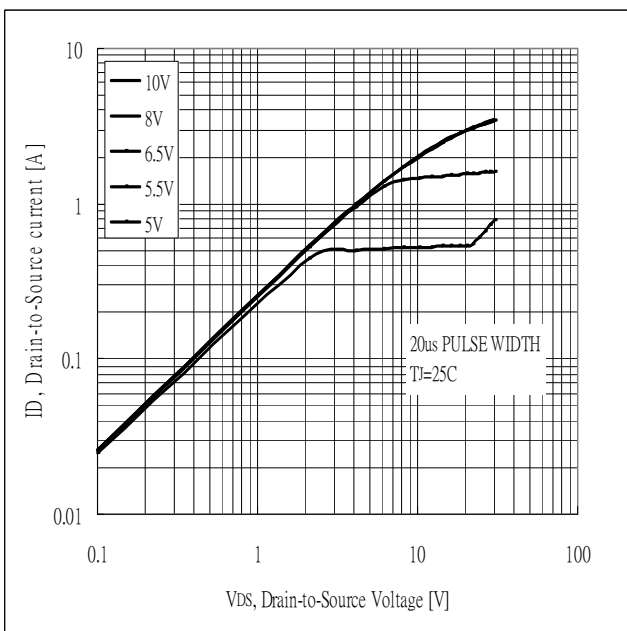

Fig 3. Typical Output Characteristics

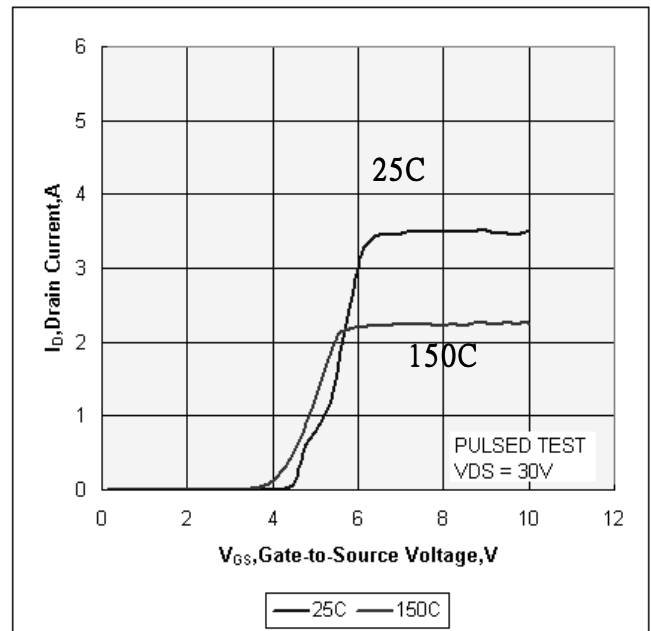

Fig 4. Typical Transfer Characteristics

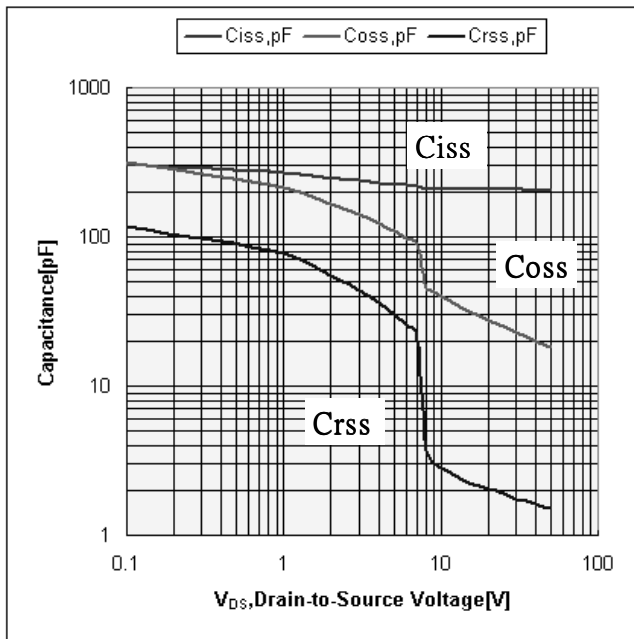

Fig 5. Typical Capacitance Vs. Drain-to-Source Voltage

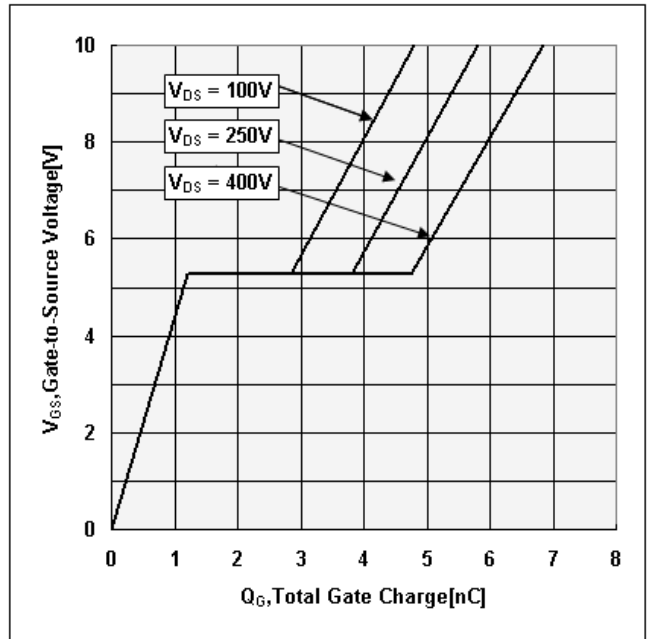
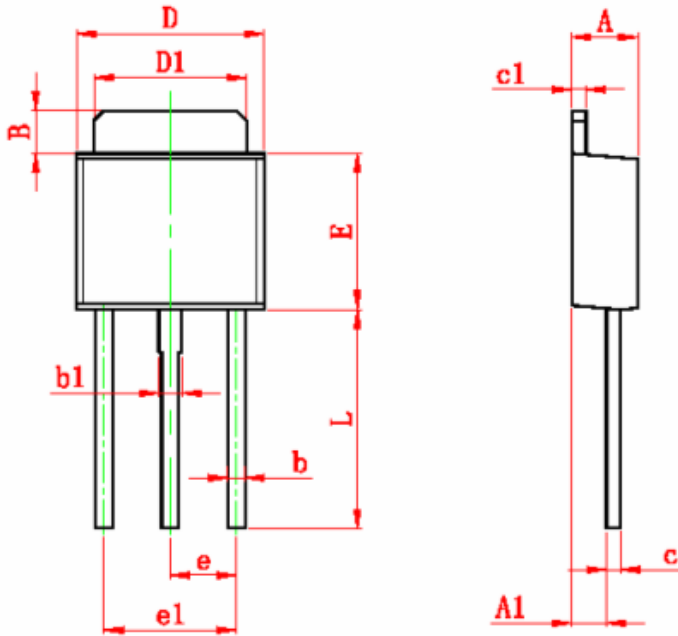

Fig 6. Typical Gate Charge Vs. Gate-to-Source Voltage

PACKAGE DIMENSION

TO-251



Symbol	Dimensions In Millimeters	
	Min.	Max
A	2.10	2.50
A1	0.90	1.35
B	0.90	1.65
b	0.45	0.75
b1	0.65	0.95
c	0.40	0.60
c1	0.40	0.60
D	6.30	6.80
D1	5.00	5.50
E	5.40	6.30
e	2.3 TYP.	
e1	4.40	4.80
L	7.40	8.00

TO-252

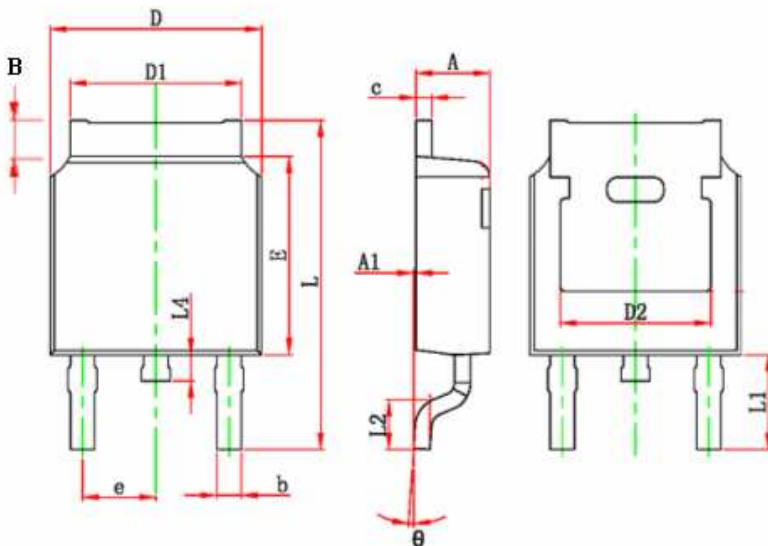

Symbol	Dimensions In Millimeters	
	Min.	Max
A	2.10	2.50
A1	0.90	1.35
B	0.90	1.65
b	0.45	0.90
c	0.40	0.60
D	6.30	6.80
D1	5.00	5.50
D2	4.83 TYP.	
E	5.90	6.30
e	2.3 TYP.	
L	9.30	10.50
L2	1.20	1.80
L4	0.60	1.00
θ	0.00	10.00

TO-220

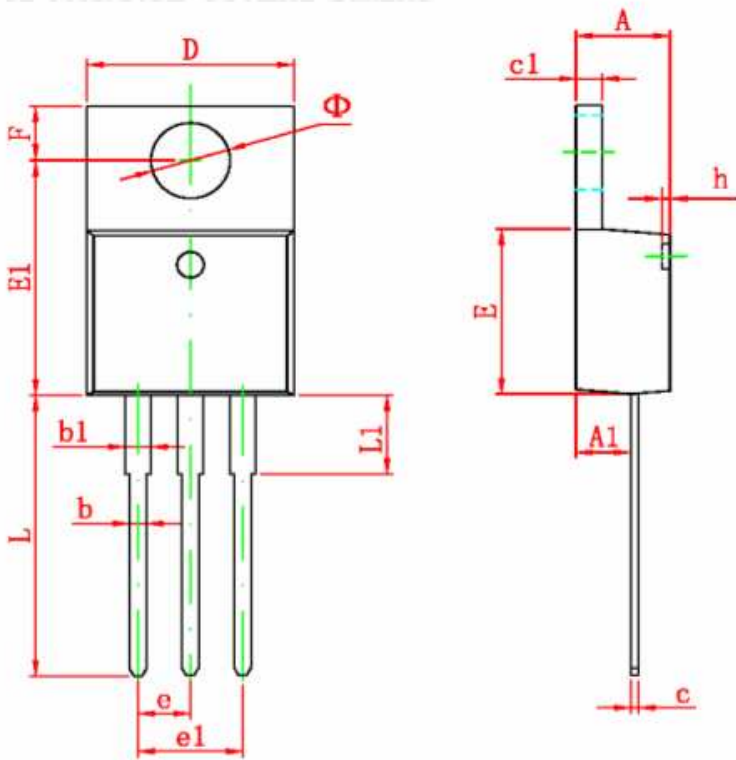

Symbol	Dimensions In Millimeters	
	Min.	Max
A	4.40	4.80
A1	2.10	2.84
b	0.71	0.91
b1	1.17	1.37
c	0.30	0.60
c1	1.17	1.47
D	9.40	10.60
E	8.40	9.60
e	2.54 TYP.	
e1	4.90	5.60
F	3.00 REF.	
Φ	3.50 REF.	
h	0.00	0.30
L	12.50	14.00
L1	3.50	4.00

TO-220FP

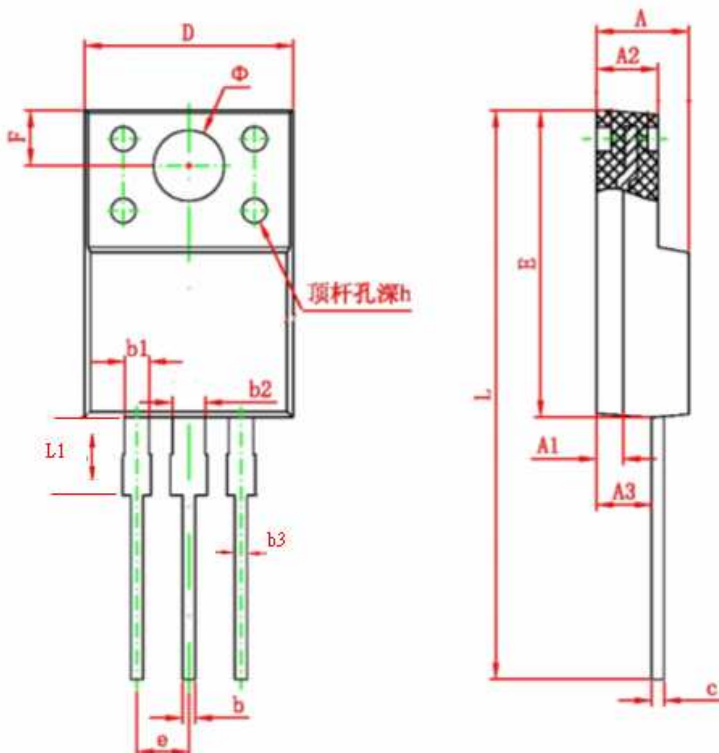

Symbol	Dimensions In Millimeters	
	Min.	Max
A	3.80	4.70
A1	1.3 REF.	
A2	2.20	3.20
A3	2.10	3.20
b	0.30	0.95
b1	1.00	1.75
b2	1.00	1.75
b3	0.50	0.80
c	0.30	0.90
D	9.90	10.40
E	14.60	16.20
e	2.54 TYP.	
F	3.00 REF.	
Φ	3.50 REF.	
h	0.00	0.30
L	28.00	30.00
L1	3.20	3.55

IMPORTANT NOTICE

Great Power Microelectronic Corporation (GP) reserves the right to make changes to its products or to discontinue any integrated circuit product or service without notice, and advises its customers to obtain the latest version of relevant information to verify, before placing orders, that the information being relied on is current.

A few applications using integrated circuit products may involve potential risks of death, personal injury, or severe property or environmental damage. GP integrated circuit products are not designed, intended, authorized, or warranted to be suitable for use in life-support applications, devices or systems or other critical applications. Use of GP products in such applications is understood to be fully at the risk of the customer. In order to minimize risks associated with the customer's applications, the customer should provide adequate design and operating safeguards.



虹冠電子工業股份有限公司
Champion Microelectronic Corporation
Web:<http://www.champion-micro.com/>



深圳市冠順微电子股份有限公司
Shenzhen Great Power Co., Ltd
Web:[http:// www.grtpower.com](http://www.grtpower.com)

臺灣

新北市汐止區新台五路一段 96 號 21F
21F., No. 96, Sec. 1, Sintai 5th Rd.,
Sijhih City, Taipei County 22102,
Taiwan, R. O. C.
TEL: +886-2-2696 3558
FAX: +886-2-2696 3559

深圳

深圳市福田区深南大道 7002 号财富广场 A 座 4V,
4V, Tower A, Fortune Plaza, No. 7002, Shennan
Road, Futian District, Shenzhen City, China
PC : 518040
TEL: +86-755-83709176
FAX: +86-755-83709276
