

**SURFACE MOUNT  
HIGH REPEATABILITY  
SPDT, BROADBAND 18 GHZ,  
40GBPS  
NON-LATCHING RF RELAY**



SERIES	RELAY TYPE
GRF131	RF Non-Latching, SPDT, Surface Mount Relay

**DESCRIPTION**

The ultraminiature Series GRF131 is designed to provide a practical surface-mount switching solution with RF performance and repeatability to 18GHz. The GRF131 improves on Teledyne Relays' heritage of miniature RF relays by incorporating a precision transmission line structure in the internal construction of the contact system. GRF131 relays feature a unique ground shield to facilitate surface mounting and to extend the frequency range when compared to through-hole solutions.

These relays are designed for use in RF attenuators, RF switch matrices, high frequency spread spectrum radios, ATE, and other applications that require dependable high frequency signal fidelity and performance. The low power consumption makes the GRF131 suitable for applications where power budget is restricted.

**The GRF131 features:**

- High Repeatability
- Wide Bandwidth Performance
- Higher Isolation Between Each Signal Path
- Metal Enclosure for EMI Shielding
- High Isolation Between Control and Signal Paths
- High Resistance to ESD

The unique construction features and manufacturing techniques provide excellent robustness for environmental extremes and overall reliability:

- Minimum mass components and welded construction provide maximum resistance to shock and vibration
- Advanced cleaning techniques provide maximum assurance of internal cleanliness
- Gold-plated precious metal alloy contacts ensure reliable switching
- Hermetic Seal
- RoHS Compliant

ENVIRONMENTAL AND PHYSICAL SPECIFICATIONS		
<b>Temperature</b> (Ambient)	Storage	-55°C to +125°C
	Operating	-55°C to +85°C
<b>Vibration</b> (Note 1)		10 g's; 10 to 1000 Hz
<b>Shock</b> (Note 1)		30 g's, 6ms half sine
<b>Spacing Between Adjacent Relays</b>		0.02 in. (Min)
<b>Enclosure</b>		Hermetically sealed
<b>Weight</b>		0.14 oz (4.0 g)

# Series GRF131

SPDT Non-Latching  
DC-18GHz RF Relay  
40Gbps



**TELEDYNE  
RELAYS**  
Everywhereyoulook™

## GENERAL ELECTRICAL SPECIFICATIONS (-55 °C to 85 °C unless otherwise noted.)(Notes 2 & 3.)

<b>Contact Arrangement</b>	1 Form C (SPDT), with open contact grounded to case
<b>Rated Duty</b>	Continuous
<b>Contact Load Rating</b>	Resistive: 0.25A @ 28Vdc (based off GRF121 data)
<b>Contact Life Rating</b>	2,000,000 cycles typical @ low level
<b>Coil Operating Power</b>	315mW typical @ nominal rated voltage
<b>Switching Time</b>	10 ms. max. (5 ms operate time, 2ms release time, 5 ms bounce time)
<b>Insulation Resistance</b>	1,000MΩ min. between mutually isolated terminals
<b>Dielectric Strength</b>	350 Vrms (60Hz) @ Atmospheric Pressure
<b>Propagation Delay</b>	54-60 ps typical

## DETAILED ELECTRICAL SPECIFICATIONS (-55 °C to 85 °C unless otherwise noted.) (Note 3)

BASE PART NUMBERS	GRF131-5	GRF131-12
<b>Coil Voltage, Nominal (Vdc)</b>	5.0	12.0
<b>Coil Resistance (Ohms ±20%)</b>	80	460
<b>Pick-up Voltage, Max (Vdc)</b>	4.3	10.4

## Part Numbering System (Notes 4 & 6)

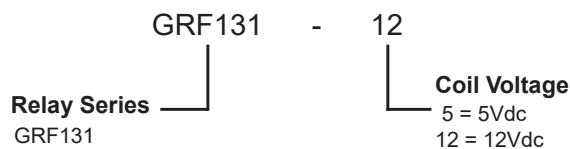

## GENERAL NOTES

1. Relay contacts will exhibit no chatter in excess of 10 μs or transfer in excess of 1 μs.
2. Characteristics shown as "typical" are based on available data and are best estimates. No ongoing verification tests are performed.
3. Unless otherwise specified, parameters are initial values.
4. Relay leads are gold plated with a typical thickness of 25-40 μin. Ground shield is gold plated with a typical thickness of 10-30μin.
5. Operate voltage at less than the specified nominal coil voltage may result in unreliable operation.
6. Relay temperature during soldering shall not exceed 250°C, and reflow temperature shall not exceed 250°C, 3 passes, 1 minute each.

**RF CHARACTERISTICS (See RF Notes)**

**Insertion Loss**

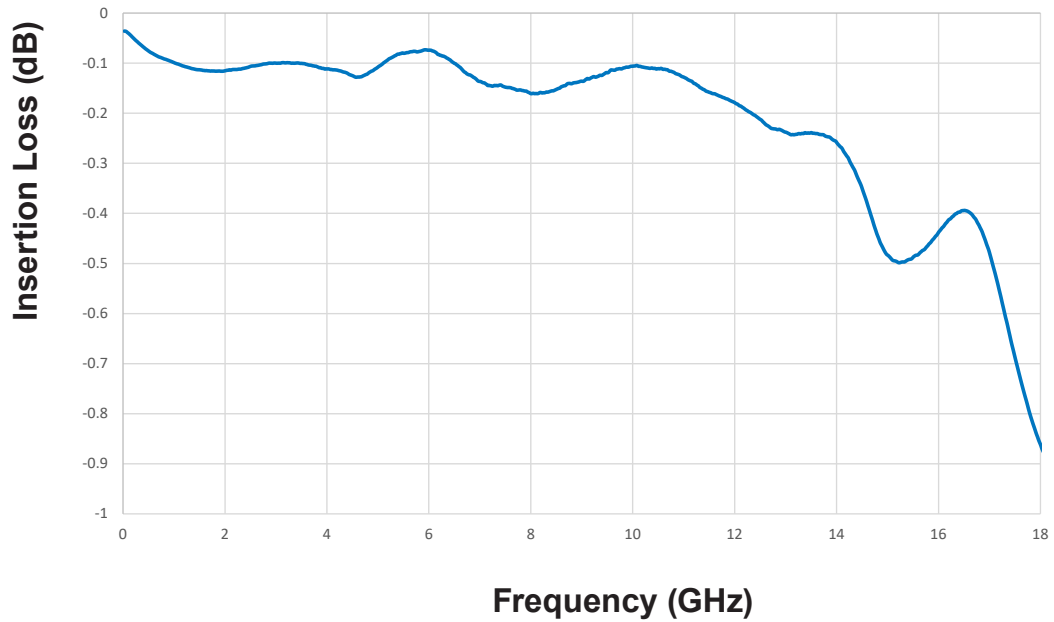

**VSWR**

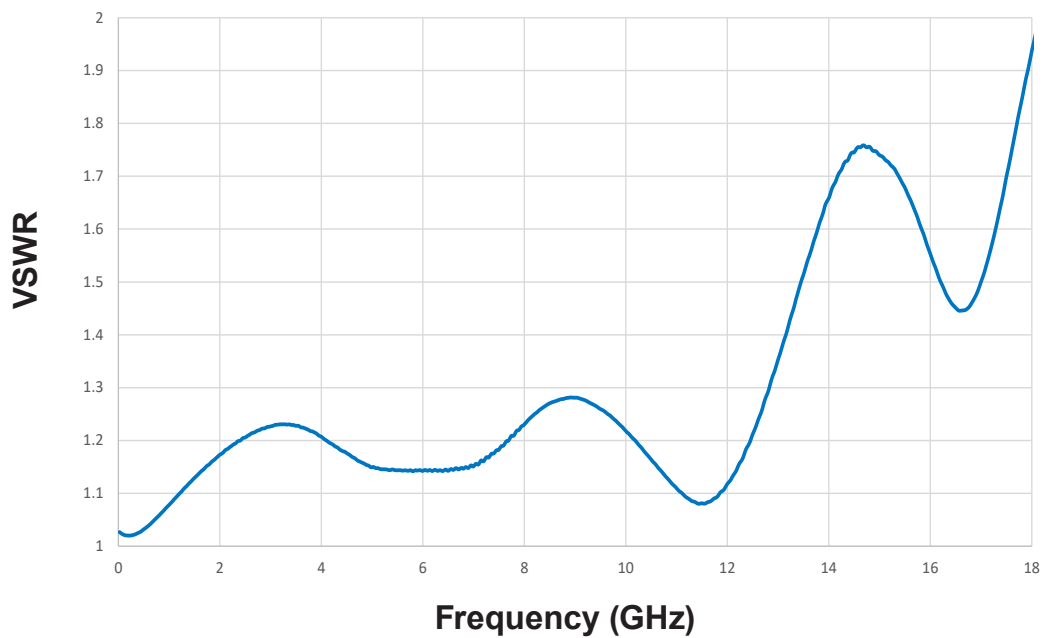

# Series GRF131

SPDT Non-Latching  
DC-18GHz RF Relay  
40Gbps



**TELEDYNE  
RELAYS**

Everywhere you look™

## RF CHARACTERISTICS (See RF Notes)

### Isolation

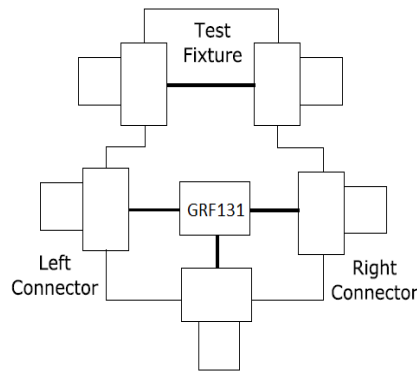
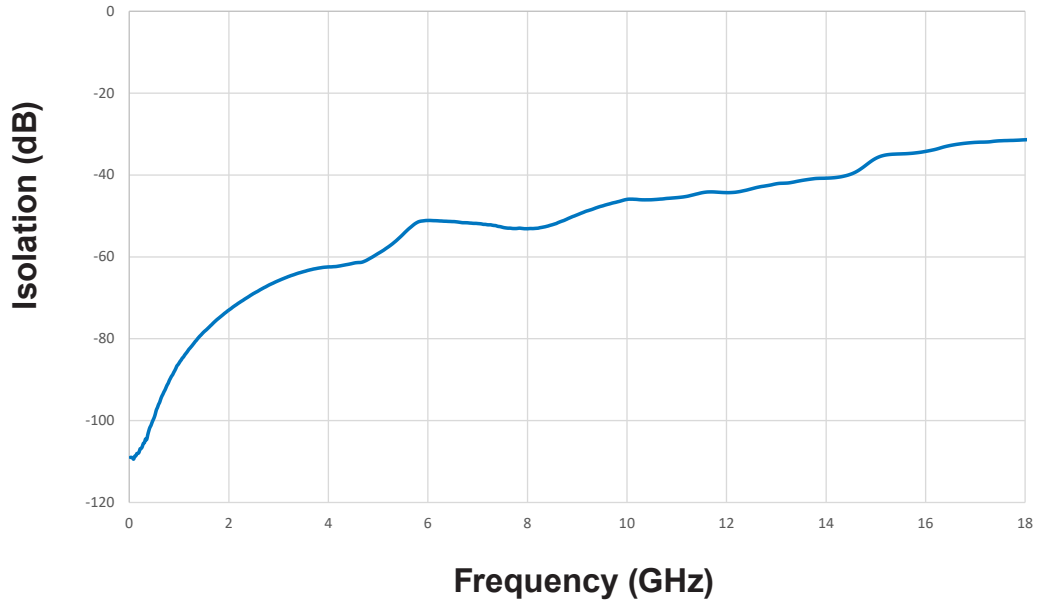

**GRF131 Test Evaluation Board**

### RF NOTES

- Test conditions:
  - Fixture: .031" copper clad, gold plated, reinforced Rogers Corporation 4350B High Frequency Laminate with 2.92mm connectors.
  - Room ambient temperature.
  - Contact power level: 0 dBm.
  - No. of test samples: 2.
- Data presented herein represents typical characteristics and is not intended for use as specification limits.
- Test fixture effect de-embedded from frequency response data.

**SIGNAL INTEGRITY CHARACTERISTICS**

**GRF131@ 16Gbps**

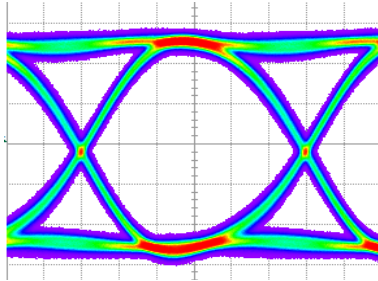

**Reference @ 16Gbps**

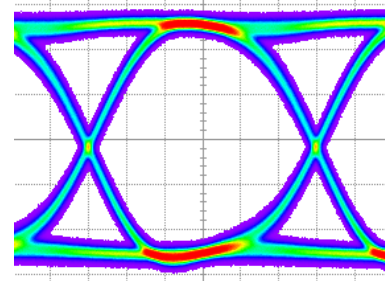

Bit Rate	Eye Height	Eye Width	Jitter <sub>p,p</sub>
16 Gbps	203 mV	49.92 ps	4.99 ps

**GRF131@ 28Gbps**

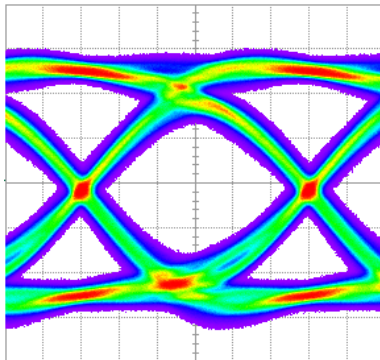

**Reference @ 28Gbps**

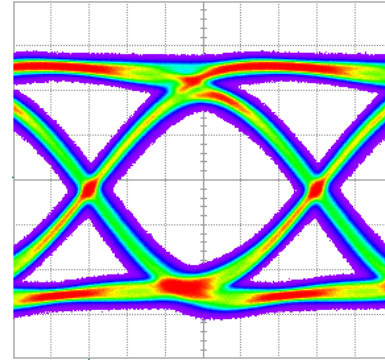

Bit Rate	Eye Height	Eye Width	Jitter <sub>p,p</sub>
28 Gbps	139.2 mV	21.6 ps	5.89 ps

**GRF131 @ 40Gbps**

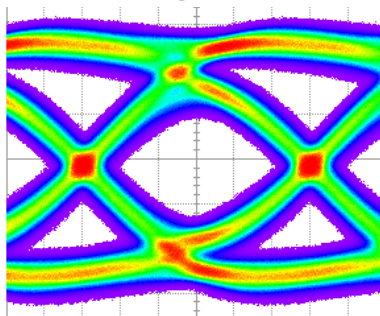

**Reference @ 40Gbps**

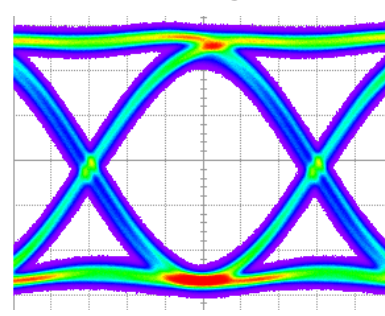

Bit Rate	Eye Height	Eye Width	Jitter <sub>p,p</sub>
40 Gbps	95 mV	13.34 ps	8.73 ps

**Pattern Generator Settings**

- 40 Gbps Random Pulse Pattern Generator
- $2^{31} - 1$  PRBS signal
- PRBS output of 500 mV<sub>p,p</sub> (nominal)
- RF PCB effect (negligible) not removed from measurement
- Data shown is typical of both contacts.
- Data based on GRF121 which has an identical contact system and waveguide

# Series GRF131

SPDT Non-Latching  
DC-18GHz RF Relay  
40Gbps



**TELEDYNE  
RELAYS**

Everywhere you look™

## OUTLINE DIMENSIONS

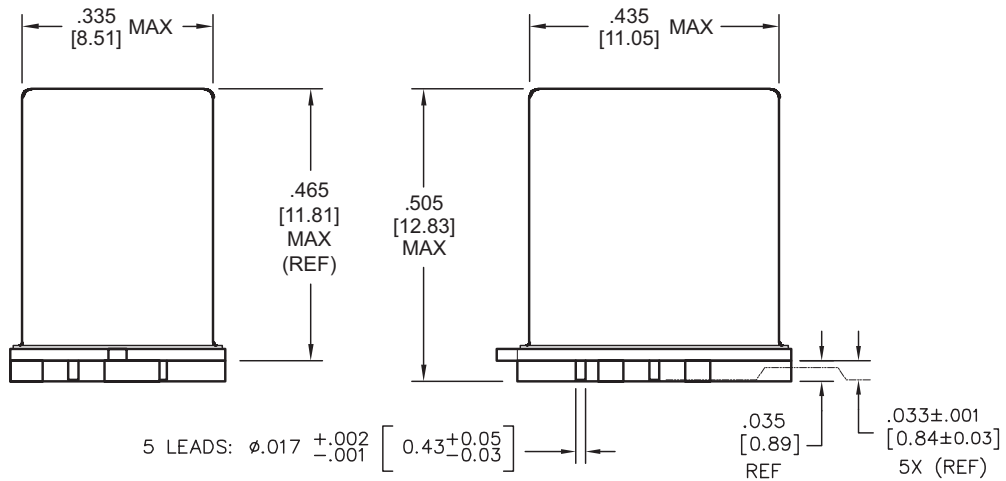

CONTACTS SHOWN IN POSITION RESULTING  
WHEN COIL DE-ENERGIZED

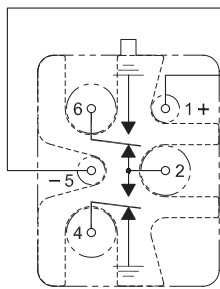

PIN NUMBERS ARE  
FOR REFERENCE  
ONLY, NOT MARKED  
ON RELAY

GRF131

Schematic - Terminal View

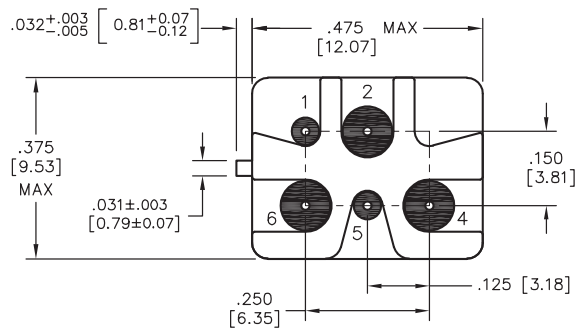

## RECOMMENDED SOLDER STENCIL

