

GRM188R72E102KW07#

"#" indicates a package specification code.



< List of part numbers with package codes >

GRM188R72E102KW07D , GRM188R72E102KW07J

Shape

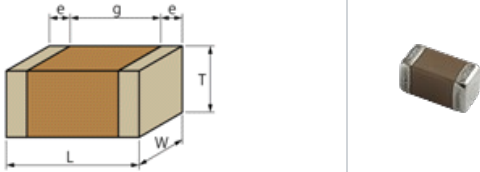

L size	1.6 ±0.1mm
W size	0.8 ±0.1mm
T size	0.8 ±0.1mm
External terminal width e	0.2 to 0.5mm
Distance between external terminals g	0.4mm min.
Size code in inch(mm)	0603 (1608M)

References

Packaging	Specifications	Minimum quantity
D	φ180mm Paper taping	4000
J	φ330mm Paper taping	10000

Mass (typ.)	
1 piece	6.3mg
φ180mm Reel	144g

Specifications

Capacitance	1000pF ±10%
Rated voltage	250Vdc
Temperature characteristics (complied standard)	X7R(EIA)
Capacitance change rate	±15.0%
Temperature range of temperature characteristics	-55 to 125°C
Operating temperature range	-55 to 125°C

⚠ Attention

1.This datasheet is downloaded from the website of Murata Manufacturing Co., Ltd. Therefore, it's specifications are subject to change or our products in it may be discontinued without advance notice. Please check with our sales representatives or product engineers before ordering.

2.This datasheet has only typical specifications because there is no space for detailed specifications.

Therefore, please review our product specifications or consult the approval sheet for product specifications before ordering.

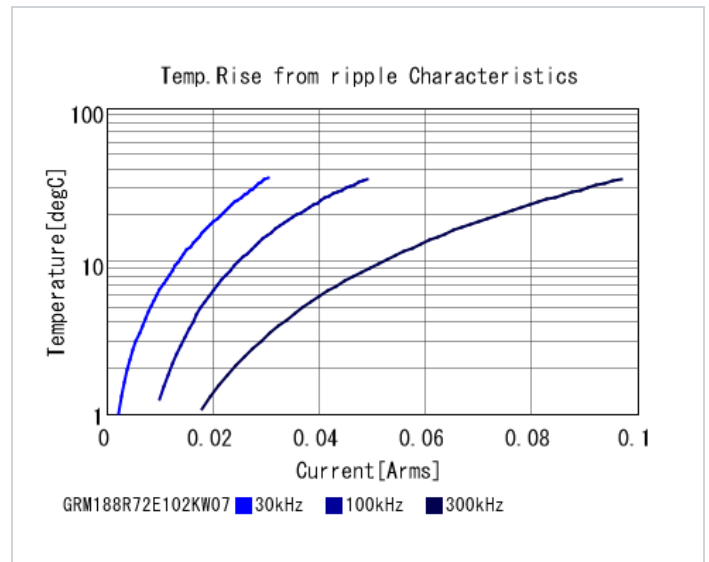
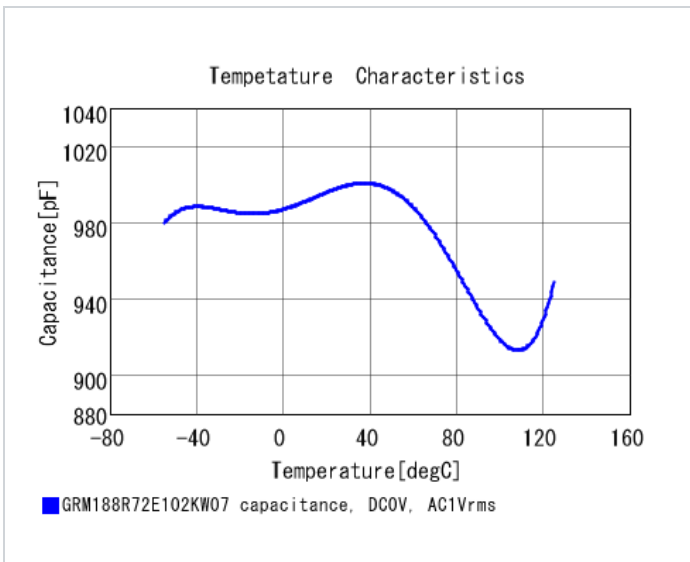
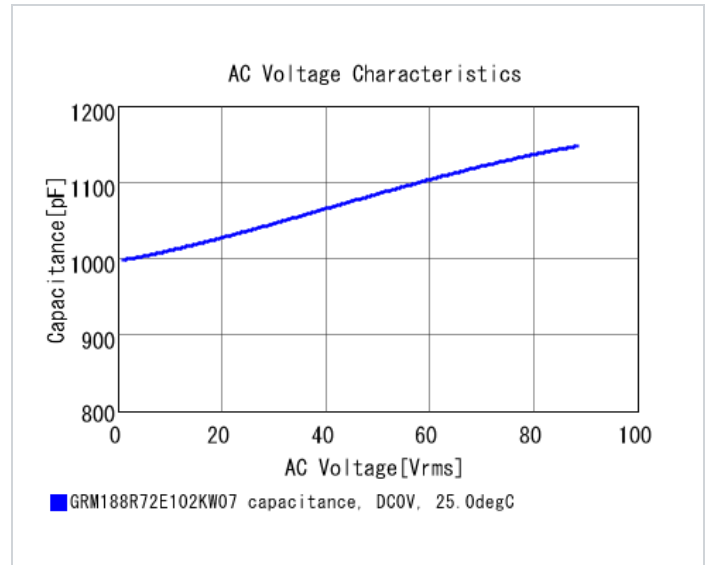
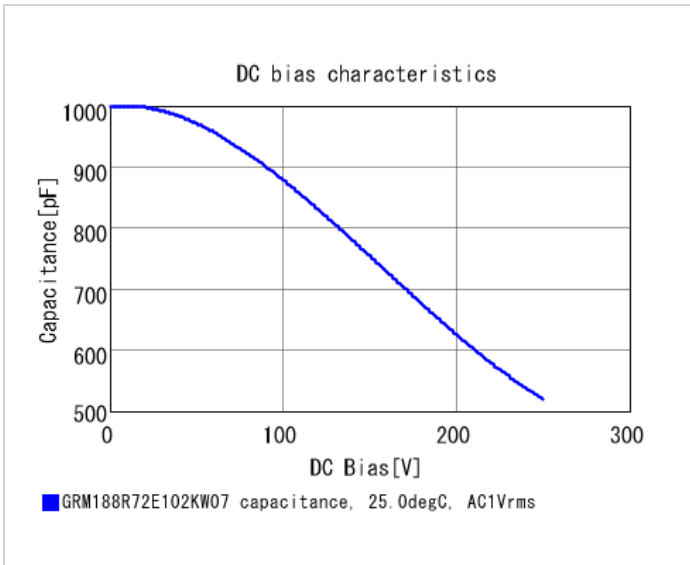
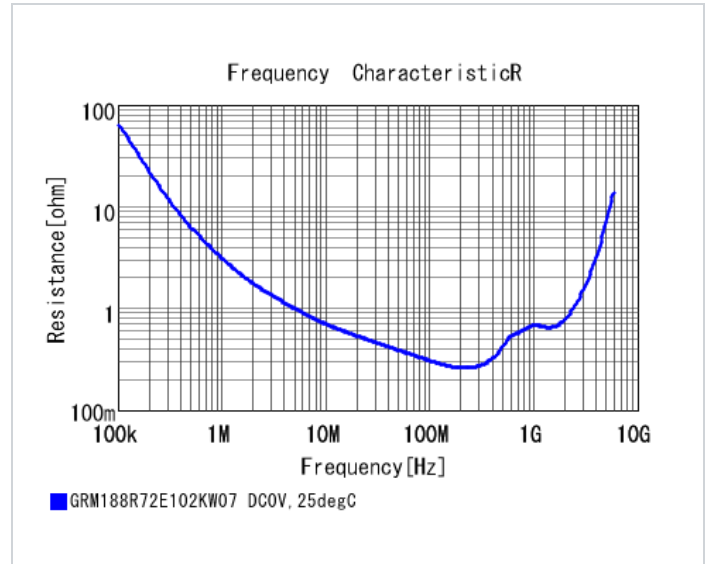
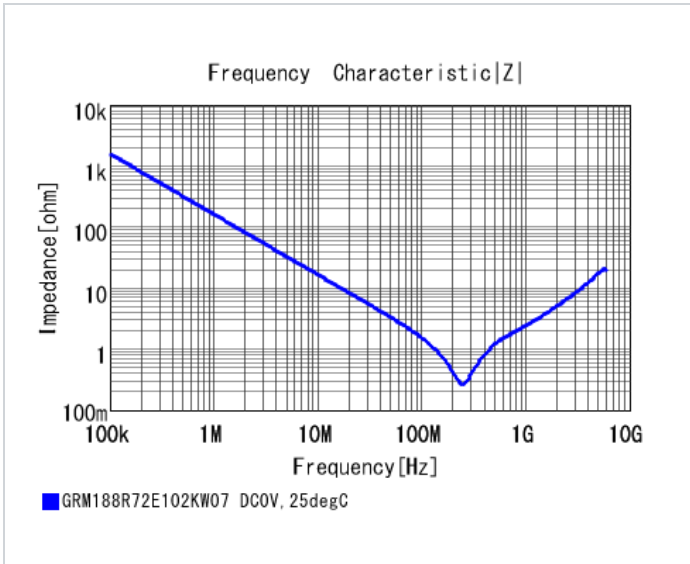

Attention

- 1.This datasheet is downloaded from the website of Murata Manufacturing Co., Ltd. Therefore, it's specifications are subject to change or our products in it may be discontinued without advance notice. Please check with our sales representatives or product engineers before ordering.
- 2.This datasheet has only typical specifications because there is no space for detailed specifications. Therefore, please review our product specifications or consult the approval sheet for product specifications before ordering.