

GRM21BR61E225KA12#

"#" indicates a package specification code.



< List of part numbers with package codes >
 GRM21BR61E225KA12L , GRM21BR61E225KA12K

Shape

L size	2.0 ±0.1mm
W size	1.25 ±0.1mm
T size	1.25 ±0.1mm
External terminal width e	0.2 to 0.7mm
Distance between external terminals g	0.7mm min.
Size code in inch(mm)	0805 (2012M)

Notes

Please use replacements or Recommended.

References

Packaging	Specifications	Minimum quantity
L	φ180mm Embossed taping	3000
K	φ330mm Embossed taping	10000

Mass (typ.)	
1 piece	17mg
φ180mm Reel	102g

Specifications

Capacitance	2.2μF ±10%
Rated voltage	25Vdc
Temperature characteristics (complied standard)	X5R(EIA)
Capacitance change rate	±15.0%
Temperature range of temperature characteristics	-55 to 85°C
Operating temperature range	-55 to 85°C

⚠ Attention

- 1.This datasheet is downloaded from the website of Murata Manufacturing Co., Ltd. Therefore, it's specifications are subject to change or our products in it may be discontinued without advance notice. Please check with our sales representatives or product engineers before ordering.
- 2.This datasheet has only typical specifications because there is no space for detailed specifications. Therefore, please review our product specifications or consult the approval sheet for product specifications before ordering.

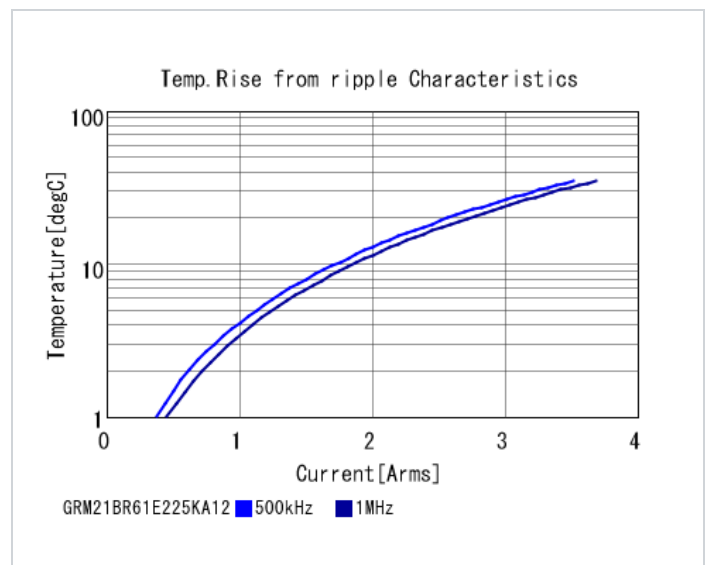
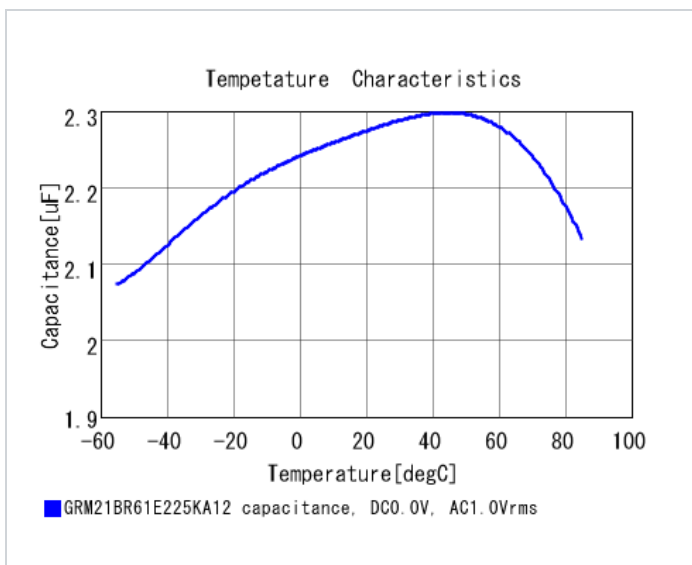
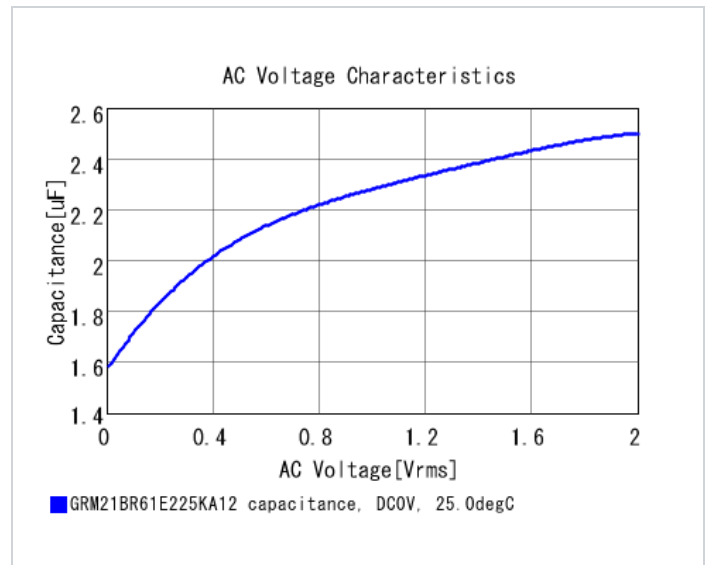
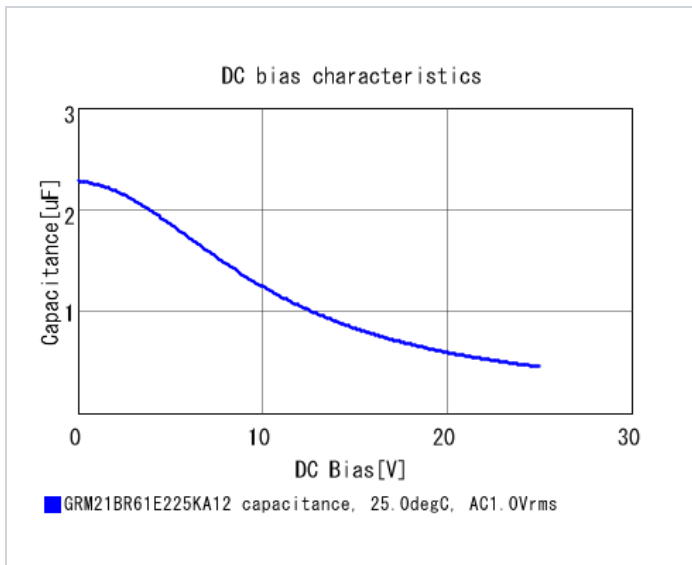
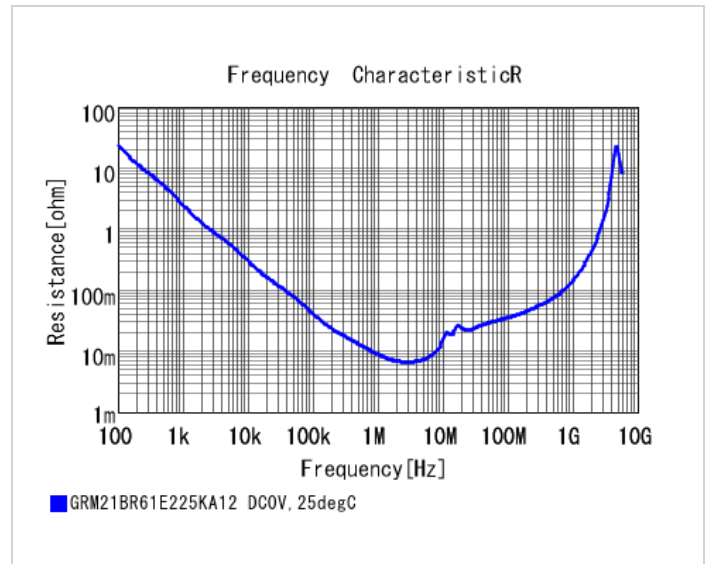
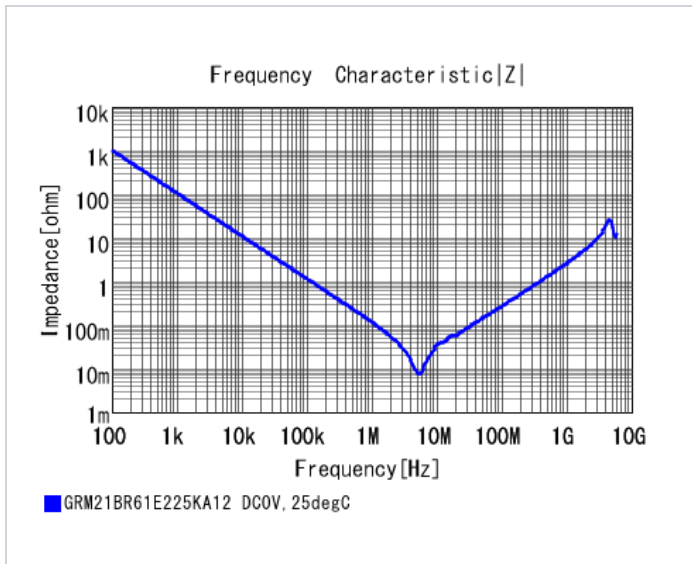

Attention

- 1.This datasheet is downloaded from the website of Murata Manufacturing Co., Ltd. Therefore, it's specifications are subject to change or our products in it may be discontinued without advance notice. Please check with our sales representatives or product engineers before ordering.
- 2.This datasheet has only typical specifications because there is no space for detailed specifications. Therefore, please review our product specifications or consult the approval sheet for product specifications before ordering.