

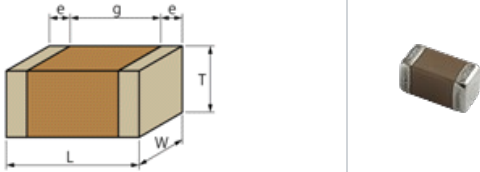

< List of part numbers with package codes >

GRM31BR73A152KW01L , GRM31BR73A152KW01K

## Shape



L size	3.2 ±0.2mm
W size	1.6 ±0.2mm
T size	1.25 +0.0/-0.3mm
External terminal width e	0.3mm min.
Distance between external terminals g	1.2mm min.
Size code in inch(mm)	1206 (3216M)

## References

Packaging	Specifications	Minimum quantity
L	φ 180mm Embossed taping	3000
K	φ 330mm Embossed taping	10000

Mass (typ.)	
1 piece	40mg
φ 180mm Reel	170g

## Specifications

Capacitance	1500pF ±10%
Rated voltage	1000Vdc
Temperature characteristics (complied standard)	X7R(EIA)
Capacitance change rate	±15.0%
Temperature range of temperature characteristics	-55 to 125°C
Operating temperature range	-55 to 125°C

### ⚠ Attention

1.This datasheet is downloaded from the website of Murata Manufacturing Co., Ltd. Therefore, it's specifications are subject to change or our products in it may be discontinued without advance notice. Please check with our sales representatives or product engineers before ordering.

2.This datasheet has only typical specifications because there is no space for detailed specifications.

Therefore, please review our product specifications or consult the approval sheet for product specifications before ordering.

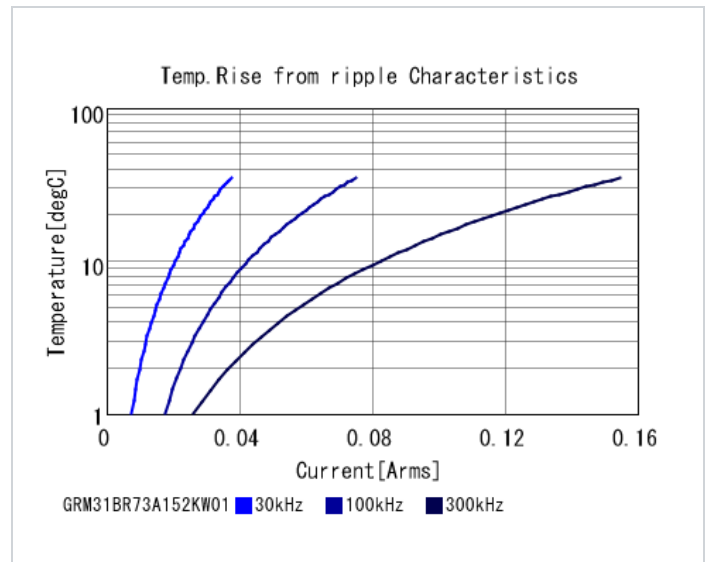
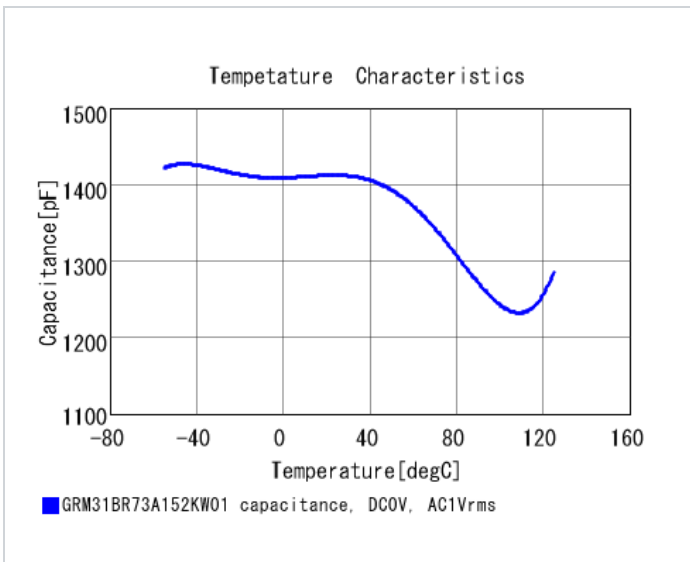
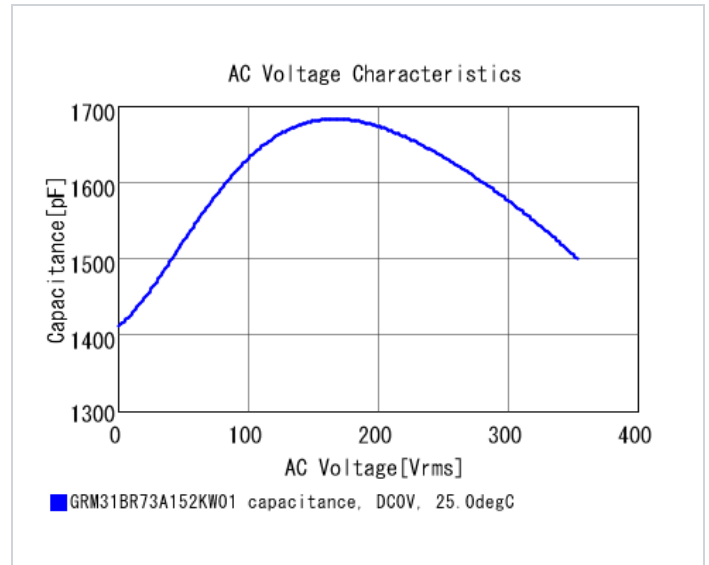
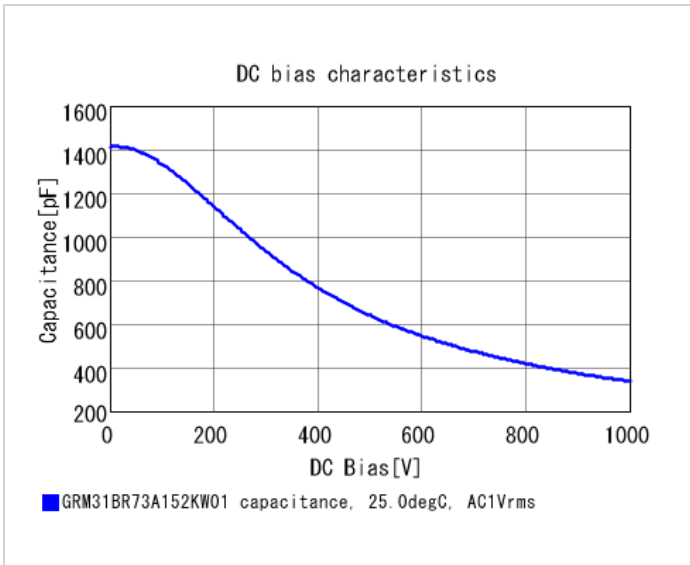
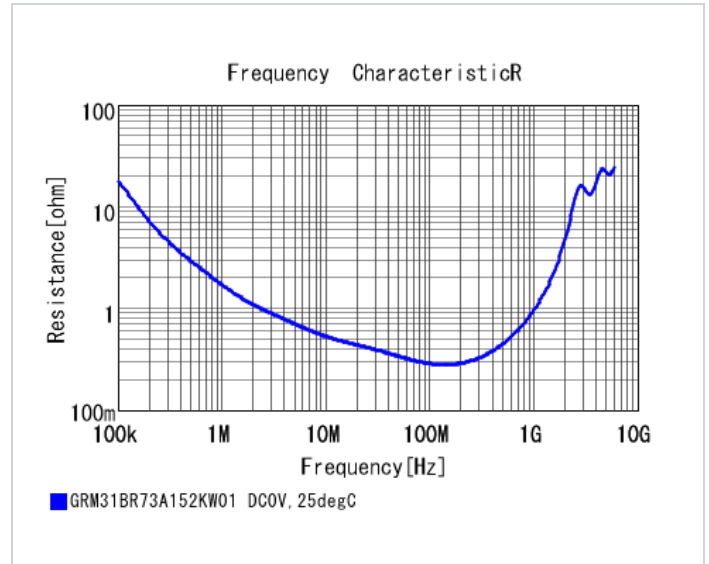
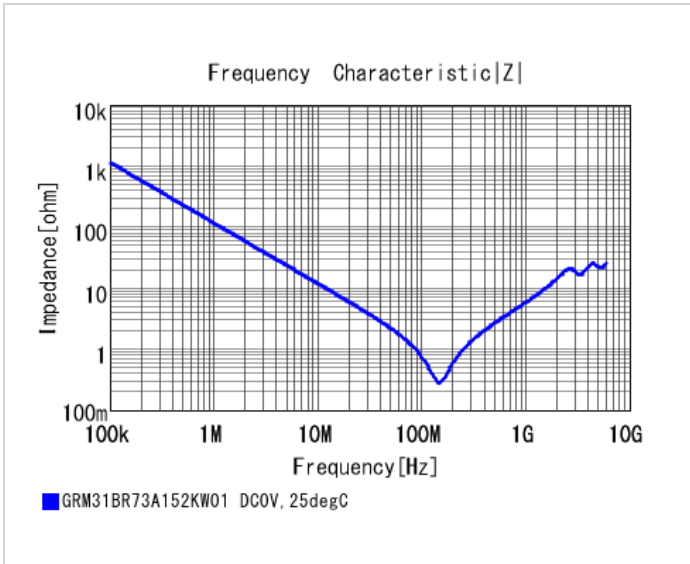

**⚠ Attention**

- 1.This datasheet is downloaded from the website of Murata Manufacturing Co., Ltd. Therefore, it's specifications are subject to change or our products in it may be discontinued without advance notice. Please check with our sales representatives or product engineers before ordering.
- 2.This datasheet has only typical specifications because there is no space for detailed specifications. Therefore, please review our product specifications or consult the approval sheet for product specifications before ordering.