



小型化蕭特基二極管

Voltage Range: 10V-1KV

GS10000FL-GS1010FL

1.0A Surface Mount Glass Passivated Standard Diode

FEATURE:

- ◆ Glass Passivated Die Construction
- ◆ Ideally Suited for Automatic Assembly
- ◆ Low Forward Voltage Drop
- ◆ Surge Overload Rating to 30A Peak
- ◆ Low Profile Package
- ◆ Plastic Material - UL Recognition Flammability Classification 94V-0

Figure SOD-123FL



MECHANICAL CHARACTERISTICS:

- ◆ Case: SOD-123FL Molded Plastic
- ◆ Weight: 0.017 Grams (approx)
- ◆ Marking: Device Part Code
- ◆ Polarity: Cathode Band
- ◆ Terminals: Plated leads solder able per MIL-STD-202, Method 208.
- ◆ Lead Free for Rohm / Lead free version and "LF" suffix to part number.



DIMENSION:

Dimension (mm) SOD-123FL		
Dim.	Min.	Max.
A	3.5	3.7
B	2.65	2.95
C	1.65	1.95
D	0.75	1.05
E	0.1	0.2
G	0.98	1.08
H	0.5	0.8

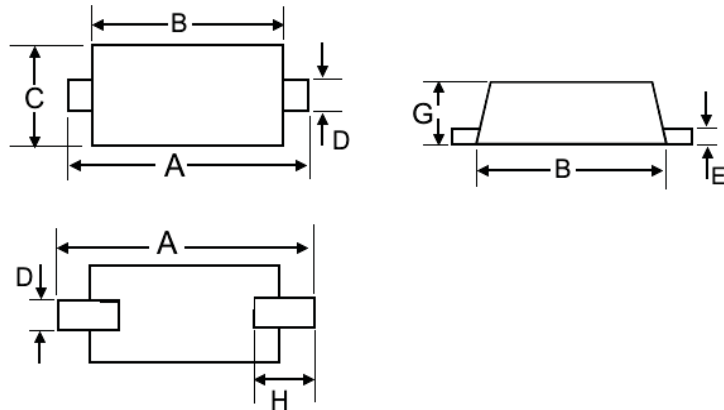

Maximum Ratings @ $T_A=25^{\circ}\text{C}$ unless otherwise specified

Parameter at $T_{amb} = 25^{\circ}\text{C}$	Part Code	GS 1000FL	GS 1001FL	GS 1002FL	GS 1004FL	GS 1006FL	GS 1008FL	GS 1010FL	Unit	
	Symbol	1A	1B	1D	1G	1J	1K	1M		
DC Blocking Voltage:	V_R									
Peak Repetitive Reverse Voltage	V_{RRM}	50	100	200	400	600	800	1000	V	
Working Peak Reverse Voltage	V_{RWM}									
RMS Reverse Voltage	$V_{R(RMS)}$	35	70	140	280	420	560	700	V	
Average Rectified Output Current @ $T_L=75^{\circ}\text{C}$	I_o	1.0								A
Non-Repetitive Peak Forward Surge Current 8.3ms Single half sine-wave superimposed on rated load (JEDC)	I_{FSM}	30								A
Forward Voltage @ $I_F = 1.0\text{A}$	V_{FM}	1.10								V
Peak Reverse Current @ $T_J = 25^{\circ}\text{C}$	I_{RM}	1.0								μA
At Rated DC Blocking Voltage @ $T_J = 125^{\circ}\text{C}$		50								
Reverse Recovery Time (Note ¹)	T_{rr}	2.5								μs
Typical Junction Capacitance (Note ²)	C_j	4.0								pF
Typical Thermal Resistance (Note ³)	$V_{\theta JA}$	65								$^{\circ}\text{C/W}$
Operating and Storage Temperature Range	$T_J, T_{STG.}$	-50 to +150								$^{\circ}\text{C}$

Note¹: Measured with $I_F = 0.5\text{A}$, $I_R = 1.0\text{A}$, $I_{rr} = 0.25\text{A}$

Note²: Measure at 1.0 MHz and applied reverse voltage of 4.0V DC

Note³: Mounted on P.C.Board with 6.0mm² land area.



SINLOON®

小型化蕭特基二極管
Voltage Range: 10V-1KV

GS1000FL-GS1010FL

1.0A Surface Mount Glass Passivated Standard Diode

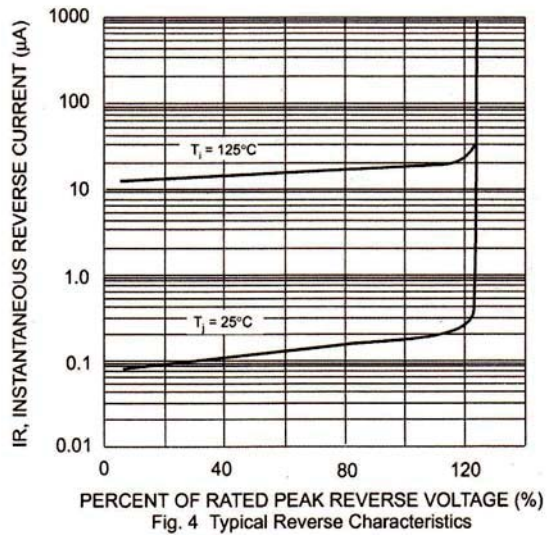
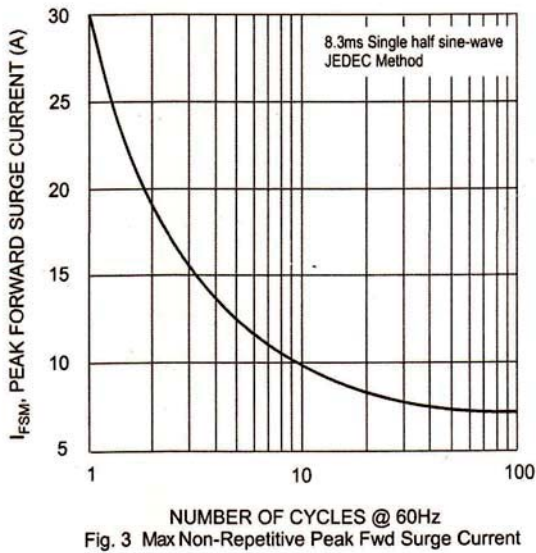
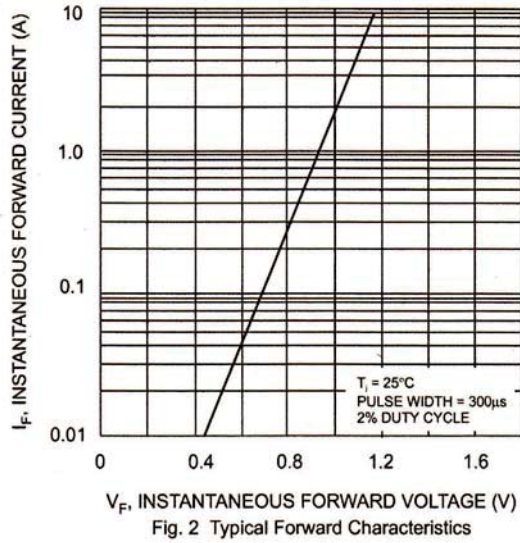
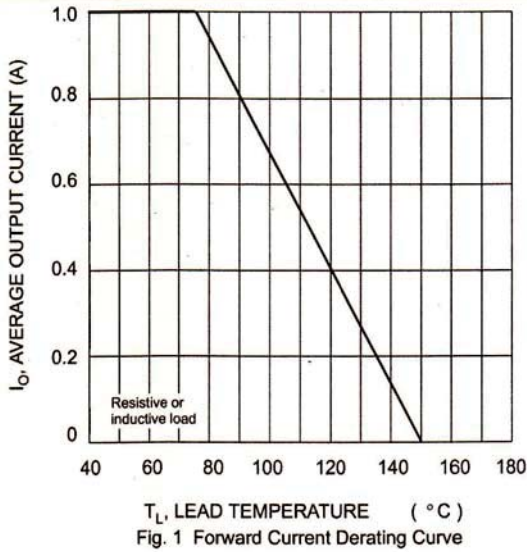

RECOMMENDED SOLDERING PROFILE:

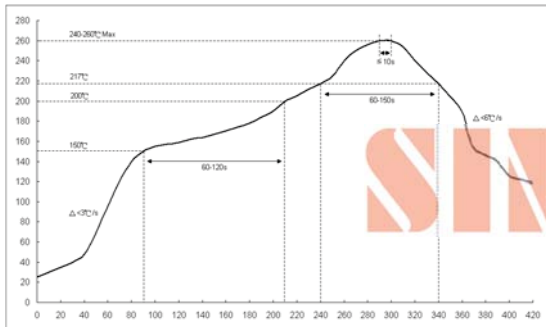

Fig 1: Reflow soldering profile for lead-free solder (SnAgCu)

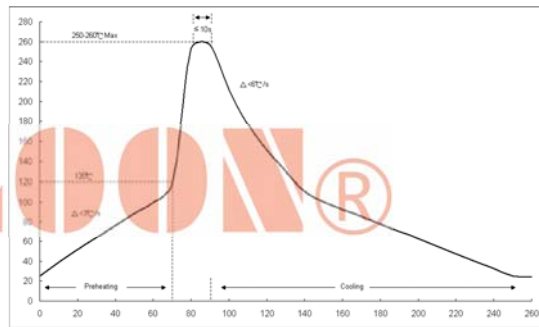

Fig 1: Wave soldering profile.

SINLOON®

小型化蕭特基二極管
Voltage Range: 10V-1KV

GS1000FL-GS1010FL

1.0A Surface Mount Glass Passivated Standard Diode

RECOMMENDED SOLDERING FOOTPRINT

TYPE	Dimension (mm)		
	A	B	C
SOD-123FL	4.25	1.85	1.2

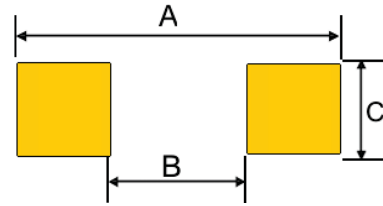

MARKING INFORMATION

Cathode: Polarity Band
Marking: See part code



COMMON PACKING INFORMATION:

Product Number:	Package Type	Packing Quantity	Carton Quantity	Apporx Gross Weight
GS1000FL-GS1010FL	SOD-123FL	3000 Tape & Reel	150,000 Ctn	10 Kg

Reel Diameter (mm)	Quantity (Pcs)	Inner Box Size (mm)	Carton Size (mm)
178	3000	L: 187 x W:187 x H: 65	L:390 x W:240 x H:420

Reel Tape Fig-1

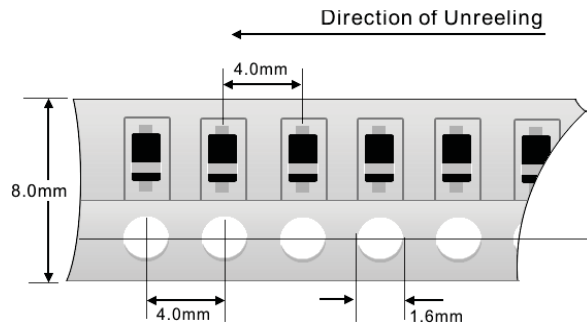

Inner Box Fig-2



Carton



※ 美隆電子產品規格特性參數的改變或更新,將不會另行通知。
 ※ Mayloon characteristic parameters of electronic product specification changes or updates without prior notice。

