

## Surface Mount General Purpose Rectifier

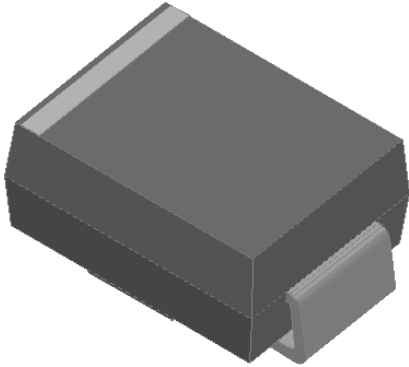

### Features

- Low profile package
- Ideal for automated placement
- Glass passivated chip junction
- High forward surge capability
- Meets MSL level 1, per J-STD-020, LF maximum peak of 260 °C

### Typical Applications

For use in general purpose rectification of power supplies, inverters, converters, and freewheeling diodes for consumer, and telecommunication.

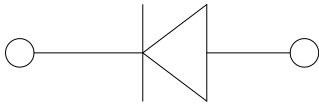

### Mechanical Data

- **Package:** DO-214AA (SMB)  
Molding compound meets UL 94 V-0 flammability rating, RoHS-compliant, halogen-free
- **Terminals:** Tin plated leads, solderable per J-STD-002 and JESD22-B102
- **Polarity:** Cathode line denotes the cathode end

### ■ Maximum Ratings (T<sub>a</sub>=25°C Unless otherwise specified)

PARAMETER	SYMBOL	UNIT	GS3AB	GS3BB	GS3DB	GS3GB	GS3JB	GS3KB	GS3MB
Device marking code			GS3AB	GS3BB	GS3DB	GS3GB	GS3JB	GS3KB	GS3MB
Repetitive peak reverse voltage	VRRM	V	50	100	200	400	600	800	1000
Average rectified output current @60Hz sine wave, resistance load, TL (Fig.1)	I <sub>O</sub>	A	3.0						
Surge(non-repetitive)forward current @ 60Hz half-sine wave, 1 cycle, T <sub>a</sub> =25°C	I <sub>FSM</sub>	A	100						
Storage temperature	T <sub>stg</sub>	°C	-55~+150						
Junction temperature	T <sub>j</sub>	°C	-55~+150						

### ■ Electrical Characteristics (T<sub>a</sub>=25°C Unless otherwise specified)

PARAMETER	SYMBOL	UNIT	TEST CONDITIONS	GS3AB	GS3BB	GS3DB	GS3GB	GS3JB	GS3KB	GS3MB
Maximum instantaneous forward voltage drop per diode	V <sub>F</sub>	V	I <sub>FM</sub> =3.0A	1.15						
Maximum DC reverse current at rated DC blocking voltage per diode @ VRM=VRRM	I <sub>RRM</sub>	μA	T <sub>a</sub> =25°C	10						
			T <sub>a</sub> =125°C	250						



# GS3AB THRU GS3MB

## ■ Thermal Characteristics ( $T_a=25^\circ\text{C}$ Unless otherwise specified)

PARAMETER	SYMBOL	UNIT	GS3AB	GS3BB	GS3DB	GS3GB	GS3JB	GS3KB	GS3MB
Thermal resistance	R $\theta$ J-A	$^\circ\text{C}/\text{W}$	75 <sup>(1)</sup>						
	R $\theta$ J-L		20 <sup>(1)</sup>						

Note  
 (1) Thermal resistance from junction to ambient and from junction to lead mounted on P.C.B. with 0.2" x 0.2" (5.0 mm x 5.0 mm) copper pad areas

## ■ Characteristics (Typical)

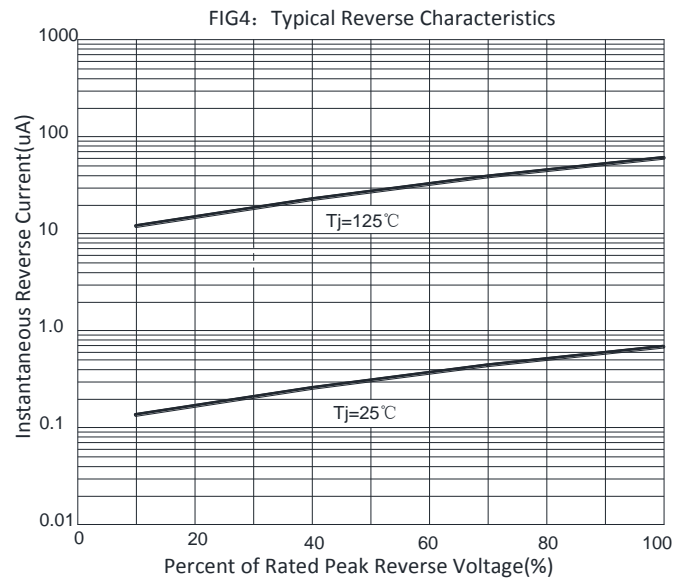
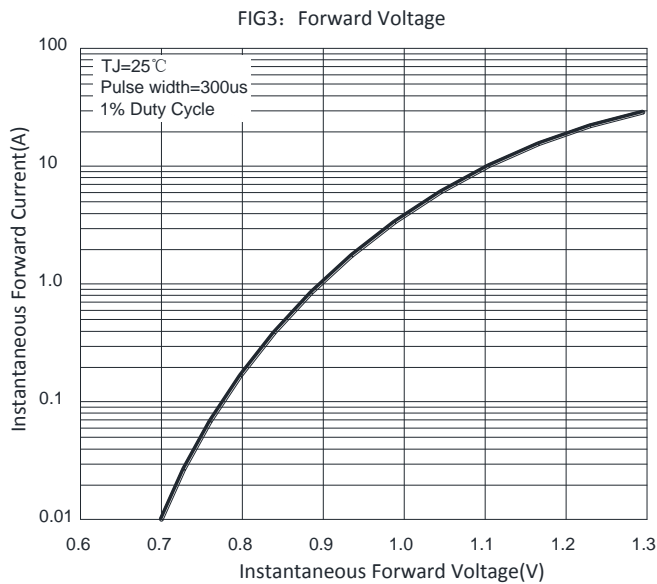
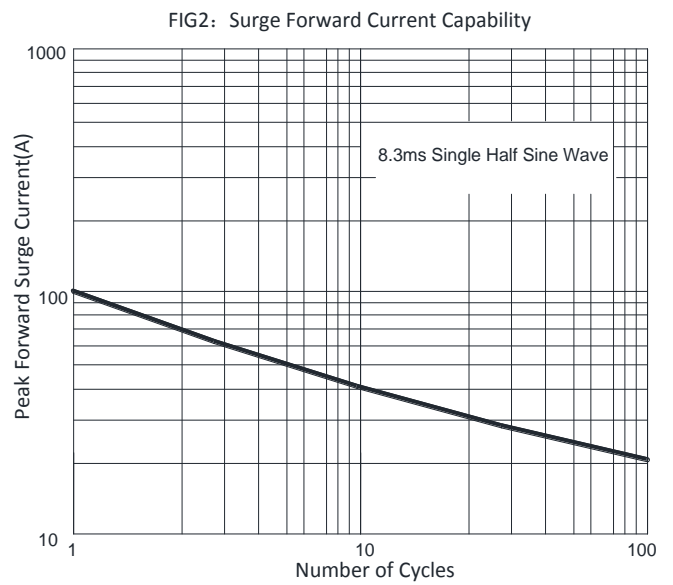
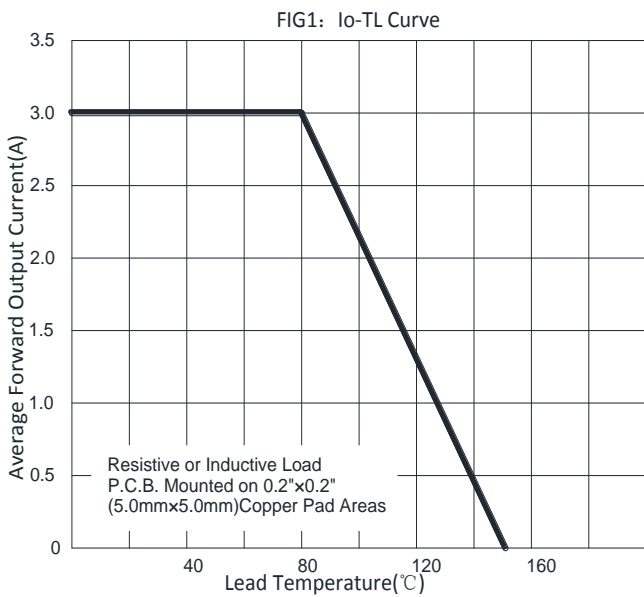



# GS3AB THRU GS3MB

FIG.5: Diagram of circuit and Testing wave form of reverse recovery time

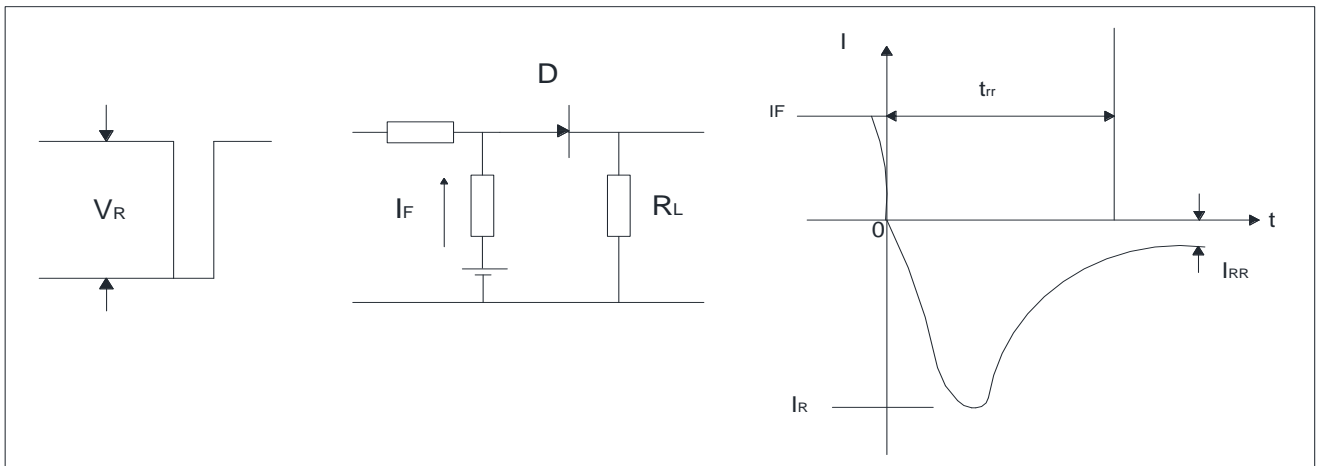

## Ordering Information (Example)

PREFERRED P/N	PACKING CODE	UNIT WEIGHT(g)	MINIMUM PACKAGE(pcs)	INNER BOX QUANTITY(pcs)	OUTER CARTON QUANTITY(pcs)	DELIVERY MODE
GS3AB-GS3MB	F1	Approximate 0.096	3000	6000	48000	13" reel
GS3AB-GS3MB	F2	Approximate 0.096	750	3000	24000	7" reel
GS3AB-GS3MB	F3	Approximate 0.096	500	2000	16000	7" reel

## Outline Dimensions

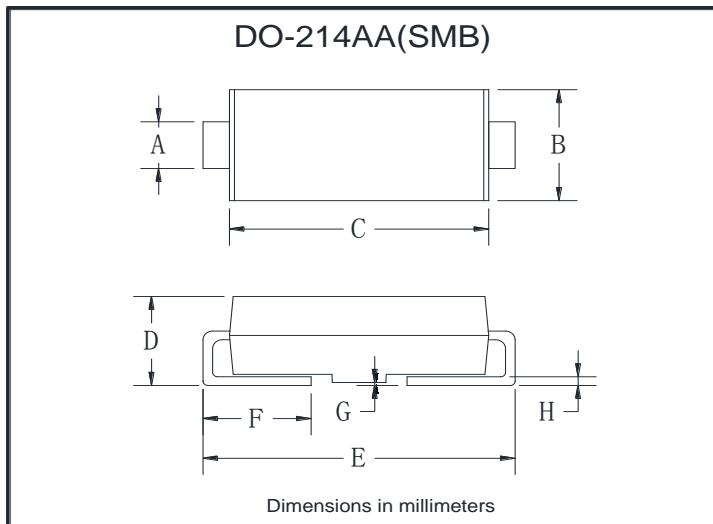

DO-214AA(SMB)		
Dim	Min	Max
A	1.85	2.15
B	3.30	3.94
C	4.25	4.75
D	1.99	2.61
E	5.21	5.59
F	0.90	1.41
G	0.10	0.20
H	0.15	0.31



## GS3AB THRU GS3MB

### ■ Suggested pad layout

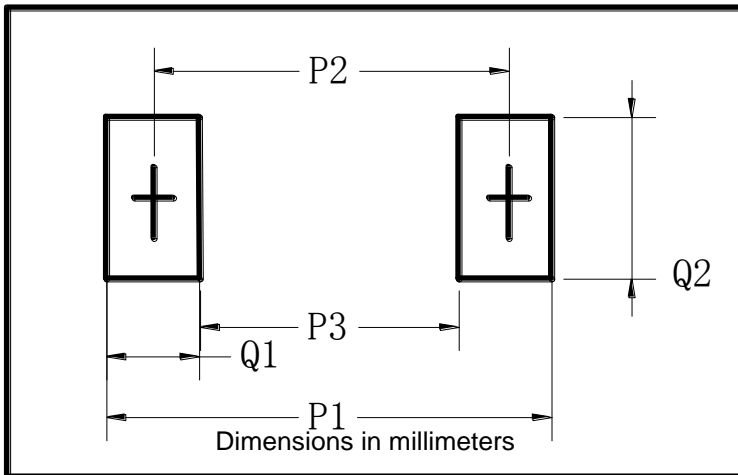

DO-214AA(SMB)	
Dim	Millimeters
P1	6.8
P2	4.3
P3	1.8
Q1	2.5
Q2	2.3



## GS3AB THRU GS3MB

---

### Disclaimer

The information presented in this document is for reference only. Yangzhou Yangjie Electronic Technology Co., Ltd. reserves the right to make changes without notice for the specification of the products displayed herein to improve reliability, function or design or otherwise.

The product listed herein is designed to be used with ordinary electronic equipment or devices, and not designed to be used with equipment or devices which require high level of reliability and the malfunction of which would directly endanger human life (such as medical instruments, transportation equipment, aerospace machinery, nuclear-reactor controllers, fuel controllers and other safety devices), Yangjie or anyone on its behalf, assumes no responsibility or liability for any damages resulting from such improper use of sale.

This publication supersedes & replaces all information previously supplied. For additional information, please visit our website [http:// www.21yangjie.com](http://www.21yangjie.com) , or consult your nearest Yangjie's sales office for further assistance.