

# GS5256

## 150KHz 3A Step-Down Voltage Regulator

### Product Description

The GS5256 series regulators are monolithic integrated circuits that provide all the active functions for a step-down switching regulator; capable of driving a 3A load with excellent line and load regulation. These devices are available in fixed output voltages of 3.3V, 5V and an adjustable output version.

Requiring a minimum number of external components, these regulators are simple to use and include internal frequency compensation, and a fixed-frequency oscillator.

The GS5256 series operates at a switching frequency of 150 kHz thus allowing smaller sized filter components than what would be needed with lower frequency switching regulators. Available in a standard 5-lead TO-220 package and a 5-lead TO-263 surface mount package.

A standard series of inductors are optimized for use with the GS5256 series. This feature greatly simplifies the design of switch-mode power supplies.

Other features include a guaranteed  $\pm 4\%$  tolerance on output voltage under specified input voltage and output load conditions, and  $\pm 15\%$  on the oscillator frequency. External shutdown is included, featuring typically 80 $\mu$ A standby current. Self-protection features include a two stage frequency reducing current limit for the output switch and an over temperature shutdown for complete protection under fault conditions.

### Features

- 3.3V, 5V and adjustable output versions
- Adjustable version output voltage range, 1.2V to 37V
- $\pm 4\%$  max over line and load conditions
- Guaranteed 3A output load current
- Requires only 4 external components
- Excellent line and load regulation specifications
- 150kHz fixed frequency internal oscillator
- TTL shutdown capability
- Low power standby mode,  $I_Q$  typically 80 $\mu$ A
- High efficiency
- Uses readily available standard inductors
- Thermal shutdown and current limit protection
- Available in TO-220-5 and TO-263-5 packages
- RoHS Compliant, 100%Pb & Halogen Free

### Applications

- Efficient pre-regulator for linear regulator
- Simple high-efficiency step-down regulator
- On-card switching regulators
- Positive to negative converter

### Block Diagram

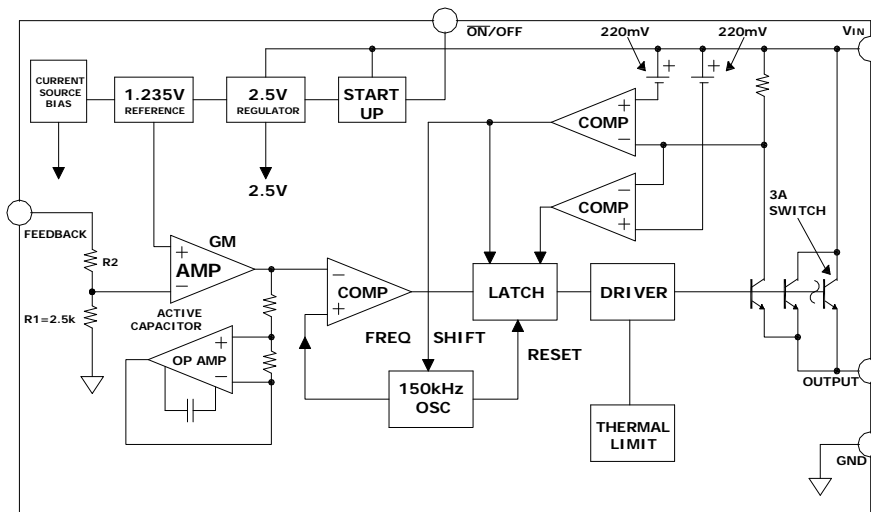

## Packages & Pin Assignments

GS5256TF (TO-220-5)		GS5256MF (TO-263-5)	
1	Input	1	Input
2	Output	2	Output
3	Ground	3	Ground
4	Feedback	4	Feedback
5	ON/OFF	5	ON/OFF

## Ordering Information

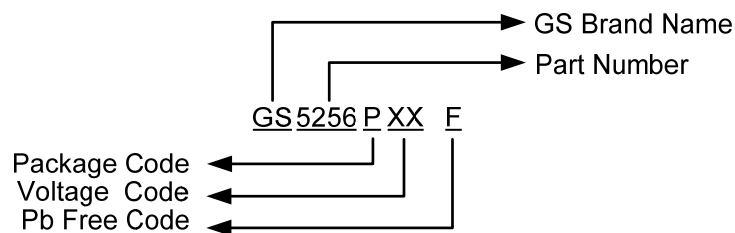

\*For other voltages, please contact factory.

Package Type		Output Voltage
TO-220	TO-263	
GS5256TF	GS5256MF	ADJ
GS5256T33F	GS5256M33F	3.3V
GS5256T50F	GS5256M50F	5.0V

## Marking Information

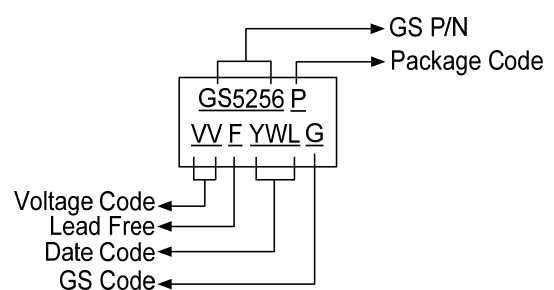
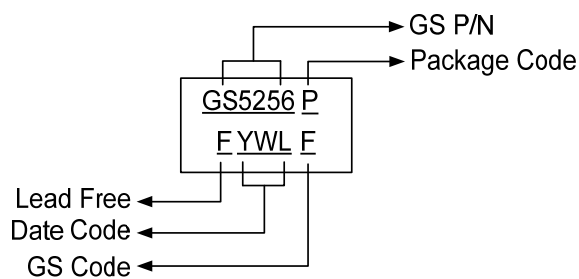

## Absolute Maximum Rating

Parameter	Maximum	Unit	
Maximum Supply Voltage	40	V	
ON /OFF Pin Input Voltage	$-0.3 \leq V \leq +25$	V	
Feedback Pin Voltage	$-0.3 \leq V \leq +25$	V	
Output Voltage to Ground (Steady State)	-1	V	
Storage Temperature Range	-65 to +150	°C	
Maximum Junction Temperature	+150	°C	
Lead Temperature (Soldering, 10 Seconds)	260	°C	
Minimum ESD Rating (C=100pF, R=1.5KΩ)	2	kV	
Power Dissipation (Internally limited ), $P_D$	TO-220	2	W
	TO-263	2	
Thermal Resistance (Junction to Ambient), $\theta_{JA}$	TO-220	62.5	°C/W
	TO-263	62.5	

### Note:

Stresses above those listed under “Absolute Maximum Ratings” may cause permanent damage to the device. These are stress ratings only and functional operation of the device at these or any other conditions above those indicated in the operation sections of the specifications is not implied.

Exposure to Absolute Maximum Ratings conditions for extended periods may affect device reliability.

### Operating Ratings

Parameter	Value	Unit
Temperature Range	$-40 \leq T_J \leq +125$	°C
Supply Voltage	4.5 to 40	V

## Electrical Characteristics

### GS5256-3.3

Symbol	Parameter	Conditions	MIN	TYP	MAX	Unit
$V_{OUT}$	Output Voltage	$4.75V \leq V_{IN} \leq 40V, 0.2A \leq I_{LOAD} \leq 3A$ (Note 3,4)				
		$T_J = 25^\circ C$	3.168	3.3	3.432	V
		$T_J = -40^\circ C$ to $125^\circ C$	3.135	3.3	3.465	V
$\eta$	Efficiency	$V_{IN} = 12V, I_{LOAD} = 3A$		73		%

### GS5256-5.0

Symbol	Parameter	Conditions	MIN	TYP	MAX	Unit
$V_{OUT}$	Output Voltage	$7V \leq V_{IN} \leq 40V, 0.2A \leq I_{LOAD} \leq 3A$ (Note 3,4)				
		$T_J = 25^\circ C$	4.80	5.0	5.2	V
		$T_J = -40^\circ C$ to $125^\circ C$	4.75	5.0	5.25	V
$\eta$	Efficiency	$V_{IN} = 12V, I_{LOAD} = 3A$		80		%

### GS5256-ADJ

Symbol	Parameter	Conditions	MIN	TYP	MAX	Unit
$V_{OUT}$	Output Voltage	$4.5V \leq V_{IN} \leq 40V, 0.2A \leq I_{LOAD} \leq 3A$ $V_{OUT}$ programmed for 3V, Circuit of Figure 1.				
		$T_J = 25^\circ C$	1.193	1.23	1.267	V
		$T_J = -40^\circ C$ to $125^\circ C$	1.180	1.23	1.280	V
$\eta$	Efficiency	$V_{IN} = 12V, I_{LOAD} = 3A, V_{OUT} = 3V$		73		%

## Electrical Characteristics (Continued)

Unless otherwise specified,  $V_{IN} = 12V$  for the 3.3V, 5V, and Adjustable version,  $I_{LOAD} = 500mA$ .

Symbol	Parameter	Conditions	MIN	TYP	MAX	Unit
<b>Device Parameters</b>						
$I_B$	Feedback Bias Current	$V_{FB}=1.3V$ (Adjustable Version Only)				
		$T_J=25\text{ }^\circ\text{C}$	-	10	50	nA
		$T_J=-40\text{ }^\circ\text{C}$ to $125\text{ }^\circ\text{C}$	-	-	100	nA
$F_{OSC}$	Oscillator Frequency	$T_J=25\text{ }^\circ\text{C}$ (Note 6)	-	150	-	kHz
		$T_J=0\text{ }^\circ\text{C}$ to $125\text{ }^\circ\text{C}$	127	-	173	kHz
		$T_J=-40\text{ }^\circ\text{C}$ to $125\text{ }^\circ\text{C}$	110	-	173	kHz
$V_{SAT}$	Saturation Voltage	$I_{OUT}=3A$ (Note 7,8)				
		$T_J=25\text{ }^\circ\text{C}$	-	1.16	1.4	V
		$T_J=-40\text{ }^\circ\text{C}$ to $125\text{ }^\circ\text{C}$	-	-	1.5	V
DC	Max Duty Cycle (ON)	(Note 8)	-	100	-	%
	Min Duty Cycle (OFF)	(Note 9)	-	0	-	%
$I_{CL}$	Current Limit	Peak Current (Notes 7, 8)				
		$T_J=25\text{ }^\circ\text{C}$	3.6	4.5	6.9	A
		$T_J=-40\text{ }^\circ\text{C}$ to $125\text{ }^\circ\text{C}$	3.4	4.5	7.5	A
$I_L$	Output Leakage Current	Output = 0V (Notes 7,8)	-	-	50	$\mu\text{A}$
		Output = -1V (Notes 10)	-	2	30	mA
$I_Q$	Quiescent Current	(Note 9)	-	5	10	mA
$I_{STBY}$	Standby Quiescent Current	ON/OFF Pin=5V(OFF), (Notes 10)	-	80	200	$\mu\text{A}$
<b>ON/OFF Control</b>						
$V_{IH}$	ON/OFF Pin Logic Input	Low (Regulator ON)	-	1.3	0.6	V
$V_{IL}$	Threshold Voltage	High (Regulator OFF)	2.0	1.3	-	V
$I_{IH}$	ON/OFF Pin Input Current	$V_{LOGIC} = 2.5V$ (Regulator OFF)		5	15	$\mu\text{A}$
$I_{IL}$		$V_{LOGIC} = 0.5V$ (Regulator ON)		0.02	5	$\mu\text{A}$

- Note 1** Absolute Maximum Ratings indicate limits beyond which damage to the device may occur. Operating Ratings indicate conditions for which the device is intended to be functional, but do not guarantee specific performance limits. For guaranteed specifications and test conditions, see the Electrical Characteristics.
- Note 2** The human body model is a 100pF capacitor discharged through a 1.5k resistor into each pin.
- Note 3** Typical numbers are at 25°C and represent the most likely norm.
- Note 4** All limits guaranteed at room temperature (standard type face) and at temperature extremes (bold type face). All room temperature limits are 100% production tested. All limits at temperature extremes are guaranteed via correlation using standard Statistical Quality Control (SQC) methods. All limits are used to calculate Average Outgoing Quality Level (AOQL).
- Note 5** External components such as the catch diode, inductor, input and output capacitors, and voltage programming resistors can affect switching regulator system performance. When the GS5256 is used as shown in the Figure 1 test circuit, system performance will be as shown in system parameters section of Electrical Characteristics.
- Note 6** The switching frequency is reduced when the second stage current limit is activated. The amount of reduction is determined by the severity of current over-load.
- Note 7** No diode, inductor or capacitor connected to output pin.
- Note 8** Feedback pin removed from output and connected to 0V to force the output transistor switch ON.
- Note 9** Feedback pin removed from output and connected to 12V for the 3.3V, 5V, and the ADJ. version, and 15V for the 12V version, to force the output transistor switch OFF.
- Note10**  $V_{IN} = 40V$
- Note11** Junction to ambient thermal resistance (no external heat sink) for the TO-220 package mounted vertically, with the leads soldered to a printed circuit board with (1 oz.) copper area of approximately 1 in<sup>2</sup>
- Note12** Junction to ambient thermal resistance with the TO-263 package tab soldered to a single printed circuit board with 0.5 in<sup>2</sup> of (1 oz.) copper area.

**Note13** Junction to ambient thermal resistance with the TO-263 package tab soldered to a single sided printed circuit board with 2.5 in<sup>2</sup> of (1 oz.) copper area.

**Note14** Junction to ambient thermal resistance with the TO-263 package tab soldered to a double sided printed circuit board with 3 in<sup>2</sup> of (1 oz.) copper area on the GS5256S side of the board, and approximately 16 in<sup>2</sup> of copper on the other side of the p-c board.

## Typical Performance Characteristics

**Normalized Output Voltage**

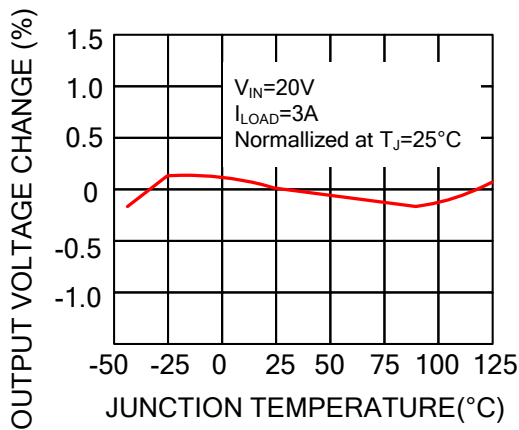

**Line Regulation**

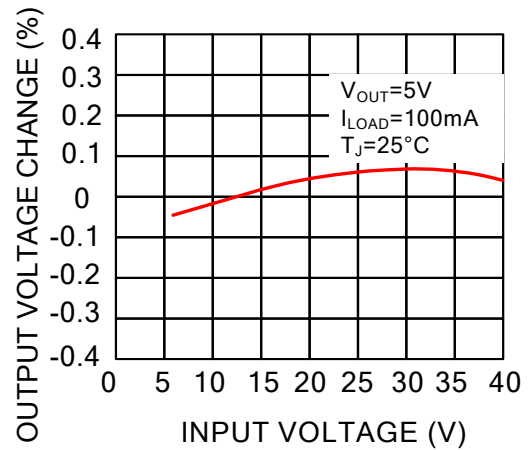

**Efficiency**

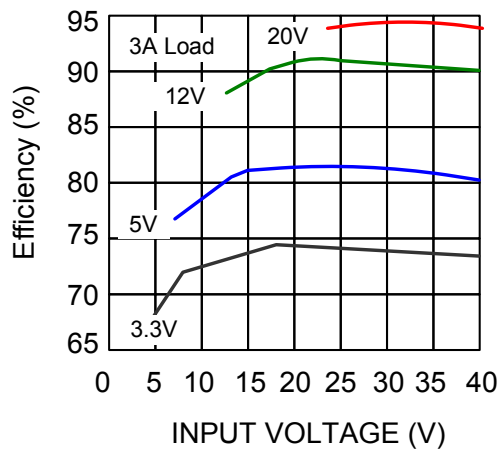

**Switch Saturation Voltage**

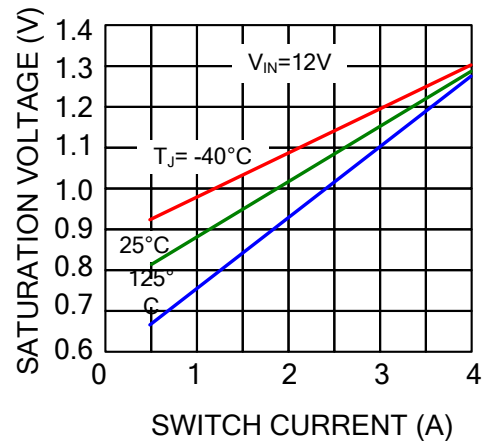

**Switch Current Limit**

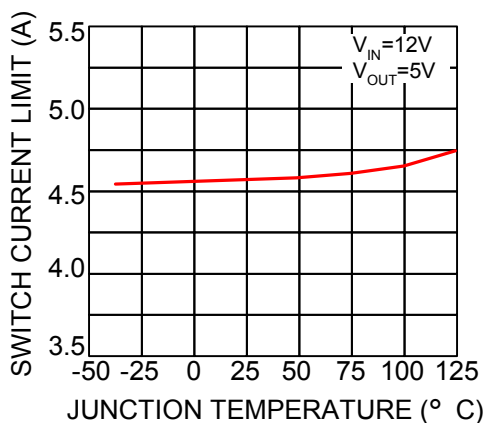

**Dropout Voltage**

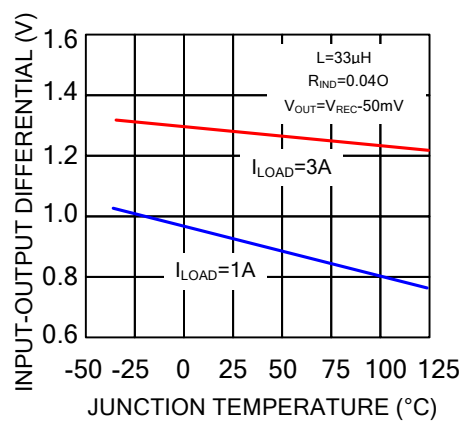

### Operating Quiescent Current

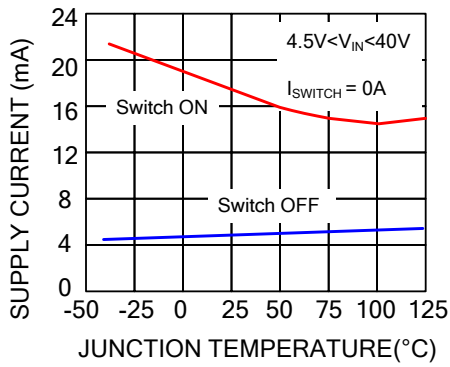

### Shutdown Quiescent Current

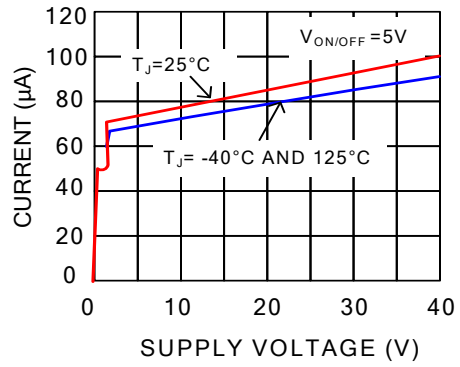

### Minimum Operating Supply Voltage

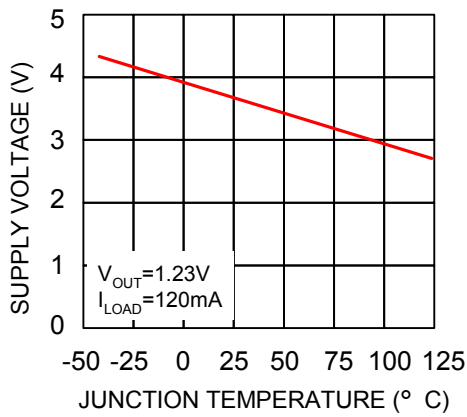

### ON/OFF Threshold Voltage

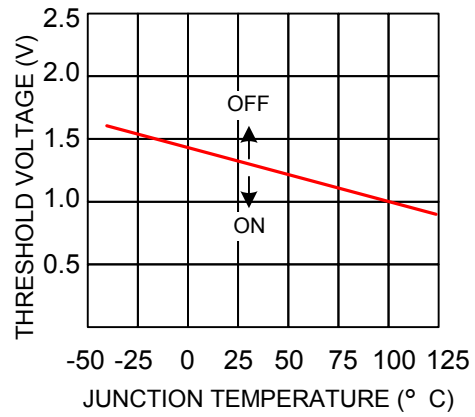

### ON/OFF Pin Current (Sinking)

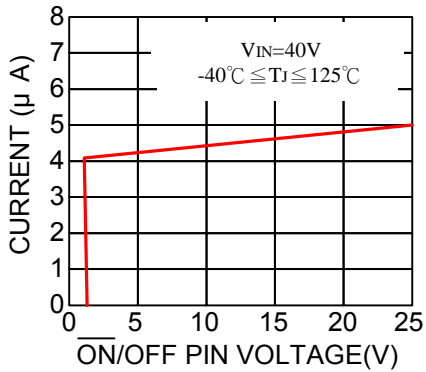

### Switching Frequency

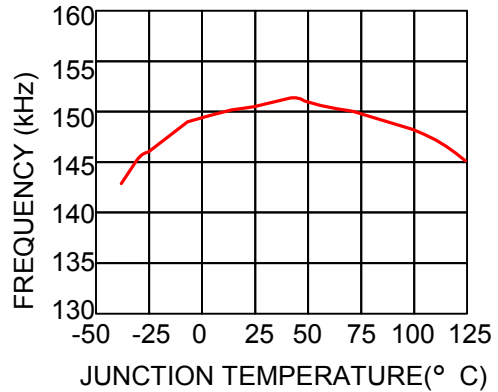

### Feedback Pin Bias Current

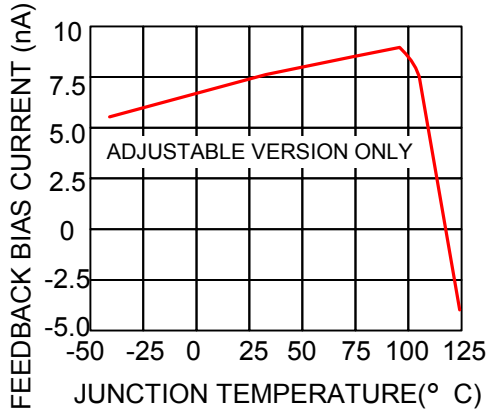

## Test Circuit and Layout Guidelines

### Fixed Output Voltage Versions

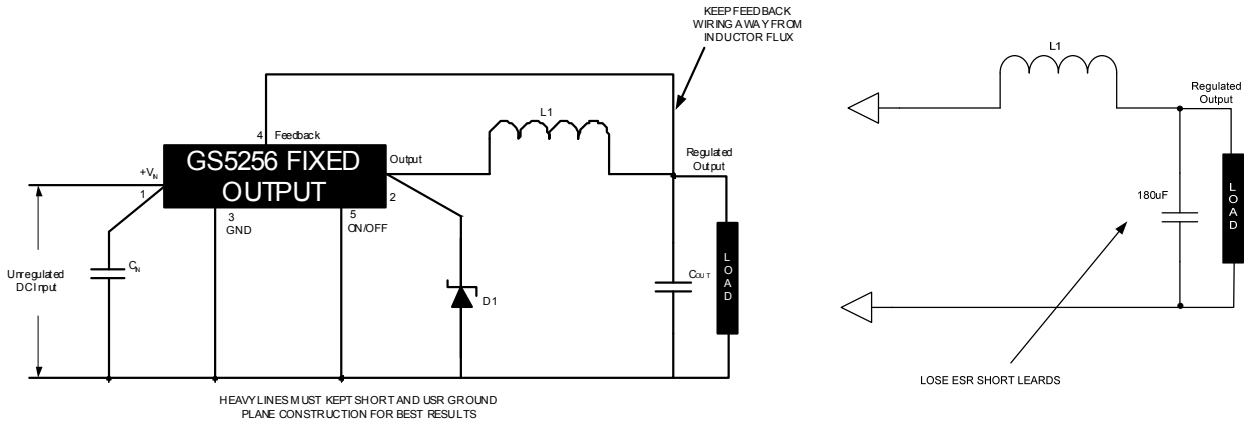

### Adjustable Output Voltage Versions

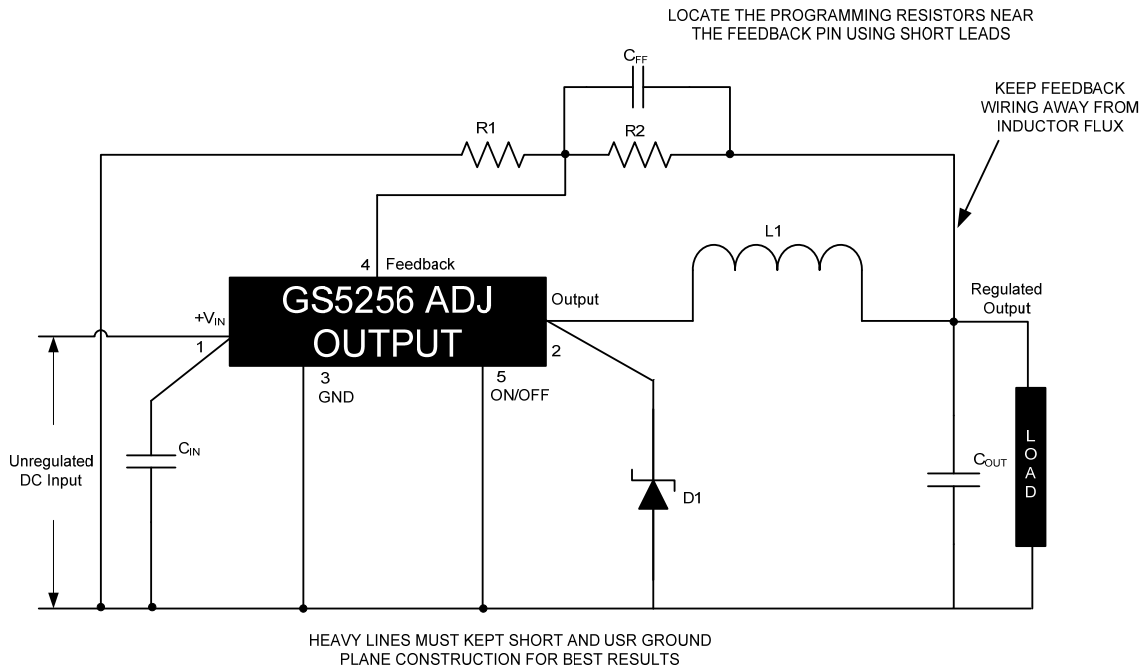

$$V_{OUT} = V_{REF} \left( 1 + \frac{R_2}{R_1} \right)$$

Where  $V_{REF} = 1.23V$

$$R_2 = R_1 \left( \frac{V_{OUT}}{V_{REF}} - 1 \right)$$

## GS5256 Design Procedure (Fixed Output)

### PROCEDURE (Fixed Output Voltage Version)

#### Given:

$V_{OUT}$  = Regulated Output Voltage (3.3V, 5V, 12V)

$V_{IN}(\text{max})$  = Maximum DC Input Voltage

$I_{LOAD}(\text{max})$  = Maximum Load Current

#### 1. Inductor Selection (L1)

- Select the correct inductor value selection guide. (Output voltages of 3.3V, 5V, or 12V respectively.) For all other voltages, see the design procedure for the adjustable version.
- From the inductor value selection guide, identify the inductance region intersected by the Maximum Input Voltage line and the Maximum Load Current line. Each region is identified by an inductance value and an inductor code (LXX).
- Select an appropriate inductor from the four manufacturer's part numbers listed.

#### 2. Output Capacitor Selection ( $C_{OUT}$ )

- In the majority of applications, low ESR (Equivalent Series Resistance) electrolytic capacitors between 82 $\mu$ F and 820 $\mu$ F and low ESR solid tantalum capacitors between 10 $\mu$ F and 470 $\mu$ F provide the best results. This capacitor should be located close to the IC using short capacitor leads and short copper traces. Do not use capacitors larger than 820 $\mu$ F.
- To simplify the capacitor selection procedure, refer to the quick design component selection table shown in Figure 2. This table contains different input voltages, output voltages, and load currents, and lists various inductors and output capacitors that will provide the best design solutions.
- The capacitor voltage rating for electrolytic capacitors should be at least 1.5 times greater than the output voltage, and often much higher voltage ratings are needed to satisfy the low ESR requirements for low output ripple voltage.

#### 3. Catch Diode Selection (D1)

- The catch diode current rating must be at least 1.3 times greater than the maximum load current. Also, if the power supply design must withstand a continuous output short, the diode should have a current rating equal to the maximum current limit of the GS5256. The most stressful condition for this diode is an overload or shorted output condition.
- The reverse voltage rating of the diode should be at least 1.25 times the maximum input voltage.
- This diode must be fast (short reverse recovery time) and must be located close to the GS5256 using short leads and short printed circuit traces. Because of their fast switching speed and low forward voltage drop, Schottky diodes provide the best performance and efficiency, and should be the first choice, especially in low output voltage applications. Ultra-fast recovery, or High-Efficiency rectifiers also provide good results. Ultra-fast recovery diodes typically have reverse recovery times of 50 ns or less. Rectifiers such as the 1N5400 series are much too slow and should not be used.

#### 4. Input Capacitor ( $C_{IN}$ )

A low ESR aluminum or tantalum bypass capacitor is needed between the input pin and ground pin to prevent large volt-age transients from appearing at the input. This capacitor should be located close to the IC using short leads. In addition, the RMS current rating of the input capacitor should be selected to be at least 1/2 the DC load current. The capacitor manufacturers data sheet must be checked to assure that this current rating is not exceeded. The curve shown in Figure 9 shows typical RMS current ratings for several different aluminum electrolytic capacitor values. For an aluminum electrolytic, the capacitor voltage rating should be approximately 1.5 times the maximum input voltage. The tantalum capacitor voltage rating should be 2 times the maximum input voltage and it is recommended that they be surge current tested by the manufacturer. Use caution when using ceramic capacitors for input bypassing, because it may cause severe ringing at the  $V_{IN}$  pin

### EXAMPLE (Fixed Output Voltage Version)

#### Given:

$V_{OUT}$  = 5V

$V_{IN}(\text{max})$  = 12V

$I_{LOAD}(\text{max})$  = 3A

#### 1. Inductor Selection (L1)

- Use the inductor selection guide for the 5V version shown.
- From the inductor value selection guide shown in Figure 5, the inductance region intersected by the 12V horizontal line and the 3A vertical line is 33  $\mu$ H, and the inductor code is L40.
- The inductance value required is 33  $\mu$ H. From the table in Figure 8, go to the L40 line and choose an inductor part number from any of the four manufacturers shown. (In most in-stance, both through hole and surface mount inductors are available.)



## 2. Output Capacitor Selection ( $C_{OUT}$ )

- A. See section on output capacitors in application information section.
- B. From the quick design component selection table shown in Figure 2, locate the 5V output voltage section. In the load current column, choose the load current line that is closest to the current needed in your application, for this example, use the 3A line. In the maximum input voltage column, select the line that covers the input voltage needed in your application, in this example, use the 15V line. Continuing on this line are recommended inductors and capacitors that will provide the best overall performance. The capacitor list contains both through hole electrolytic and surface mount tantalum capacitors from four different capacitor manufacturers. It is recommended that both the manufacturers and the manufacturer's series that are listed in the table be used. In this example aluminum electrolytic capacitors from several different manufacturers are available with the range of ESR numbers needed. 330 $\mu$ F 35V
- C. For a 5V output, a capacitor voltage rating at least 7.5V or more is needed. But even a low ESR, switching grade, 220 $\mu$ F 10V aluminum electrolytic capacitor would exhibit approximately 225 mW of ESR (see the curve in Figure 14 for the ESR vs voltage rating). This amount of ESR would result in relatively high output ripple voltage. To reduce the ripple to 1% of the output voltage, or less, a capacitor with a higher value or with a higher voltage rating (lower ESR) should be selected. A 16V or 25V capacitor will reduce the ripple voltage by approximately half.

## 3. Catch Diode Selection (D1)

- A. Refer to the table shown in Figure 11. In this example, a 5A, 20V, Schottky diode will provide the best performance, and will not be overstressed even for a shorted output.

## 4. Input Capacitor ( $C_{IN}$ )

The important parameters for the Input capacitor are the input voltage rating and the RMS current rating. With a nominal input voltage of 12V, an aluminum electrolytic capacitor with a voltage rating greater than 18V ( $1.5 \times V_{IN}$ ) would be needed. The next higher capacitor voltage rating is 25V. The RMS current rating requirement for the input capacitor in a buck regulator is approximately 1/2 the DC load current. In this example, with a 3A load, a capacitor with a RMS current rating of at least 1.5A is needed. The curves shown in Figure 9 can be used to select an appropriate input capacitor. From the curves, locate the 35V line and note which capacitor values have RMS current ratings greater than 1.5A. A 680 $\mu$ F/35V capacitor could be used.

For a through hole design, a 680 $\mu$ F/35V electrolytic capacitor (Panasonic HFQ series or Nichicon PL series or equivalent) would be adequate. Other types or other manufacturers capacitors can be used provided the RMS ripple current ratings are adequate.

For surface mount designs, solid tantalum capacitors can be used, but caution must be exercised with regard to the capacitor surge current rating.

### GS5256 Design Procedure (Fixed Output)

Conditions			Inductor
Output Voltage (V)	Load Current (A)	Max Input Voltage (V)	Inductance ( $\mu$ H)
3.3	3	5	22
		7	22
		10	22
	2	40	33
		6	22
		10	33
5.0	3	40	47
		8	22
		10	22
	2	15	33
		40	47
		9	22
		20	68
		40	68
		40	68

Figure 2. GS5256 Fixed Voltage Quick Design Component Selection Table

## GS5256 Design Procedure (Adjustable Output)

### PROCEDURE (Adjustable Output Voltage Version)

#### Given:

$V_{OUT}$  = Regulated Output Voltage

$V_{IN(max)}$  = Maximum Input Voltage

$I_{LOAD(max)}$  = Maximum Load Current

F = Switching Frequency (Fixed at a nominal 150kHz)

### 1. Programming Output Voltage

(Selecting  $R_1$  and  $R_2$ , as shown in Figure 1)

Use the following formula to select the appropriate resistor values.

$$V_{OUT} = V_{REF} \left( 1 + \frac{R_2}{R_1} \right) \quad \text{where } V_{REF} = 1.23V$$

Select a value for  $R_1$  between 240 $\Omega$  and 1.5k $\Omega$ . The lower resistor values minimize noise pickup in the sensitive feedback pin. (For the lowest temperature coefficient and the best stability with time, use 1% metal film resistors.)

$$R_2 = R_1 \left( \frac{V_{OUT}}{V_{REF}} - 1 \right)$$

### 2. Inductor Selection (L1)

A. Calculate the inductor Volt . microsecond constant  $E \cdot T$  ( $V \cdot \mu s$ ), from the following formula:

$$E \cdot T = (V_{IN} - V_{OUT} - V_{SAT}) \cdot \frac{V_{out} + V_D}{V_{IN} - V_{SAT} + V_D} \cdot \frac{1000}{150kHz} \quad (V \cdot \mu s)$$

where  $V_{SAT}$  = internal switch saturation voltage = 1.16V

and  $V_D$  = diode forward voltage drop = 0.5V

B. Use the  $E \cdot T$  value from the previous formula and match it with the  $E \cdot T$  number on the vertical axis of the Inductor Value Selection Guide shown in Figure 7.

C. on the horizontal axis, select the maximum load current.

D. Identify the inductance region intersected by the  $E \cdot T$  value and the Maximum Load Current value. Each region is identified by an inductance value and an inductor code (LXX).

E. Select an appropriate inductor from the four manufacturer's part numbers listed in Figure 8.

### 3. Output Capacitor Selection ( $C_{OUT}$ )

A. In the majority of applications, low ESR electrolytic or solid tantalum capacitors between 82 $\mu F$  and 820 $\mu F$  provide the best results. This capacitor should be located close to the IC using short capacitor leads and short copper traces. Do not use capacitors larger than 820 $\mu F$ .

B. To simplify the capacitor selection procedure, refer to the quick design table shown in Figure 3. This table contains different output voltages, and lists various output capacitors that will provide the best design solutions.

C. The capacitor voltage rating should be at least 1.5 times greater than the output voltage, and often much higher voltage ratings are needed to satisfy the low ESR requirements needed for low output ripple voltage.

### 4. Feedforward Capacitor ( $C_{FF}$ )

For output voltages greater than approximately 10V, an additional capacitor is required. The compensation capacitor is typically between 100 pF and 33 nF, and is wired in parallel with the output voltage setting resistor,  $R_2$ . It provides additional stability for high output voltages, low input-output voltages, and/or very low ESR output capacitors, such as solid tantalum capacitors.

$$C_{FF} = \frac{1}{31 \times 10^3 \times R_2}$$

This capacitor type can be ceramic, plastic, silver mica, etc.

### EXAMPLE (Adjustable Output Voltage Version)

#### Given:

$V_{OUT} = 20V$

$V_{IN(max)} = 28V$

$I_{LOAD(max)} = 3A$

F = Switching Frequency (Fixed at a nominal 150 kHz).

### 1. Programming Output Voltage

(Selecting  $R_1$  and  $R_2$ , as shown in Figure 1)

Select  $R_1$  to be  $1k_{\Omega}$ , 1%. Solve for  $R_2$ .

$$R_2 = R_1 \left( \frac{V_{OUT}}{V_{REF}} - 1 \right) = 1k \left( \frac{20V}{1.23V} - 1 \right)$$

$R_2 = 1k (16.26 - 1) = 15.26k$ , closest 1% value is a  $15.4k_{\Omega}$

$R_2 = 15.4k_{\Omega}$ .

### 2. Inductor Selection ( $L_1$ )

A. Calculate the inductor Volt•microsecond constant ( $E \cdot T$ ),

$$E \cdot T = (28 - 20 - 1.16) \cdot \frac{20 + 0.5}{28 - 1.16 + 0.5} \cdot \frac{1000}{150kHz} (V \cdot \mu s)$$

$$E \cdot T = (6.84) \cdot \frac{20.5}{27.34} \cdot 6.67 (V \cdot \mu s) = 34.2 (V \cdot \mu s)$$

B.  $E \cdot T = 34.2 (V \cdot \mu s)$

C.  $I_{LOAD} (max) = 3A$

D. From the inductor value selection guide shown in Figure 7, the inductance region intersected by the  $34 (V \cdot \mu s)$  horizontal line and the  $3A$  vertical line is  $47 \mu H$ , and the inductor code is L39.

E. From the table in Figure 8, locate line L39, and select an inductor part number from the list of manufacturers part numbers.

### 3. Output Capacitor Selection ( $C_{OUT}$ )

A. See section on  $C_{OUT}$  in Application Information section.

B. From the quick design table shown in Figure 3, locate the output voltage column. From that column, locate the output voltage closest to the output voltage in your application. In this example, select the  $24V$  line. Under the output capacitor section, select a capacitor from the list of through hole electrolytic or surface mount tantalum types from four different capacitor manufacturers. It is recommended that both the manufacturers and the manufacturers series that are listed in the table be used. In this example, through hole aluminum electrolytic capacitors from several different manufacturers are available.

$220 \mu F / 35V$  Panasonic HFQ Series

$150 \mu F / 35V$  Nichicon PL Series

C. For a  $20V$  output, a capacitor rating of at least  $30V$  or more is needed. In this example, either a  $35V$  or  $50V$  capacitor would work. A  $35V$  rating was chosen, although a  $50V$  rating could also be used if a lower output ripple voltage is needed.

Other manufacturers or other types of capacitors may also be used, provided the capacitor specifications (especially the  $100 kHz$  ESR) closely match the types listed in the table. Refer to the capacitor manufacturers data sheet for this information.

### 4. Feedforward Capacitor ( $C_{FF}$ )

The table shown in Figure 3 contains feed forward capacitor values for various output voltages. In this example, a  $560 pF$  capacitor is needed.

## Package Dimension

### TO-220-5 Plastic Package

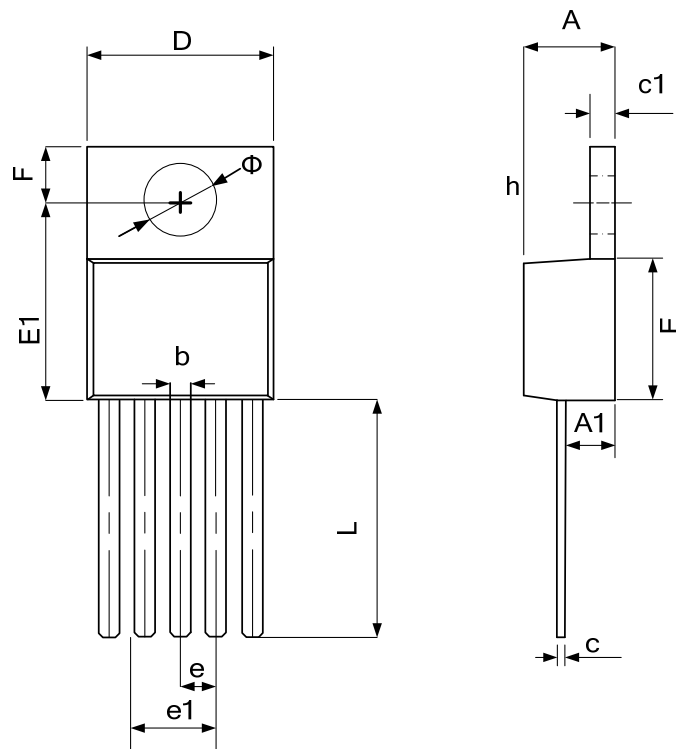

Dimensions				
SYMBOL	Millimeters		Inches	
	MIN	MAX	MIN	MAX
<b>A</b>	4.47	4.67	.176	.184
<b>A1</b>	2.52	2.82	.099	.111
<b>b</b>	0.71	0.91	.028	.036
<b>c</b>	0.31	0.53	.012	.021
<b>c1</b>	1.17	1.37	.046	.054
<b>D</b>	9.85	10.15	.388	.400
<b>E</b>	8.20	8.60	.323	.339
<b>E1</b>	11.76	12.16	.463	.479
<b>e</b>	1.70 (TYP)		0.067(TYP)	
<b>e1</b>	6.70	6.90	.264	.272
<b>F</b>	2.59	2.89	.102	.114
<b>L</b>	13.50	13.90	.531	.547
<b><math>\Phi</math></b>	3.79	3.89	.149	.153

# TO-263-5L Plastic Package

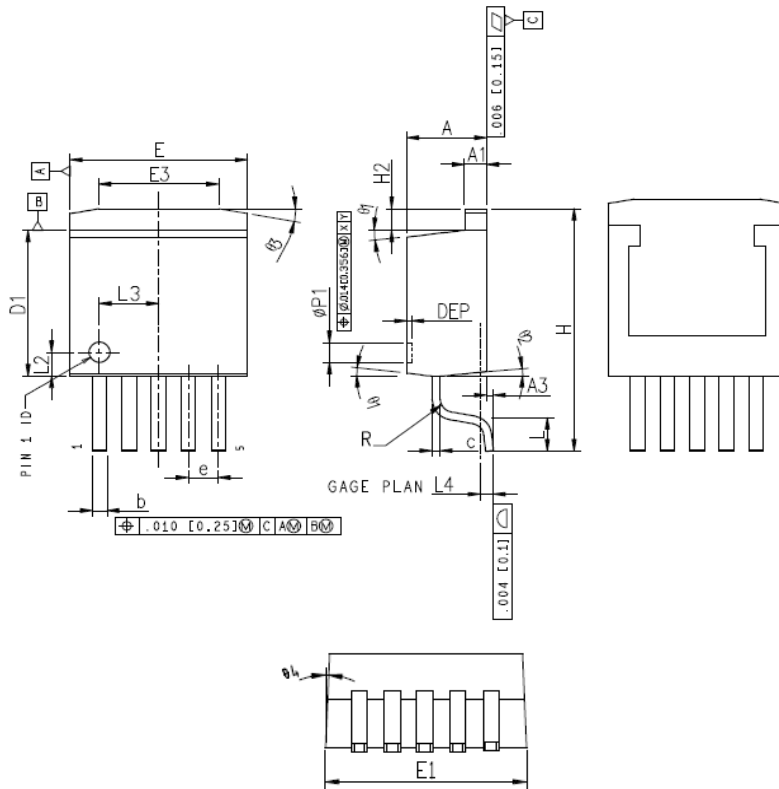

## Dimensions

SYMBOL	Millimeters			Inches		
	MIN	NOM	MAX	MIN	NOM	MAX
<b>A</b>	4.45	4.57	4.70	0.175	0.180	0.185
<b>A1</b>	1.22	1.27	1.32	0.048	0.050	0.052
<b>A3</b>	0	-	0.15	0.000	-	0.006
<b>b</b>	0.71	-	0.97	0.028	-	0.038
<b>C</b>	0.38	-	0.76	0.015	-	0.030
<b>D1</b>	8.38	8.70	8.89	0.330	0.343	0.350
<b>E</b>	9.91	10.16	10.39	0.390	0.400	0.410
<b>E1</b>	10.03	10.16	10.54	0.395	0.400	0.415
<b>E3</b>	6.61	6.86	7.11	0.260	0.270	0.280
<b>e</b>	1.70 (BSC)			0.067 (BSC)		
<b>H</b>	-	-	15.88	-	-	0.625
<b>H2</b>	-	-	1.27	-	-	0.050
<b>L</b>	-	1.98	-	-	0.078	-
<b>L2</b>	1.47 (REF)			0.058 (REF)		
<b>L3</b>	3.40 (REF)			0.134 (REF)		





## Dimensions

SYMBOL	Millimeters			Inches		
	MIN	NOM	MAX	MIN	NOM	MAX
<b>L4</b>	-	0.76	-	-	0.030	-
<b>Φ<sub>p1</sub></b>	1.07	1.20	1.32	0.042	0.047	0.052
<b>R</b>	-	-	0.76	-	-	0.030
<b>θ1</b>	-	7°	-	-	7°	-
<b>θ2</b>	-	3°	-	-	3°	-
<b>θ3</b>	7°	10°	13°	7°	10°	13°
<b>θ4</b>	-	3°	-	-	3°	-
<b>DEP</b>	0.10	0.18	0.25	0.004	0.007	0.010



## NOTICE

Information furnished is believed to be accurate and reliable. However Globaltech Semiconductor assumes no responsibility for the consequences of use of such information nor for any infringement of patents or other rights of third parties, which may result from its use. No license is granted by implication or otherwise under any patent or patent rights of Globaltech Semiconductor. Specifications mentioned in this publication are subject to change without notice. This publication supersedes and replaces all information without express written approval of Globaltech Semiconductor.

## CONTACT US

GS Headquarter	
	4F.,No.43-1,Lane11,Sec.6,Minquan E.Rd Neihu District Taipei City 114, Taiwan (R.O.C)
	886-2-2657-9980
	886-2-2657-3630
	sales_twn@gs-power.com

Wu-Xi Branch	
	No.21 Changjiang Rd., WND, Wuxi, Jiangsu, China (INFO. & TECH. Science Park Building A 210 Room)
	86-510-85217051
	86-510-85211238
	sales_cn@gs-power.com

RD Division	
	824 Bolton Drive Milpitas. CA. 95035
	1-408-457-0587