

## Features

- Low Supply Current ~ 36uA (Typ.)
- Low Shutdown Current ~0.1uA (Typ.)
- Output Current ~150mA
- High Power Supply Rejection Ratio ~78db@1KHz
- 1.7~6.5V Operation
- ±1.0% Initial Voltage Accuracy
- Low Temperature Drift Coefficient ~50ppm
- Line Regulation ~0.02%/V(Typ.)
- Low ESR Capacitor ~0.47uF ceramic capacitor
- uDFN4-1x1、SOT-23-5、SC-82、MSOT-23 package
- Green Product (RoHS, Lead-Free, Halogen-Free Compliant)

## Applications

- Portable communication equipment
- Notebook Computer
- Battery Powered Systems

## Typical Application

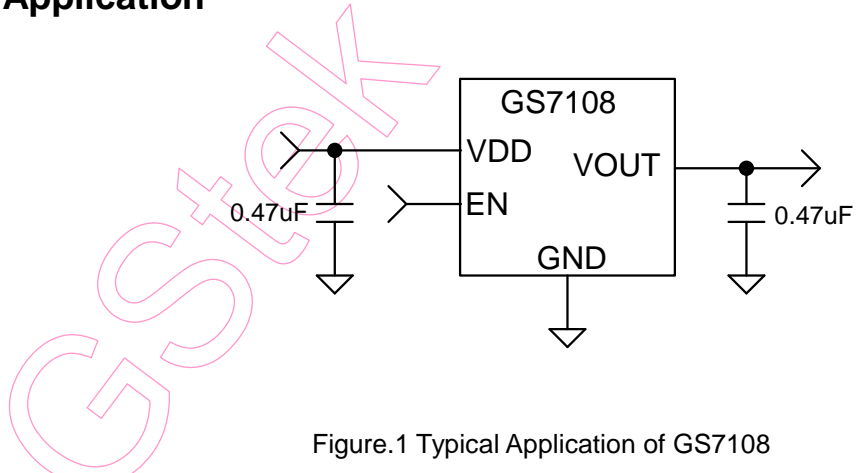

Figure.1 Typical Application of GS7108

## General Description

The GS7108 is a CMOS linear regulator. It is featuring ultra-high power supply rejection ratio, low output voltage noise, low dropout voltage, low quiescent current and fast transient response. It guarantees delivery of 150mA output current, and supports preset 1.2V, 1.3V, 1.5V, 1.8V, 1.85V, 1.9V, 2.0V, 2.3V, 2.5V, 2.6V, 2.7V, 2.8V, 2.85V, 2.9V, 3.0V, 3.1V, 3.3V, 3.8V, 4.0V, 4.2V, 4.5V, 4.75V, 4.8V, 5.0V output voltage versions.

Based on its low quiescent current consumption and its less than 1uA shutdown mode, the GS7108 is ideal for battery- powered applications. The high power supply rejection ratio of the GS7108 holds well for low input voltages typically encountered in battery- operated systems. The regulator is stable with small ceramic capacitive loads (0.47μF typical).

**Function Block Diagram**

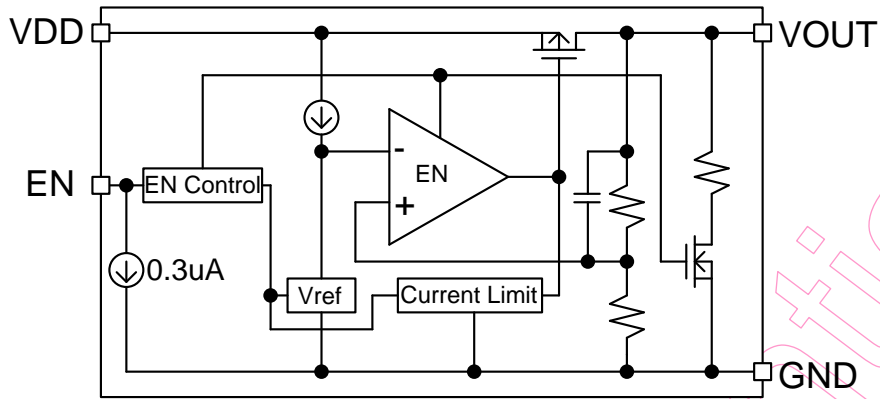

Figure 2a with auto discharge function (default)

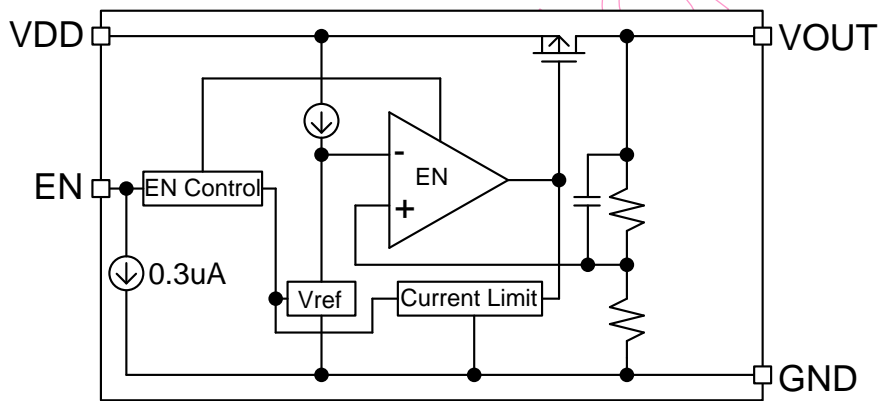

Figure 2b without auto discharge function (special order)

Figure 2 Function Block Diagram

## Pin Configuration

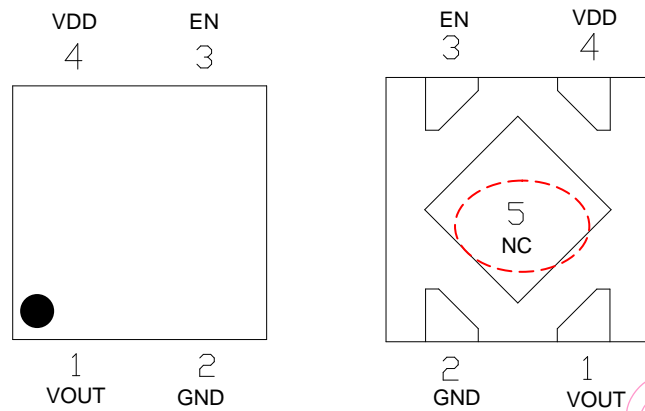

Figure 3a uDFN4-1x1 Package

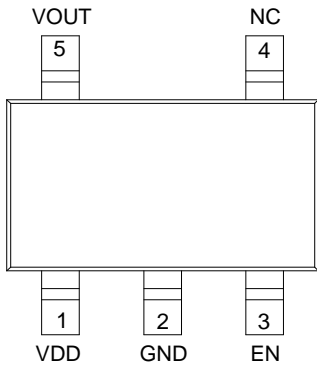

Figure 3b SOT-23-5 Package

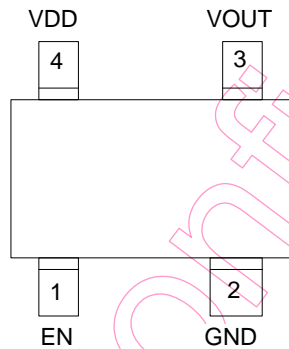

Figure 3c SC-82 Package

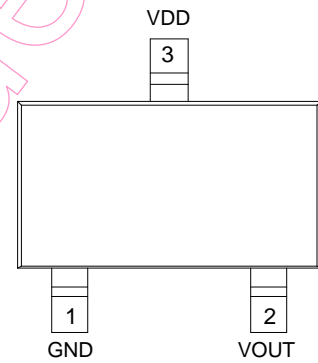

Figure 3d MSOT-23 Package

## Pin Descriptions

| No        |          |       |         | Name | I/O type | Description |
|-----------|----------|-------|---------|------|----------|-------------|
| uDFN4-1x1 | SOT-23-5 | SC-82 | MSOT-23 |      |          |             |
| 1         | 5        | 3     | 2       | VOUT | O        | Output pin  |
| 2         | 2        | 2     | 1       | GND  | O        | Ground pin  |
| 3         | 3        | 1     |         | EN   | I        | Enable Pin  |
| 4         | 1        | 4     | 3       | VDD  | I        | Input Pin   |
| 5         | 4        |       |         | NC   |          |             |

## Ordering Information

**GS7108PP-XXX- R**



| No | Item           | Contents  |
|----|----------------|---|
| 1  | Package        | UD: uDFN4-1x1<br>ST: SOT-23-5<br>SC: SC-82<br>SR: MSOT-23   |
| 2  | Output Voltage | 1P2: 1.2V, 1P3: 1.3V, 1P5: 1.5V, 1P8: 1.8V, 185: 1.85V, 1P9: 1.9V, 2P0: 2.0V, 2P3: 2.3V, 2P5: 2.5V, 2P6: 2.6V, 2P7: 2.7V, 2P8: 2.8V, 285: 2.85V, 2P9: 2.9V, 3P0: 3.0V, 3P1: 3.1V, 3P3: 3.3V, 3P8: 3.8V, 4P0: 4.0V, 4P2: 4.2V, 4P5: 4.5V, 475: 4.75V, 4P8: 4.8V, 5P0: 5.0V |
| 3  | Shipping       | R: Tape & Reel  |

Example: GS7108 SC-82 2.5V Tape & Reel ordering information is “GS7108SC-2P5-R”

## Absolute Maximum Rating (Note 1)

| Parameter  | Symbol             | Limits                          | Units            |
|--|--------------------|---------------------------------|------------------|
| VIN to GND   | $V_{IN}$           | $-0.3 < V_{IN} < 7$             | V                |
| VEN to GND   | $V_{EN}$           | $-0.3 < V_{EN} < 7$             | V                |
| Output Voltage   | $V_{OUT}$          | $-0.3 < V_{OUT} < V_{IN} + 0.3$ | V                |
| Output Current   | $I_{OUT}$          | 200                             | mA               |
| Package Power Dissipation at $T_A \leq 25^\circ\text{C}$ | $P_{D\_uDFN4-1x1}$ | 400                             | mW               |
| Package Power Dissipation at $T_A \leq 25^\circ\text{C}$ | $P_{D\_SOT-23-5}$  | 420                             | mW               |
| Package Power Dissipation at $T_A \leq 25^\circ\text{C}$ | $P_{D\_SC82}$      | 380                             | mW               |
| Package Power Dissipation at $T_A \leq 25^\circ\text{C}$ | $P_{D\_MSOT-23}$   | 380                             | mW               |
| Junction Temperature                                     | $T_J$              | - 45 ~ 150                      | $^\circ\text{C}$ |
| Storage Temperature                                      | $T_{STG}$          | - 65 ~ 150                      | $^\circ\text{C}$ |
| Lead Temperature (Soldering) 10S                         | $T_{LEAD}$         | 260                             | $^\circ\text{C}$ |
| ESD (Human Body Mode) (Note 2)                           | $V_{ESD\_HBM}$     | 4K                              | V                |
| ESD (Machine Mode) (Note 2)                              | $V_{ESD\_MM}$      | 400                             | V                |

### Thermal Information (Note 3)

| Parameter                              | Symbol                   | Limits | Units |
|--|--------------------------|--------|-------|
| Thermal Resistance Junction to Ambient | $\theta_{JA\_uDFN4-1x1}$ | 250    | °C/W  |
| Thermal Resistance Junction to Case    | $\theta_{JC\_uDFN4-1x1}$ | 67     | °C/W  |
| Thermal Resistance Junction to Ambient | $\theta_{JA\_SOT-23-5}$  | 238    | °C/W  |
| Thermal Resistance Junction to Case    | $\theta_{JC\_SOT-23-5}$  | 110    | °C/W  |
| Thermal Resistance Junction to Ambient | $\theta_{JA\_SC-82}$     | 263    | °C/W  |
| Thermal Resistance Junction to Ambient | $\theta_{JA\_MSOT-23}$   | 263    | °C/W  |
| Thermal Resistance Junction to Case    | $\theta_{JC\_MSOT-23}$   | 140    | °C/W  |

### Recommend Operating Condition (Note 4)

| Parameter                   | Symbol   | Limits     | Units |
|-----------------------------|----------|------------|-------|
| VIN to GND                  | $V_{IN}$ | 1.7 to 6.5 | V     |
| Junction Temperature Range  | $T_J$    | -40 ~ 125  | °C    |
| Operating Temperature Range | $T_A$    | -40 ~ 85   | °C    |

### Electrical Characteristics

( $V_{IN} = V_{OUT} + 1V$ ,  $T_A = -40^{\circ}C$  to  $+85^{\circ}C$ ,  $C_{IN}=C_L=0.47\mu F$ ,  $I_{OUT}=1mA$ , unless otherwise specified)

| Parameter                     | Symbol     | Conditions                             | Min                | Typ    | Max | Units  |    |
|-------------------------------|------------|--|--------------------|--------|-----|--------|----|
| <b>SUPPLY VOLTAGE SECTION</b> |            |  |                    |        |     |        |    |
| Supply Voltage                | $V_{IN}$   |  | 1.7                |        | 6.5 | V      |    |
| Supply Current                | $I_{VIN}$  | Unload                                 |                    | 36     | 60  | uA     |    |
| Standby Current               | $I_{STBY}$ | $V_{EN}=0$                             |                    | 0.1    | 1.0 | uA     |    |
| EN Input Current              | $I_{EN}$   | $V_{EN}=V_{IN}=7V$                     |                    | 0.3    |     | uA     |    |
| Output Current                | $I_{OUT}$  |  | 150                |        |     | mA     |    |
| <b>OUTPUT SECTION</b>         |            |  |                    |        |     |        |    |
| Output Voltage                | $V_{OUT}$  | $T_A = 25^{\circ}C$                    | $V_{OUT}>2.0V$     | x0.99  |     | x1.01  | V  |
|                               |            |  | $V_{OUT}\leq 2.0V$ | -20    |     | 20     | mV |
|                               |            | $T_A = -40^{\circ}C$ to $+85^{\circ}C$ | $V_{OUT}>2.0V$     | x0.985 |     | x1.015 | V  |
|                               |            |  | $V_{OUT}\leq 2.0V$ | -30    |     | 30     | mV |

|                                       |                               |  |                               |      |      |                 |   |
|---------------------------------------|-------------------------------|--|-------------------------------|------|------|-----------------|---|
| Dropout Voltage (Note 5)              | $V_{DROPO}$                   | $I_{OUT}=150mA$  | $1.2V \leq V_{OUT} < 1.5V$    |      | 0.50 | 0.62            | V |
|                                       |                               |  | $1.5V \leq V_{OUT} < 1.7V$    |      | 0.38 | 0.47            |   |
|                                       |                               |  | $1.7V \leq V_{OUT} < 2.0V$    |      | 0.34 | 0.42            |   |
|                                       |                               |  | $2.0V \leq V_{OUT} < 2.5V$    |      | 0.28 | 0.36            |   |
|                                       |                               |  | $2.5V \leq V_{OUT} < 2.8V$    |      | 0.22 | 0.30            |   |
|                                       |                               |  | $2.8V \leq V_{OUT} \leq 3.3V$ |      | 0.21 | 0.27            |   |
|                                       |                               |  | $3.3V \leq V_{OUT} \leq 4.0V$ |      | 0.20 | 0.26            |   |
|                                       |                               |  | $4.0V \leq V_{OUT} \leq 5.0V$ |      | 0.19 | 0.25            |   |
| Line Regulation                       | $\Delta V_{LNR}$              | $V_{IN} = V_{OUT} + 0.5V$ to 6.5V,<br>$I_{OUT}=1mA$  |                               | 0.02 | 0.10 | %/V             |   |
| Load Regulation                       | $\Delta V_{LDR}$              | $V_{IN} = V_{OUT} + 1V$ ,<br>$I_{OUT}=1mA$ to 150mA  |                               | 15   | 30   | mV              |   |
| Ripple Rejection Rate                 | PSRR                          | $V_{IN} = \text{MAX}\{V_{OUT} + 1.0V, 3V\}$ , Ripple<br>0.2Vp-p, $I_{OUT}=30mA$ , $f=1KHz$ |                               | 78   |      | dB              |   |
| Limit Current                         | $I_{lim}$                     | $V_{EN}=V_{IN}$  |                               | 260  |      | mA              |   |
| Short Current                         | $I_{short}$                   | $V_{OUT}=0V$   |                               | 35   |      | mA              |   |
| EN Input Voltage High                 | $V_{ENH}$                     |  | 1.5                           |      |      | V               |   |
| EN Input Voltage Low                  | $V_{ENL}$                     |  |                               |      | 0.3  | V               |   |
| CL Auto-Discharge Resistance (Note 6) | $R_{dischg}$                  | $V_{IN}=4.0V$ , $V_{EN}=0V$  |                               | 100  |      | $\Omega$        |   |
| Temperature Drift                     | $\Delta V_{OUT} / \Delta T_A$ | $I_{OUT}=1mA$ ,<br>$T_A = -40^\circ C$ to $+85^\circ C$                                    |                               | 50   |      | ppm/ $^\circ C$ |   |

**Note 1.** Stresses listed as the above “Absolute Maximum Ratings” may cause permanent damage to the device. These are for stress ratings. Functional operation of the device at these or any other conditions beyond those indicated in the operational sections of the specifications is not implied. Exposure to absolute maximum rating conditions for extended periods may remain possibility to affect device reliability.

**Note 2.** Devices are ESD sensitive. Handling precaution recommended.

**Note 3.**  $\theta_{JA}$  is measured in the natural convection at  $T_A=25^\circ C$  on a high effective thermal conductivity test board (4 Layers, 2S2P) of JEDEC 51-7 thermal measurement standard.

**Note 4.** The device is not guaranteed to function outside its operating conditions.

**Note 5.** The dropout voltage is defined as  $V_{IN} - V_{OUT}$ , which is measured when  $V_{OUT}$  is 98%\* $V_{OUT}$ .

**Note 6.** The output voltage Auto discharge function is optional.

**Typical Characteristics**

**Output Voltage vs. Output Current**

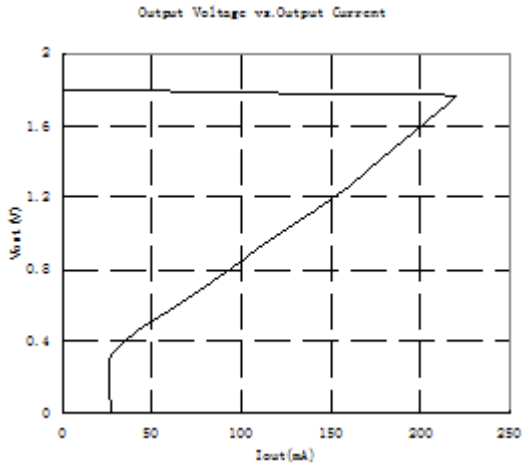

$V_{OUT}=1.8V, V_{DD}=2.8V$

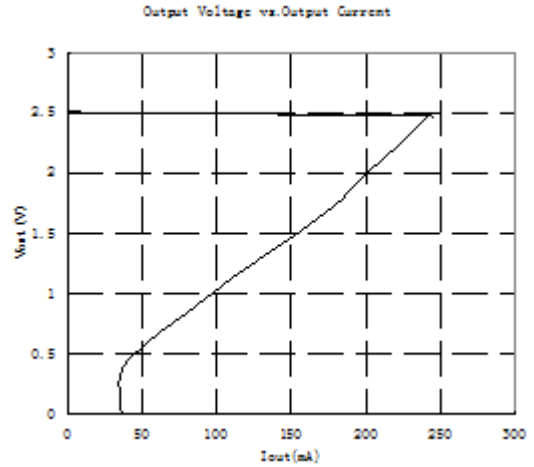

$V_{OUT}=2.5V, V_{DD}=3.5V$

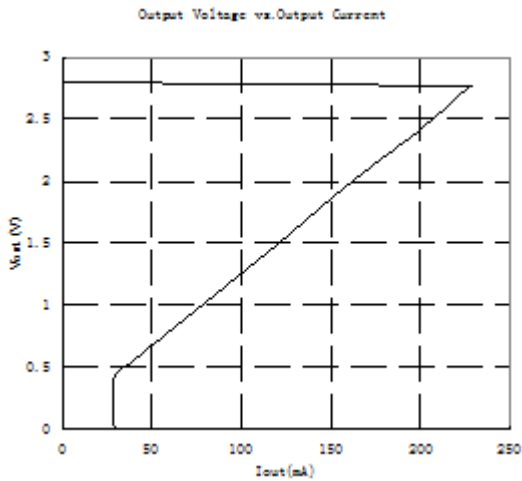

$V_{OUT}=2.8V, V_{DD}=3.8V$

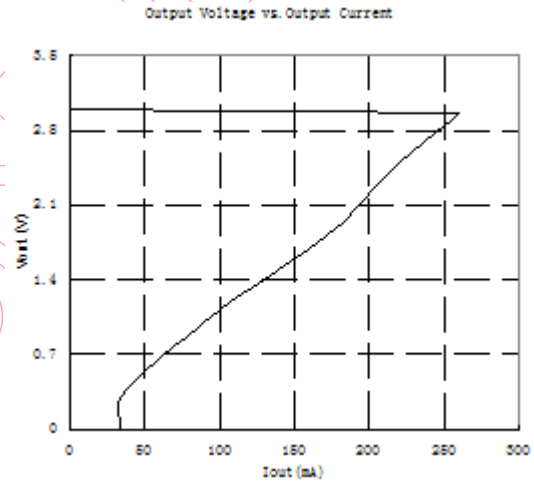

$V_{OUT}=3.3V, V_{DD}=4V$

**Output Voltage vs. Input Voltage**

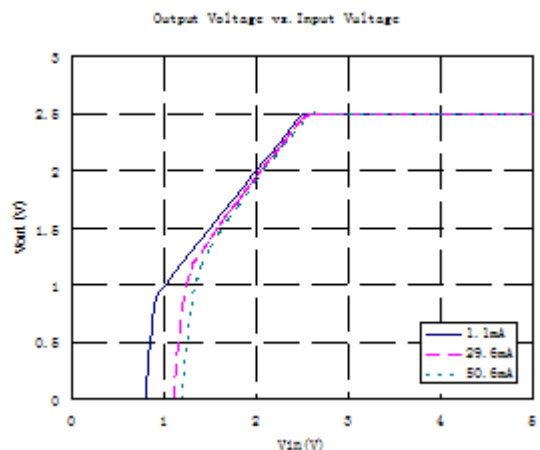
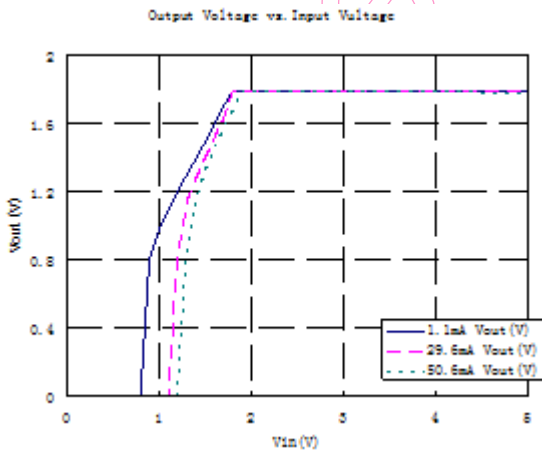

$V_{OUT}=1.8V, I_{OUT}=1mA, 30mA, 50mA$

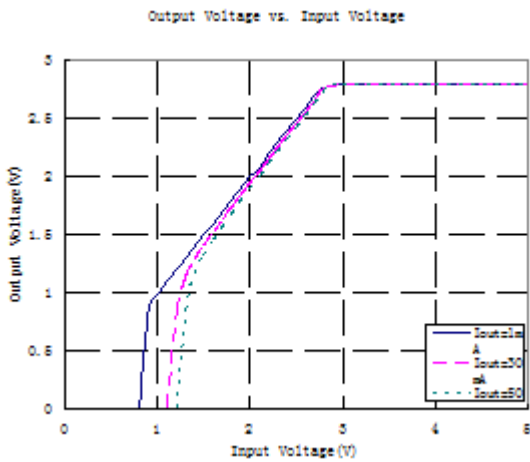

$V_{OUT}=2.5V, I_{OUT}=1mA, 30mA, 50mA$

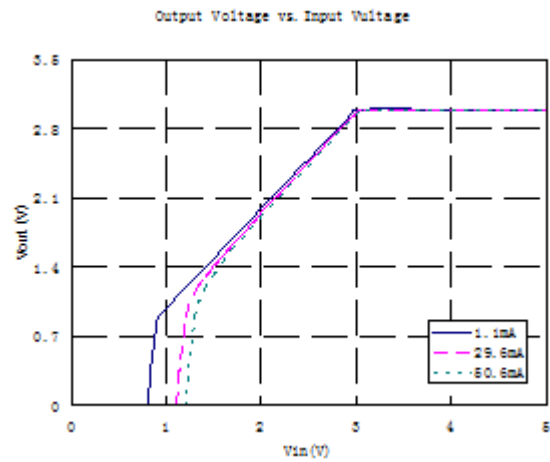

$V_{OUT}=2.8V, I_{OUT}=1mA, 30mA, 50mA$

$V_{OUT}=3.0V, I_{OUT}=1mA, 30mA, 50mA$

### Supply Current vs. Input Voltage

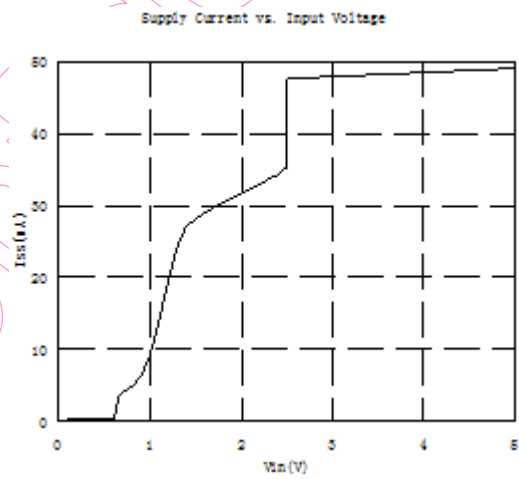
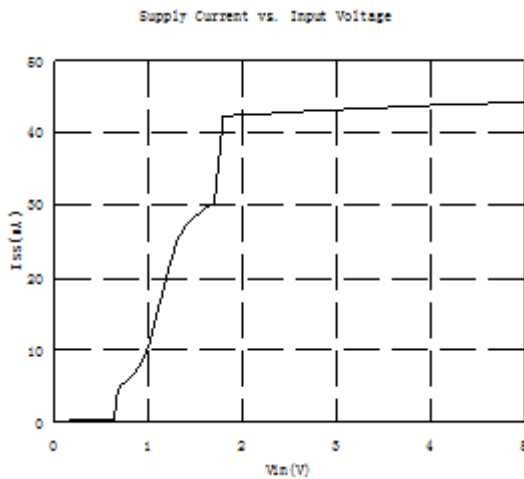

$V_{OUT}=1.2V, I_{OUT}=unload$

$V_{OUT}=2.5V, I_{OUT}=unload$

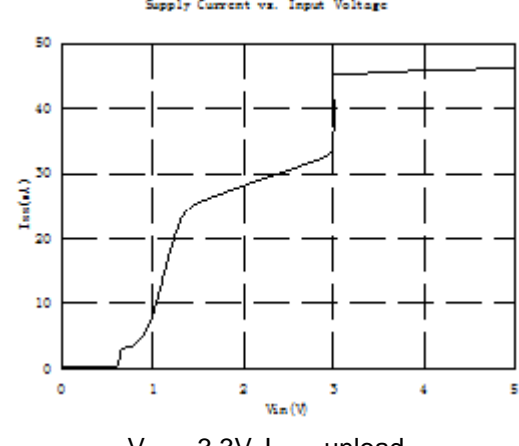
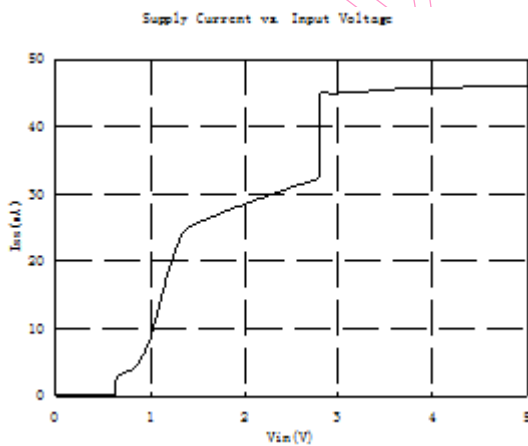

$V_{OUT}=2.8V, I_{OUT}=unload$

$V_{OUT}=3.3V, I_{OUT}=unload$



### Output Voltage vs. Temperature

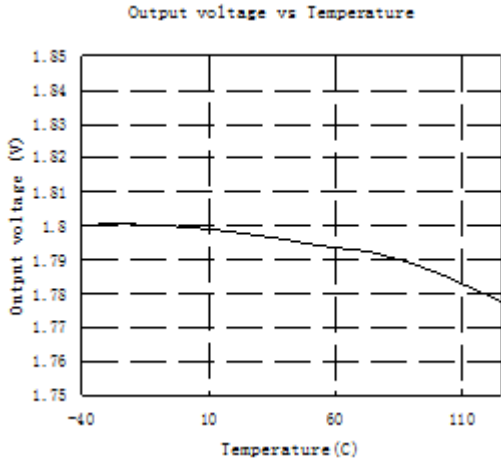

V<sub>OUT</sub>=1.8V, I<sub>OUT</sub>=1mA, V<sub>DD</sub>=2.8V

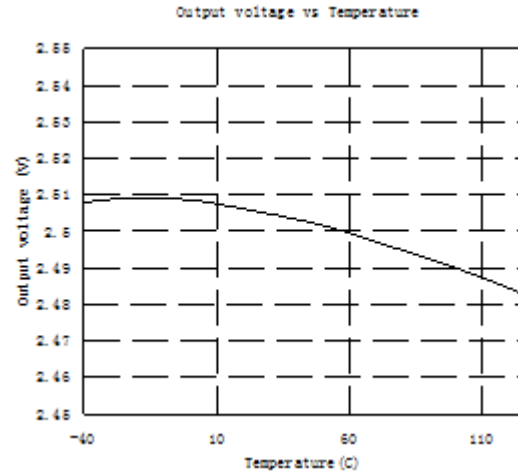

V<sub>OUT</sub>=2.5V, I<sub>OUT</sub>=1mA, V<sub>DD</sub>=3.5V

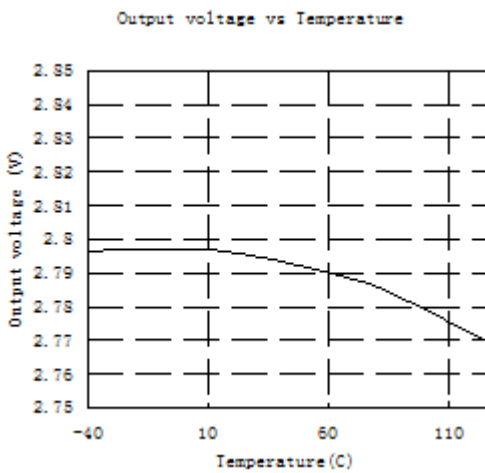

V<sub>OUT</sub>=2.8V, I<sub>OUT</sub>=1mA, V<sub>DD</sub>=3.8V

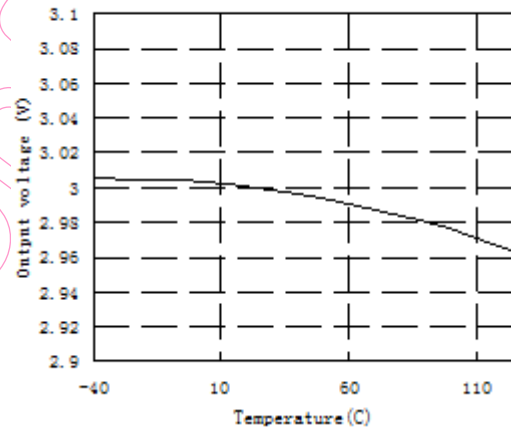

V<sub>OUT</sub>=3.0V, I<sub>OUT</sub>=1mA, V<sub>DD</sub>=4.0V

### Supply Current vs. Temperature

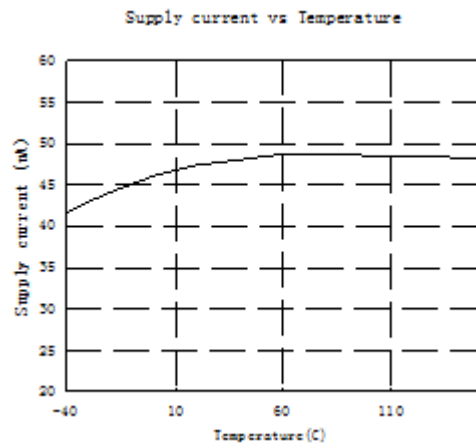
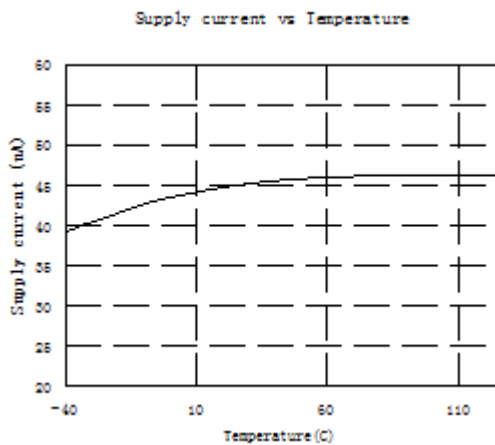

$V_{OUT}=1.8V, I_{OUT}=1mA, V_{DD}=2.8V$

Supply current vs Temperature

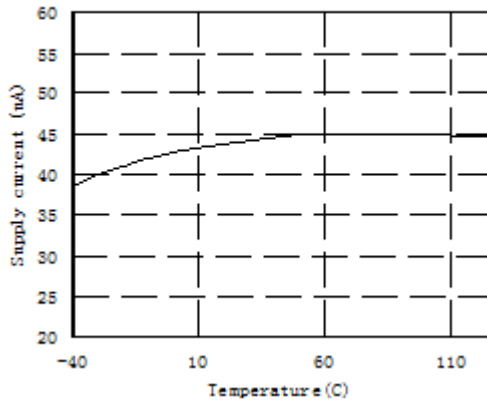

$V_{OUT}=2.5V, I_{OUT}=1mA, V_{DD}=3.5V$

Supply current vs Temperature

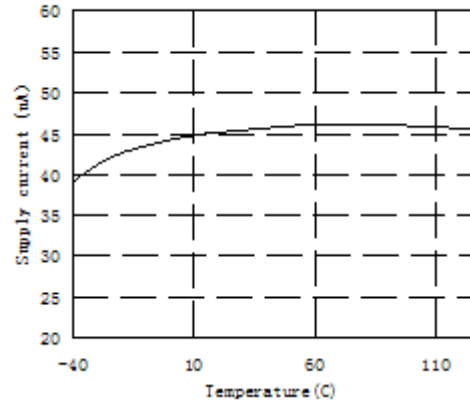

$V_{OUT}=2.8V, I_{OUT}=1mA, V_{DD}=3.8V$

$V_{OUT}=3.0V, I_{OUT}=1mA, V_{DD}=4.0V$

### Dropout Voltage vs. Output Current

1.8v Dropout Voltage vs Temperature

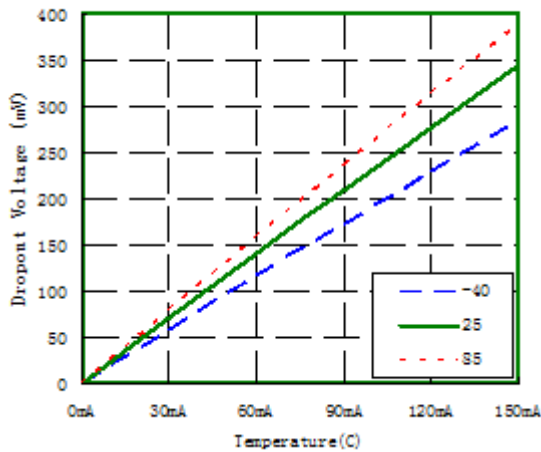

2.5v Dropout Voltage vs Temperature

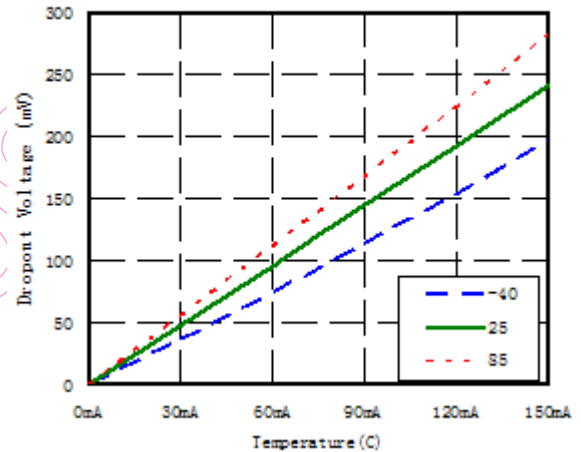

$V_{OUT}=1.8V, Temp=-40^{\circ}C, 25^{\circ}C, 85^{\circ}C$

$V_{OUT}=2.5V, Temp=-40^{\circ}C, 25^{\circ}C, 85^{\circ}C$

2.8v Dropout Voltage vs Temperature

3.0v Dropout Voltage vs Temperature

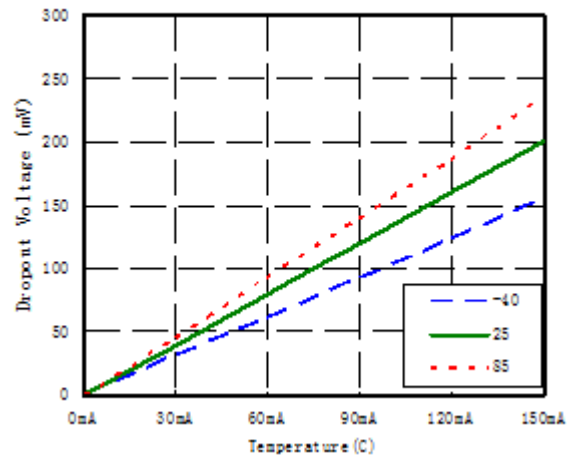
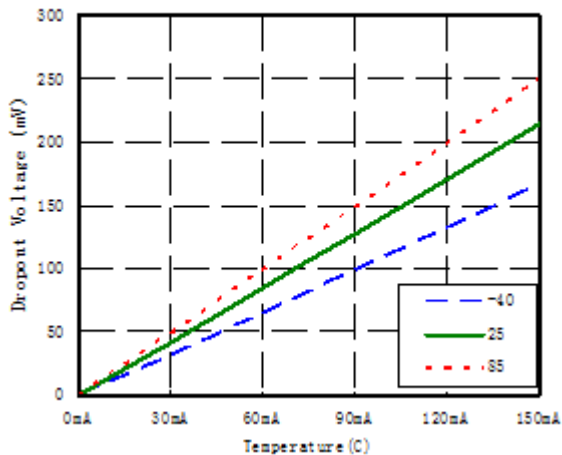

$V_{OUT}=2.8V, Temp=-40^{\circ}C, 25^{\circ}C, 85^{\circ}C$

$V_{OUT}=3.0V, Temp=-40^{\circ}C, 25^{\circ}C, 85^{\circ}C$

**Dropout Voltage vs. Set Output Voltage**

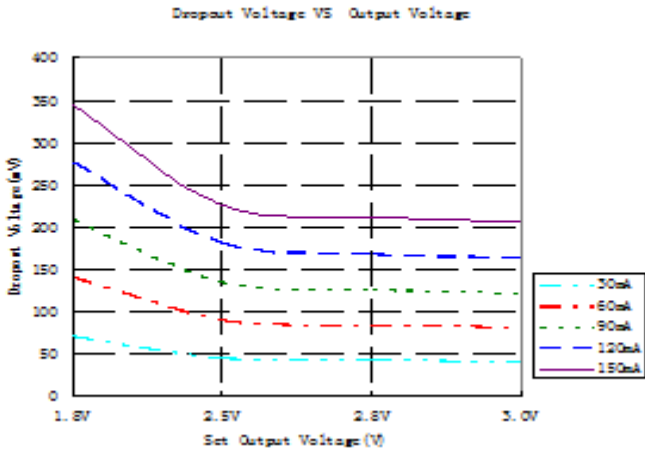

$I_{OUT}=30mA, 60mA, 90mA, 120mA, 150mA, Temp = 25^{\circ}C$

**Ripple Rejection vs. Input Bias Voltage**

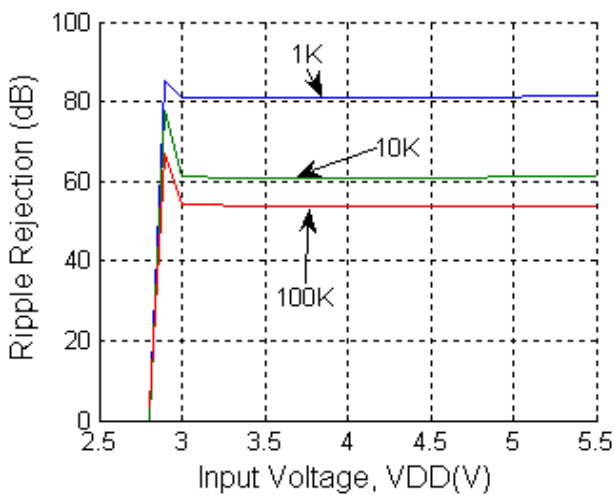

$I_{OUT}=1mA, V_{OUT}=2.8V, Freq=1kHz, 10kHz, 100kHz$

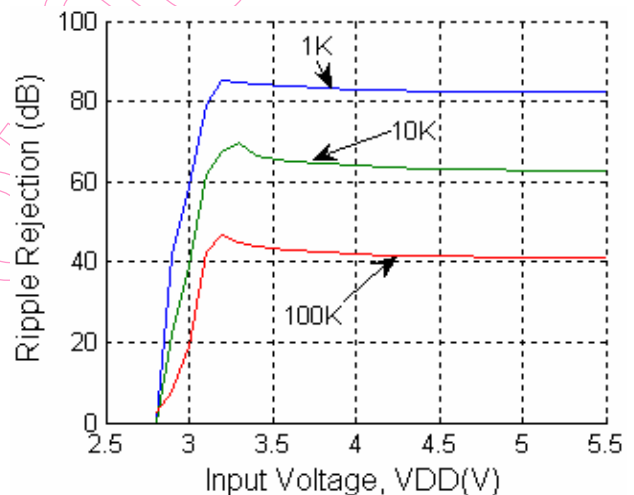

$I_{OUT}=30mA, V_{OUT}=2.8V, Freq=1kHz, 10kHz, 100kHz$

**Ripple Rejection vs. Frequency**

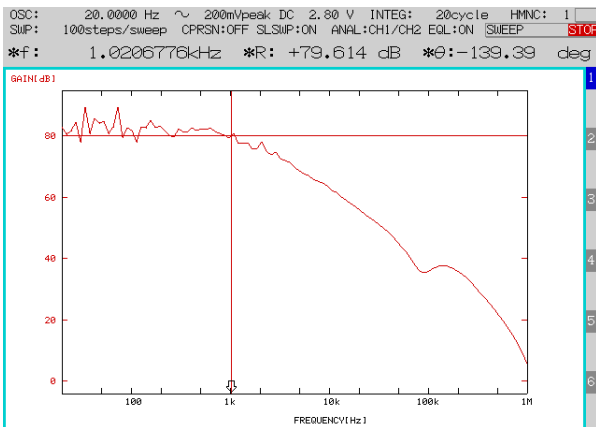

$V_{OUT}=1.8V, V_{DD}=2.8V, I_{OUT}=1mA$

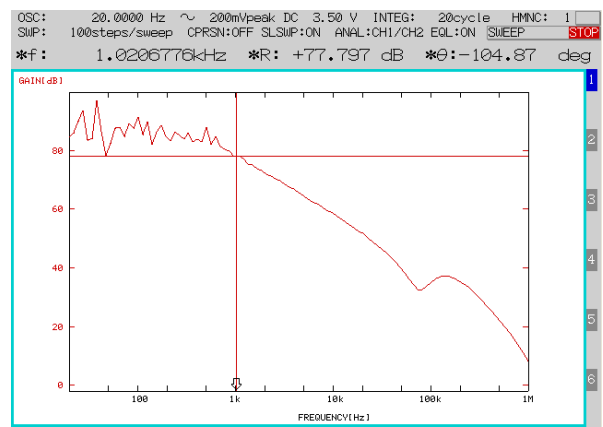

$V_{OUT}=2.5V, V_{DD}=3.5V, I_{OUT}=1mA$

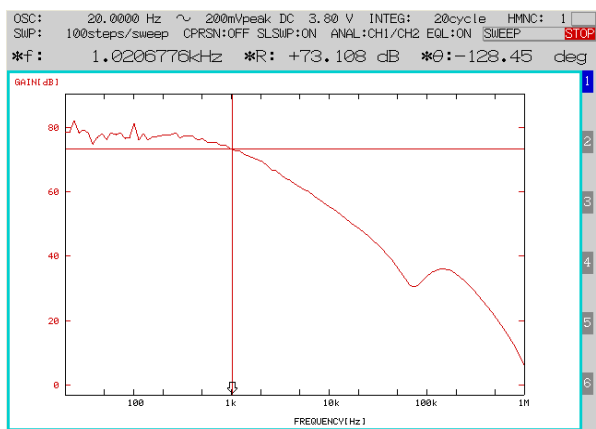

$V_{OUT}=2.8V, V_{DD}=3.8V, I_{OUT}=1mA$

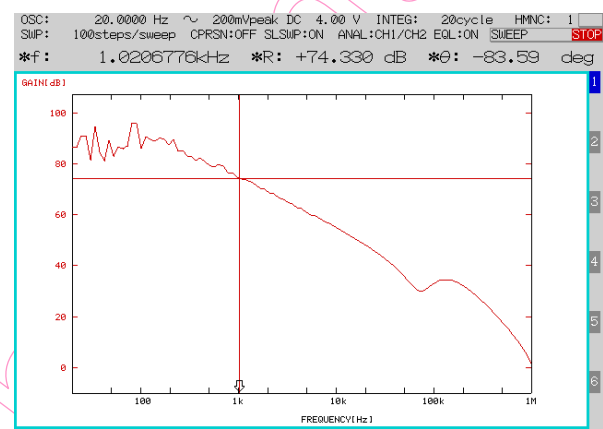

$V_{OUT}=3.0V, V_{DD}=4.0V, I_{OUT}=1mA$

### Input Transient Response

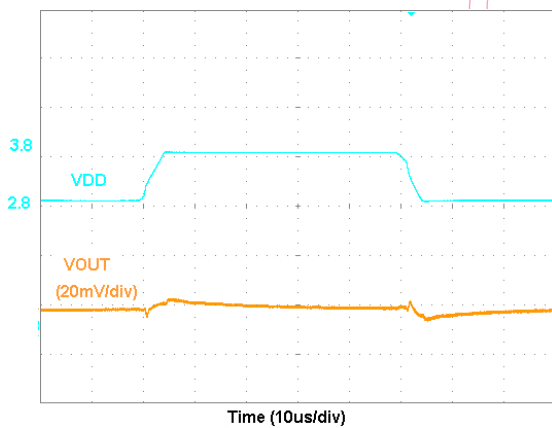

$V_{OUT}=1.8V, V_{DD}=2.8V \sim 3.8V \sim 2.8V, I_{OUT}=30mA$   
 $tr=tf=5\mu s$

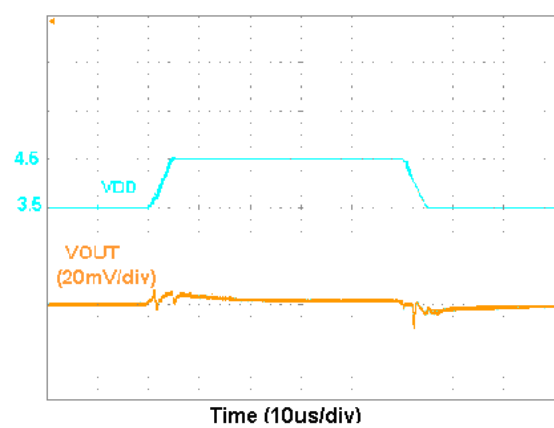

$V_{OUT}=2.5V, V_{DD}=3.5V \sim 4.5V \sim 3.5V, I_{OUT}=30mA$   
 $tr=tf=5\mu s$

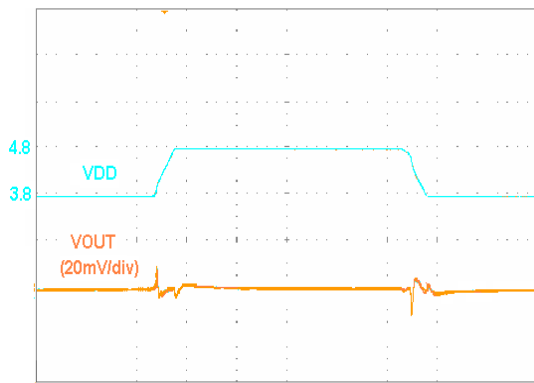

Time (10us/div)

$V_{OUT}=2.8V$ ,  $V_{DD}=3.8V\sim 4.8V\sim 3.8V$ ,  $I_{OUT}=30mA$   
 $tr=tf=5\mu s$

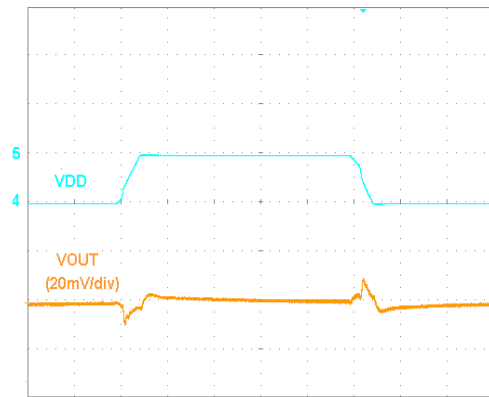

Time (10us/div)

$V_{OUT}=3.0V$ ,  $V_{DD}=4.0V\sim 5.0V\sim 4.0V$ ,  $I_{OUT}=30mA$   
 $tr=tf=5\mu s$

### Load Transient Response

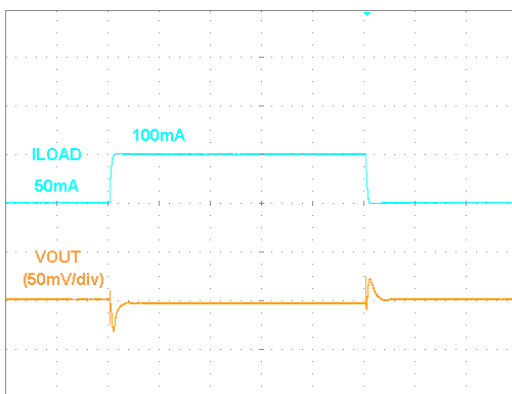

Time (10us/div)

$V_{OUT}=1.8V$ ,  $I_{OUT}=50mA\sim 100mA\sim 50mA$ ,  $V_{DD}=2.8V$   
 $tr=tf=0.5\mu s$

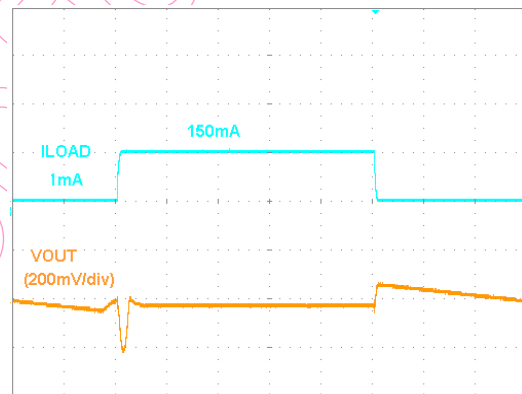

Time (10us/div)

$V_{OUT}=1.8V$ ,  $I_{OUT}=1mA\sim 150mA\sim 1mA$ ,  $V_{DD}=2.8V$   
 $tr=tf=0.5\mu s$

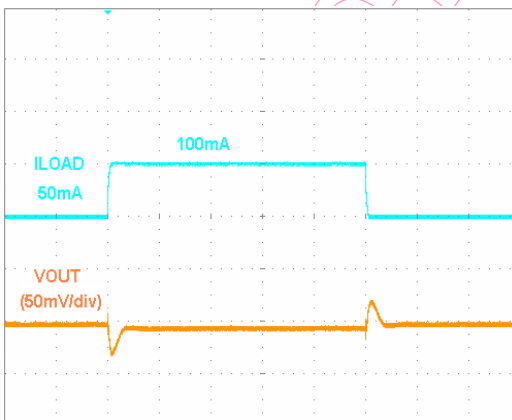

Time (10us/div)

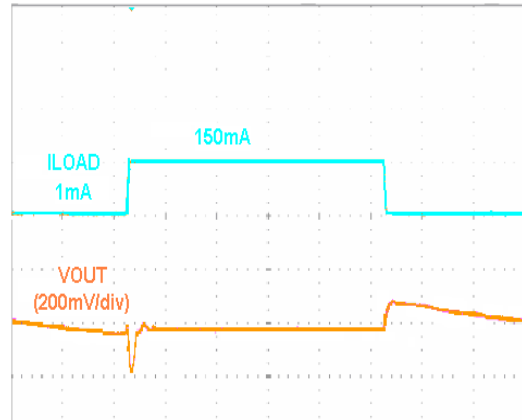

Time (10us/div)

$V_{OUT}=2.5V$ ,  $I_{OUT}=50mA \sim 100mA \sim 50mA$ ,  $V_{DD}=3.5V$   
 $tr=tf=0.5\mu s$

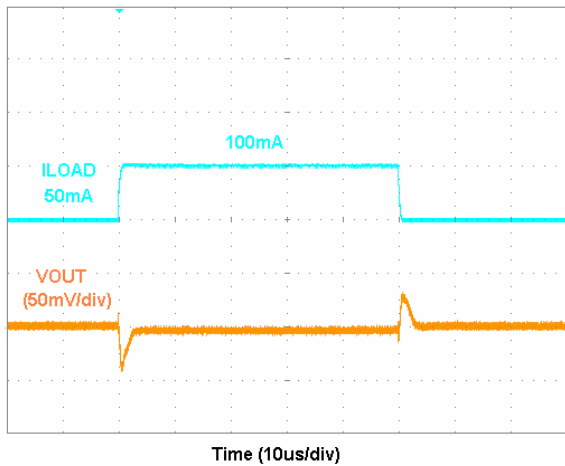

$V_{OUT}=2.5V$ ,  $I_{OUT}=1mA \sim 150mA \sim 1mA$ ,  $V_{DD}=3.5V$   
 $tr=tf=0.5\mu s$

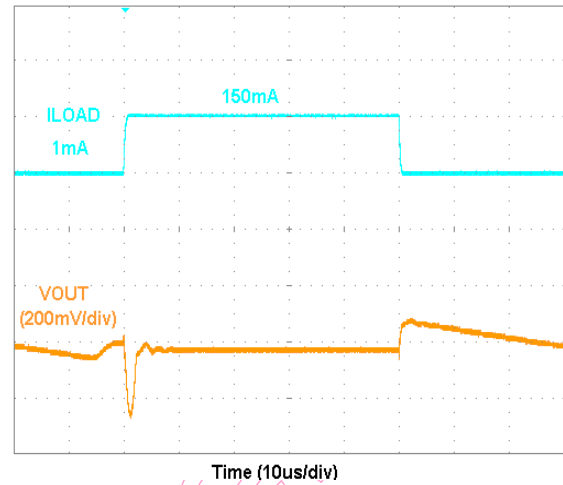

$V_{OUT}=2.8V$ ,  $I_{OUT}=50mA \sim 100mA \sim 50mA$ ,  $V_{DD}=3.8V$   
 $tr=tf=0.5\mu s$

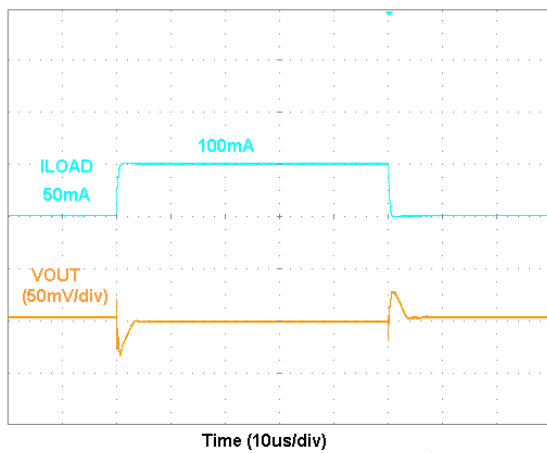

$V_{OUT}=2.8V$ ,  $I_{OUT}=1mA \sim 150mA \sim 1mA$ ,  $V_{DD}=3.8V$   
 $tr=tf=0.5\mu s$

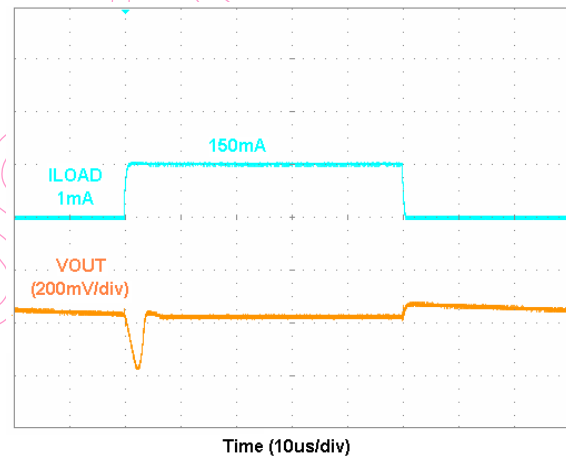

$V_{OUT}=3.0V$ ,  $I_{OUT}=50mA \sim 100mA \sim 50mA$ ,  $V_{DD}=4.0V$   
 $tr=tf=0.5\mu s$



$V_{OUT}=3.0V$ ,  $I_{OUT}=1mA \sim 150mA \sim 1mA$ ,  $V_{DD}=4.0V$   
 $tr=tf=0.5\mu s$



Turn On Speed with EN pin

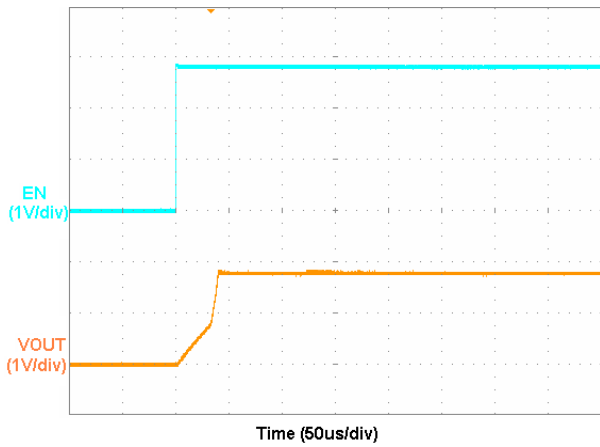

$V_{OUT}=1.8V, I_{OUT}=0MA, V_{DD}=2.8V$

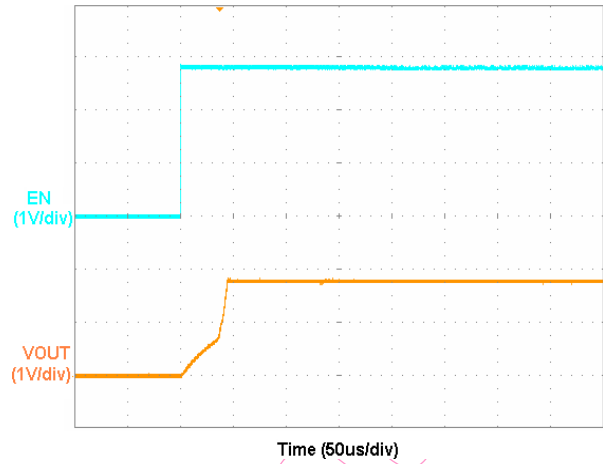

$V_{OUT}=1.8V, I_{OUT}=30MA, V_{DD}=2.8V$

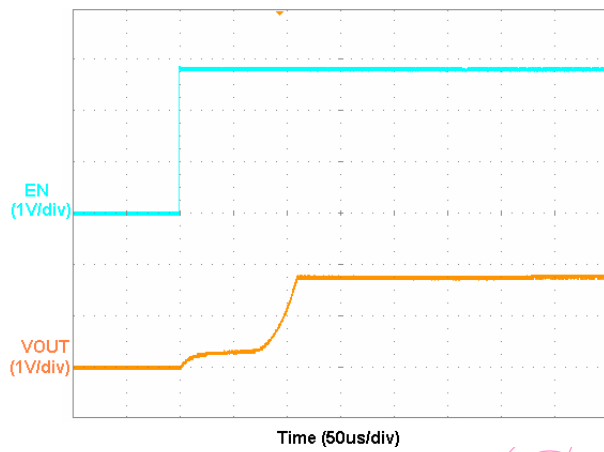

$V_{OUT}=1.8V, I_{OUT}=150MA, V_{DD}=2.8V$

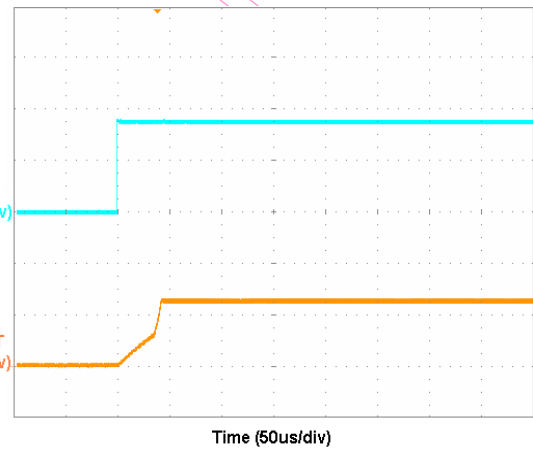

$V_{OUT}=2.5V, I_{OUT}=0MA, V_{DD}=3.5V$

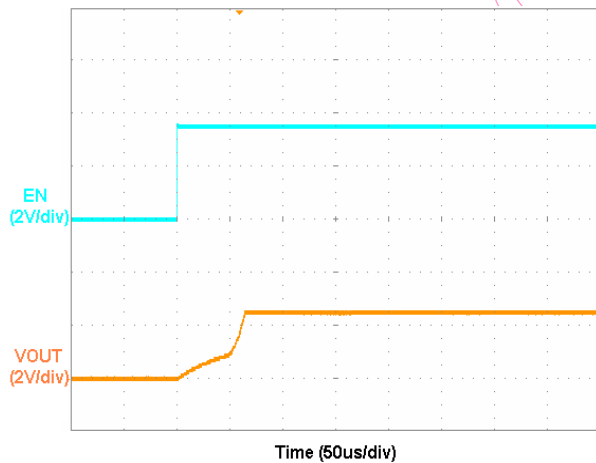

$V_{OUT}=2.5V, I_{OUT}=30MA, V_{DD}=3.5V$

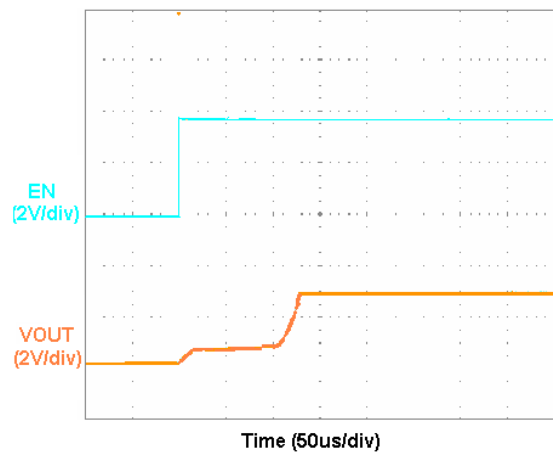

$V_{OUT}=2.5V, I_{OUT}=150MA, V_{DD}=3.5V$

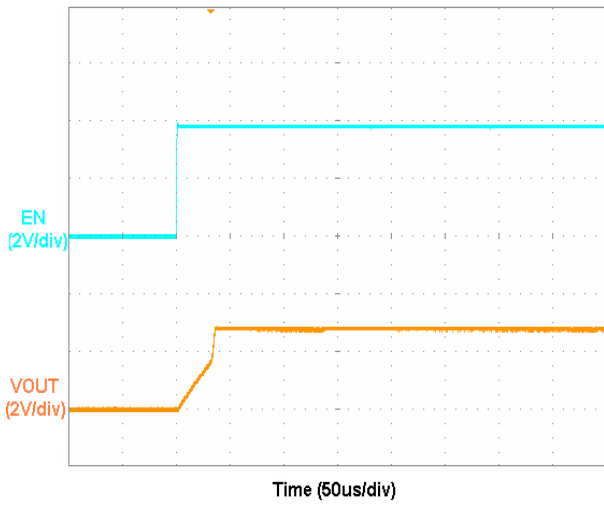

$V_{OUT}=2.8V, I_{OUT}=0mA, V_{DD}=3.8V$

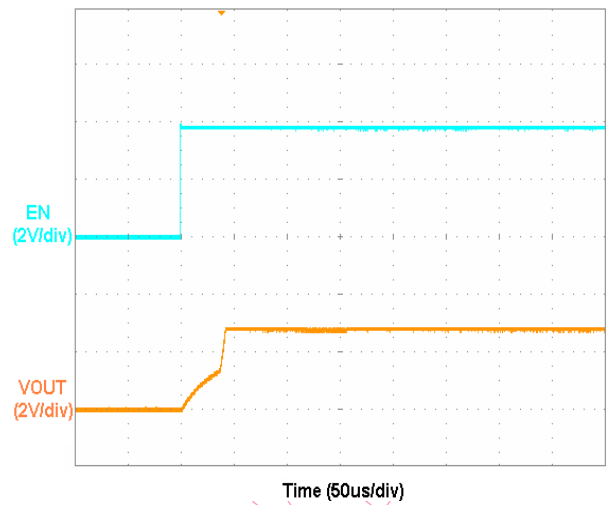

$V_{OUT}=2.8V, I_{OUT}=30mA, V_{DD}=3.8V$

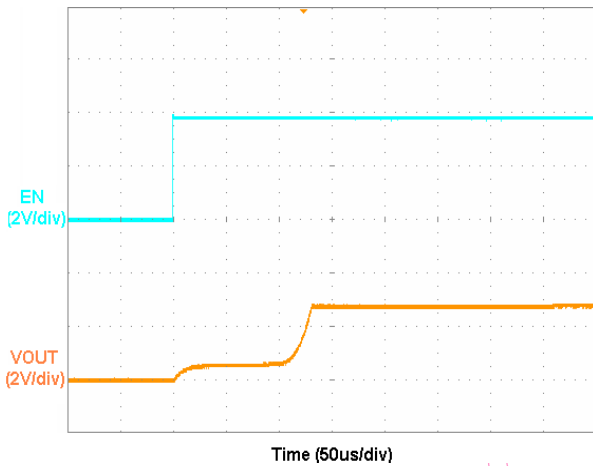

$V_{OUT}=2.8V, I_{OUT}=150mA, V_{DD}=3.8V$

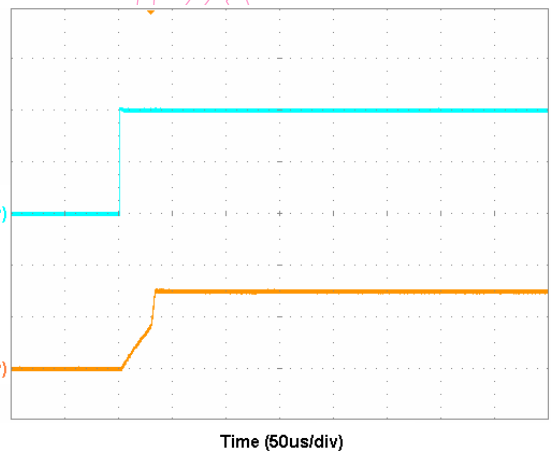

$V_{OUT}=3.0V, I_{OUT}=0mA, V_{DD}=4.0V$

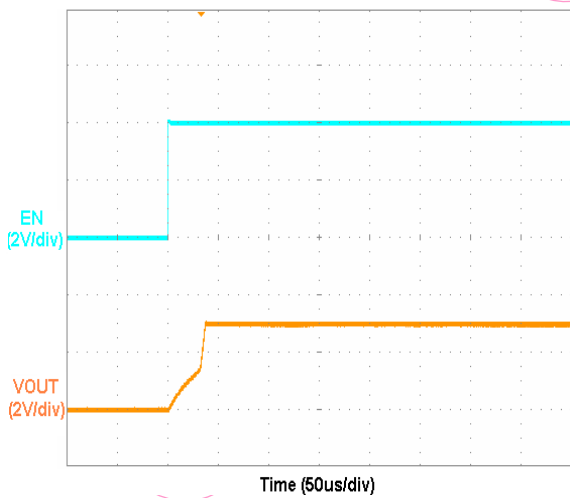

$V_{OUT}=3.0V, I_{OUT}=30mA, V_{DD}=4.0V$

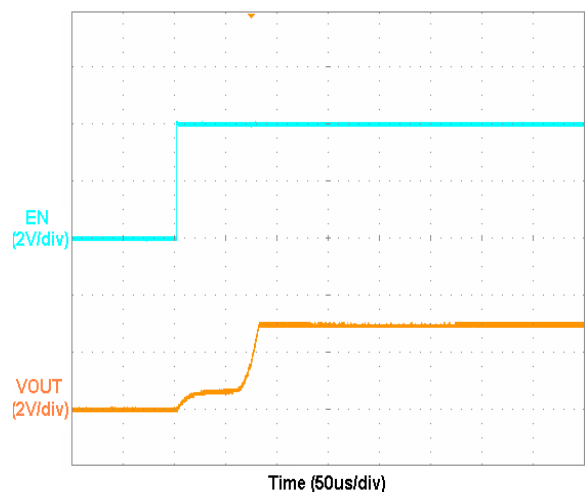

$V_{OUT}=3.0V, I_{OUT}=150mA, V_{DD}=4.0V$

### Turn Off Speed with EN pin



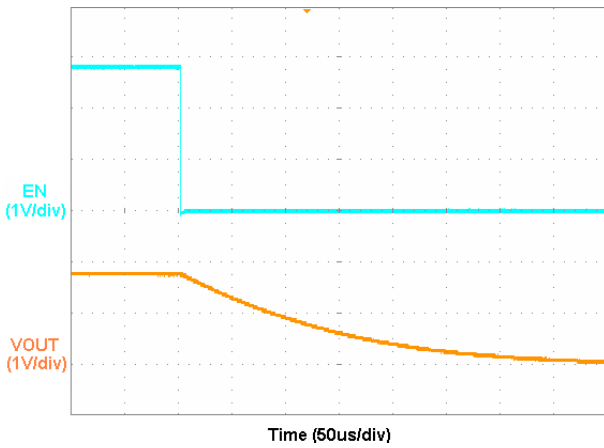

$V_{OUT}=1.8V, I_{OUT}=0mA, V_{DD}=2.8V$

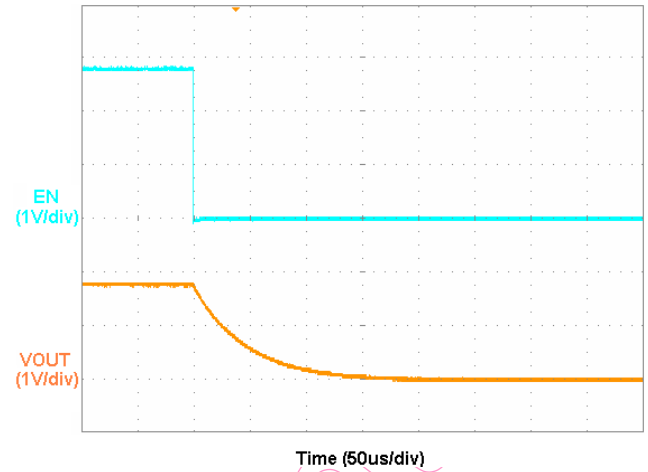

$V_{OUT}=1.8V, I_{OUT}=30mA, V_{DD}=2.8V$

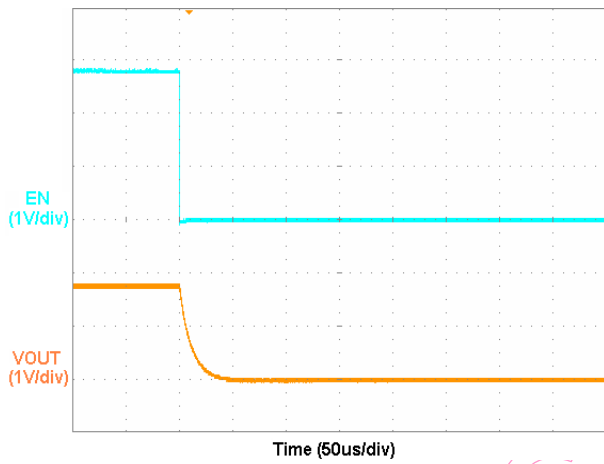

$V_{OUT}=1.8V, I_{OUT}=150mA, V_{DD}=2.8V$

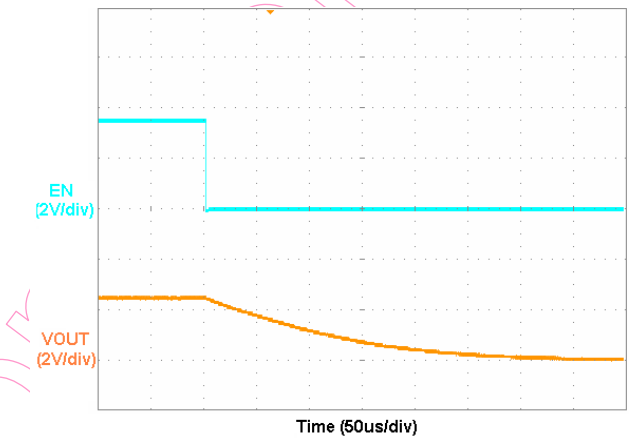

$V_{OUT}=2.5V, I_{OUT}=0mA, V_{DD}=3.5V$

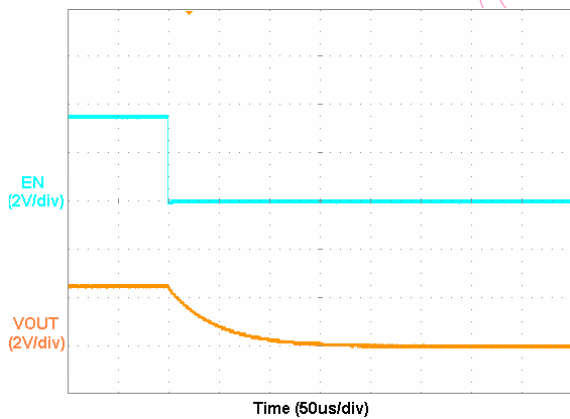

$V_{OUT}=2.5V, I_{OUT}=30mA, V_{DD}=3.5V$

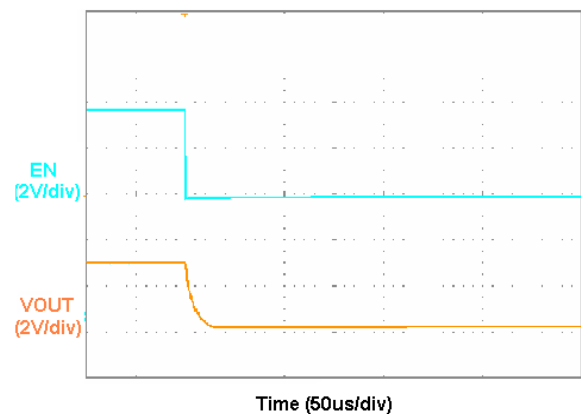

$V_{OUT}=2.5V, I_{OUT}=150mA, V_{DD}=3.5V$

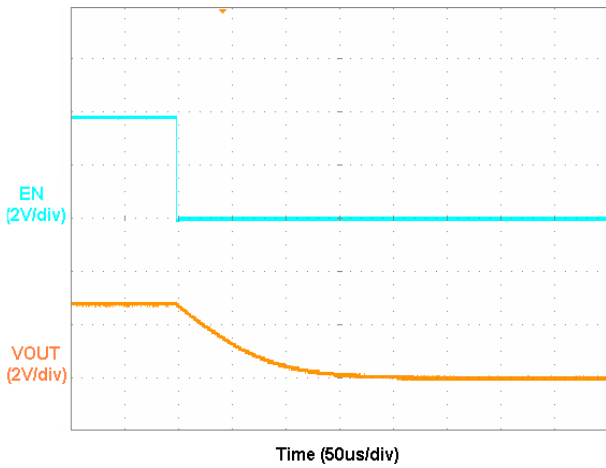

$V_{OUT}=2.8V, I_{OUT}=0mA, V_{DD}=3.8V$

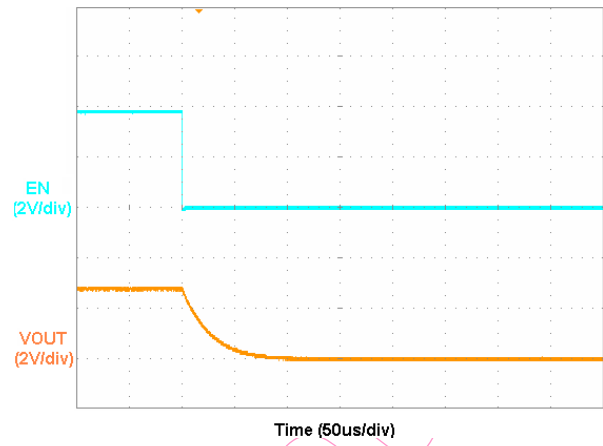

$V_{OUT}=2.8V, I_{OUT}=30mA, V_{DD}=3.8V$

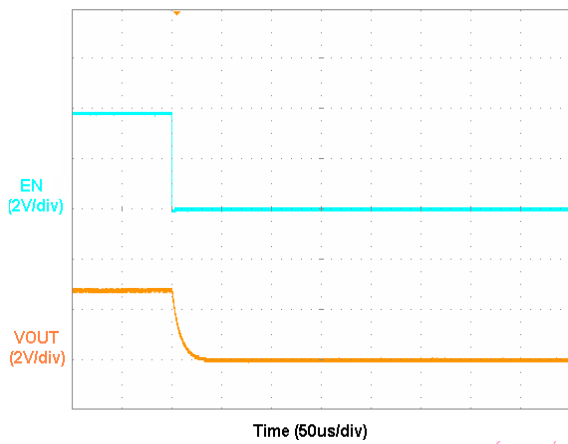

$V_{OUT}=2.8V, I_{OUT}=150mA, V_{DD}=3.8V$

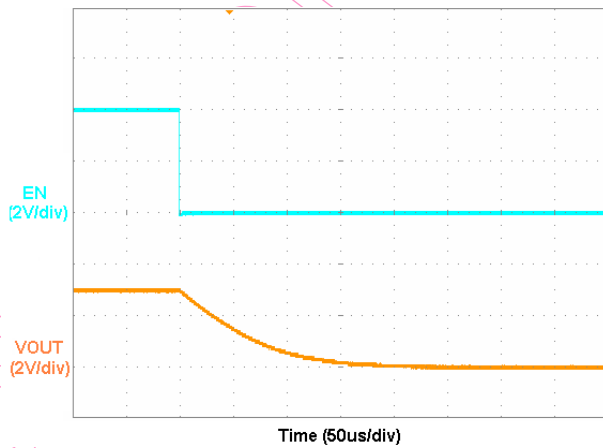

$V_{OUT}=3.0V, I_{OUT}=0mA, V_{DD}=4.0V$

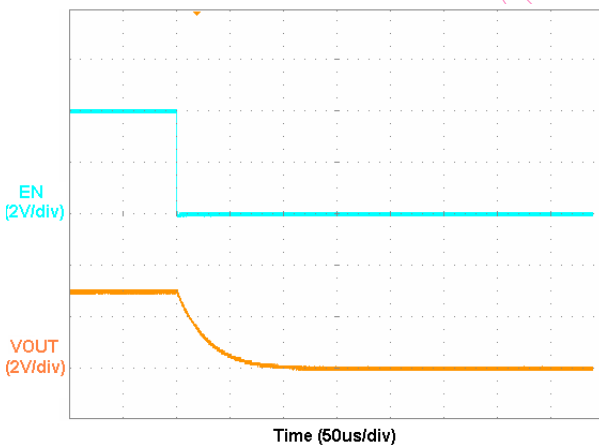

$V_{OUT}=3.0V, I_{OUT}=30mA, V_{DD}=4.0V$

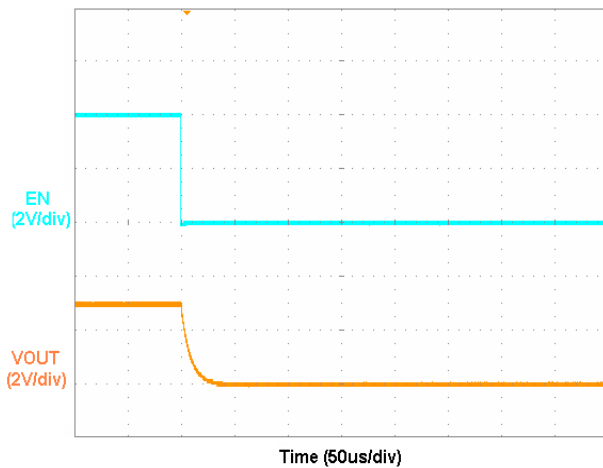

$V_{OUT}=3.0V, I_{OUT}=150mA, V_{DD}=4.0V$

### Dropout Voltage vs. Temperature

1.8v Dropout Voltage vs Temperature

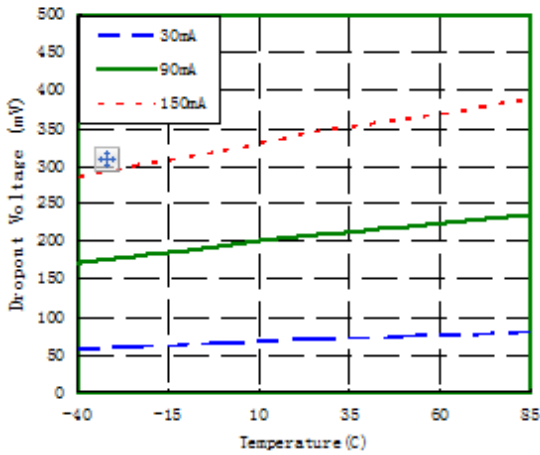

$V_{OUT}=1.8V, I_{OUT}=30mA, 90mA, 150mA$

2.5v Dropout Voltage vs Temperature

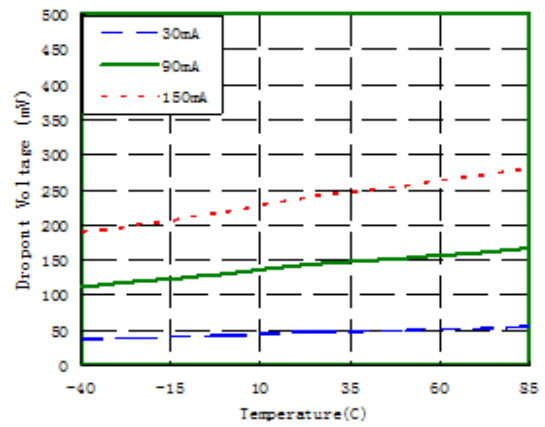

$V_{OUT}=2.5V, I_{OUT}=30mA, 90mA, 150mA$

2.8v Dropout Voltage vs Temperature

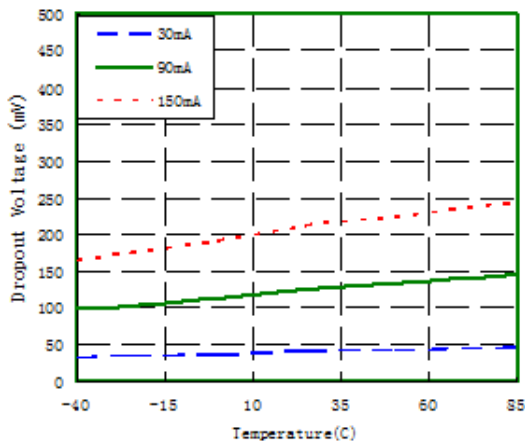

$V_{OUT}=2.8V, I_{OUT}=30mA, 90mA, 150mA$

3.0v Dropout Voltage vs Temperature

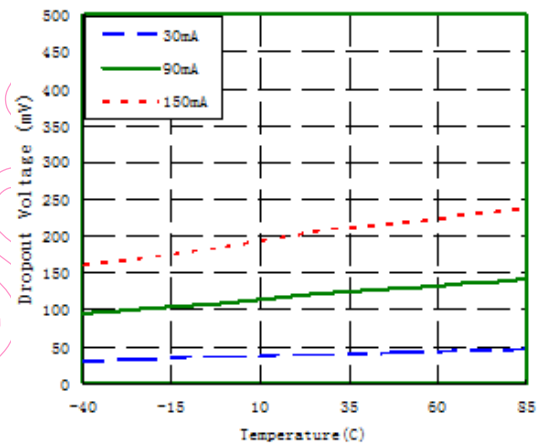

$V_{OUT}=3.0V, I_{OUT}=30mA, 90mA, 150mA$

## Application Information

### Enable

The GS7108 has a dedicated enable pin(EN). When the EN pin is in the logic low ( $V_{EN} < 0.3V$ ), the regulator will be turned off, reducing the supply current to less than 1uA.

When the EN pin is in the logic high ( $V_{EN} > 1.5V$ ), the regulator will be turned on. Left open, the EN pin is pulled down by a internal resistor to shut down the regulator.

### Current Limit

The GS7108 contains an independent current limit and short circuit current protection to prevent unexpected applications. The current limit monitors and controls the pass transistor's gate voltage, limiting the output current to higher than 260mA typical. When the output voltage is less than 0.4V, the short circuit current protection starts the current fold back function and maintains the loading current 35mA. The output can be shorted to ground indefinitely without damaging the part.

### Output Capacitor

The GS7108 is specifically designed to employ ceramic output capacitors as low as 0.47uF (X7R). The ceramic capacitors offer significant cost and space savings, along with high frequency noise filtering. Place the capacitors physically as close as possible to the device with wide and direct PCB traces.

Ceramic capacitors have different temperature characteristics and bias characteristics which depend on their dimensions and manufacturers. If the setting voltage is 2.5V or more and the capacitor's dimensions for  $V_{OUT}$  equal to 1.0mm by 0.5mm or smaller than that, the capacitance

value might be extremely low. As a result, the capacitance might be much less than expected value. In such cases, the operation might be unstable at low temperature ( $-25^{\circ}C$  or less). In that case, use a larger capacity, or a large dimensions' capacitor. (For example 1.6mm by 0.8mm)

### Input Capacitor

Good bypassing is recommended from input to ground to help improve AC performance. A 0.47uF (X7R) input capacitor or greater located as close as possible to the IC is recommended. Place the capacitors physically as close as possible to the device with wide and direct PCB traces.

### Power Dissipation and Layout Considerations

Excessive power dissipation may cause thermal overload, and hence the increase of the IC junction temperature beyond a safe operating level. For continuous operation, it is highly recommended to keep the junction temperature below the maximum operation junction temperature  $125^{\circ}C$  for maximum reliability.

The relationship between  $\theta_{JA}$  and  $T_{J(MAX)}$  can be calculated as:

$$P_{D(MAX)} = (T_{J(MAX)} - T_A) / \theta_{JA}$$

Where  $T_{J(MAX)}$  is the maximum operation junction temperature  $125^{\circ}C$ ,  $T_A$  is the ambient temperature and the  $\theta_{JA}$  is the junction to ambient thermal resistance.

The power dissipation definition in device is:

$$P_D = (V_{IN} - V_{OUT}) \times I_{OUT} + V_{DD} \times I_Q$$

As the above equations indicate, it is desirable to work ICs whose  $\theta_{JA}$  values are small such that  $T_{J(MAX)}$  does not increase strongly with  $P_D$ . To

avoid thermally overloading the GS7108, refrain from exceeding the absolute maximum junction temperature rating of 150°C under continuous operating condition. Overstressing the regulator with high loading currents and elevated input-to-output differential voltages can increase

the IC die temperature significantly.

GStek Confidential

## Package Dimensions, uDFN4-1x1

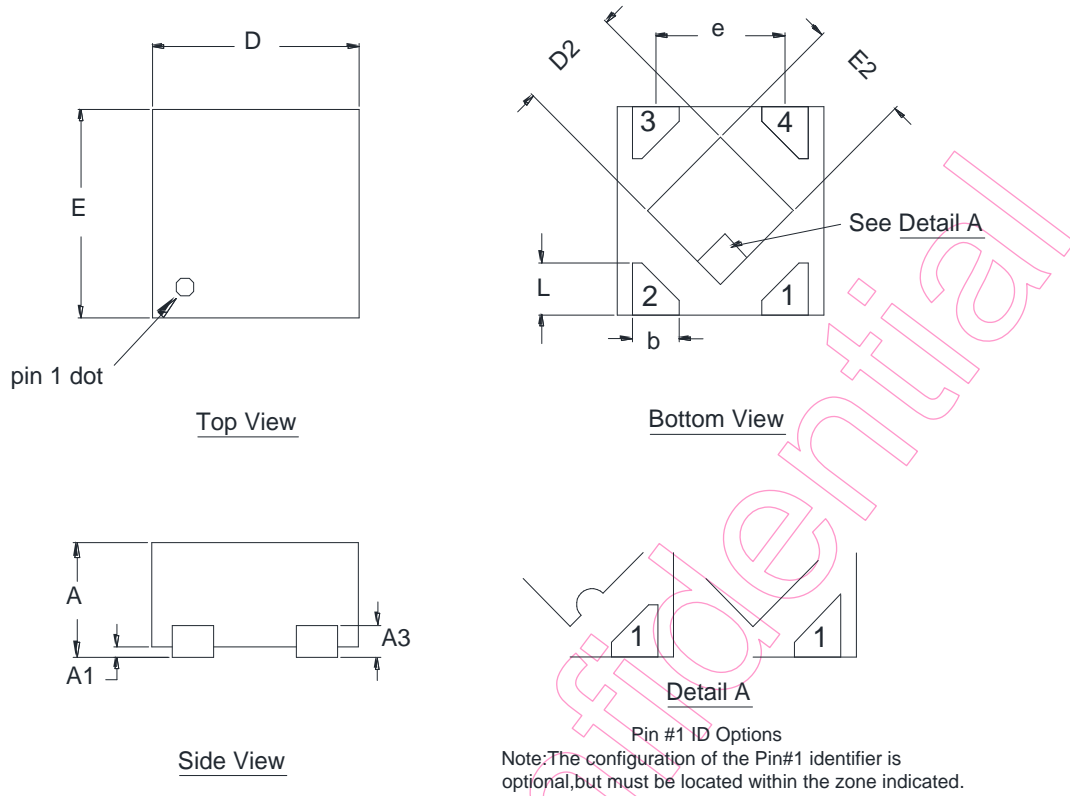

| Symbol | Dimensions in Millimeters |       |
|--------|---------------------------|-------|
|        | Min                       | Max   |
| A      | 0.45                      | 0.60  |
| A1     | 0.00                      | 0.05  |
| A3     | 0.10                      | 0.152 |
| b      | 0.15                      | 0.30  |
| D      | 0.90                      | 1.10  |
| D2     | 0.40                      | 0.60  |
| E      | 0.90                      | 1.10  |
| E2     | 0.40                      | 0.60  |
| e      | 0.65 REF.                 |       |
| L      | 0.20                      | 0.30  |

### Note

- 1.Min.: Minimum dimension specified.
- 2.Max.: Maximum dimension specified.
- 3.REF.: Reference. Normal/Regular dimension specified for reference.

## Package Dimensions, SOT-23-5

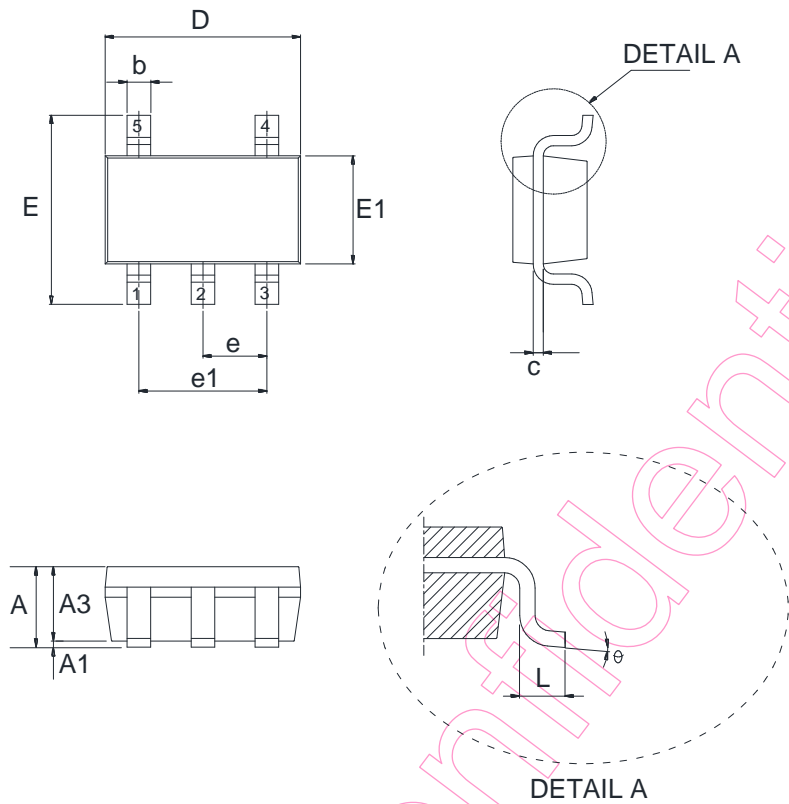

| Symbol | Dimensions in Millimeters |      |
|--------|---------------------------|------|
|        | Min.                      | Max. |
| A      | 0.90                      | 1.45 |
| A1     | 0.00                      | 0.15 |
| A3     | 0.90                      | 1.30 |
| b      | 0.30                      | 0.50 |
| c      | 0.08                      | 0.25 |
| e      | 0.95 REF.                 |      |
| e1     | 1.90 REF.                 |      |
| D      | 2.90 REF.                 |      |
| E      | 2.80 REF.                 |      |
| E1     | 1.60 REF.                 |      |
| L      | 0.30                      | 0.60 |
| θ      | 0°                        | 8°   |

**Note**

- 1.Min.: Minimum dimension specified.
- 2.Max.: Maximum dimension specified.
- 3.REF.: Reference. Normal/Regular dimension specified for reference.

## Package Dimensions, SC-82

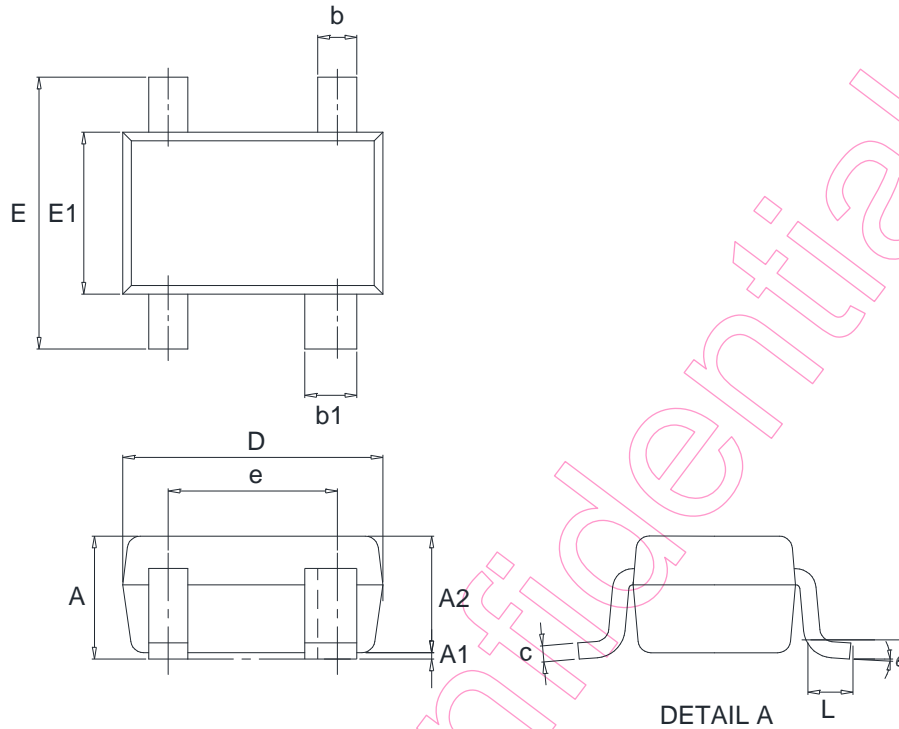

| Symbol | Dimensions in Millimeters |      |
|--------|---------------------------|------|
|        | Min                       | Max  |
| A      | 0.70                      | 1.10 |
| A1     | 0.00                      | 0.10 |
| A2     | 0.70                      | 1.00 |
| b      | 0.15                      | 0.40 |
| b1     | 0.30                      | 0.50 |
| c      | 0.08                      | 0.26 |
| e      | 1.30 REF.                 |      |
| D      | 1.80                      | 2.20 |
| E      | 1.80                      | 2.45 |
| E1     | 1.15                      | 1.45 |
| L      | 0.36 REF.                 |      |
| θ      | 0°                        | 10°  |

**Note**

- 1.Min: Minimum dimension specified.
- 2.Max: Maximum dimension specified.
- 3.REF.: Reference. Normal/Regular dimension specified for reference.



## Package Dimensions, MSOT-23

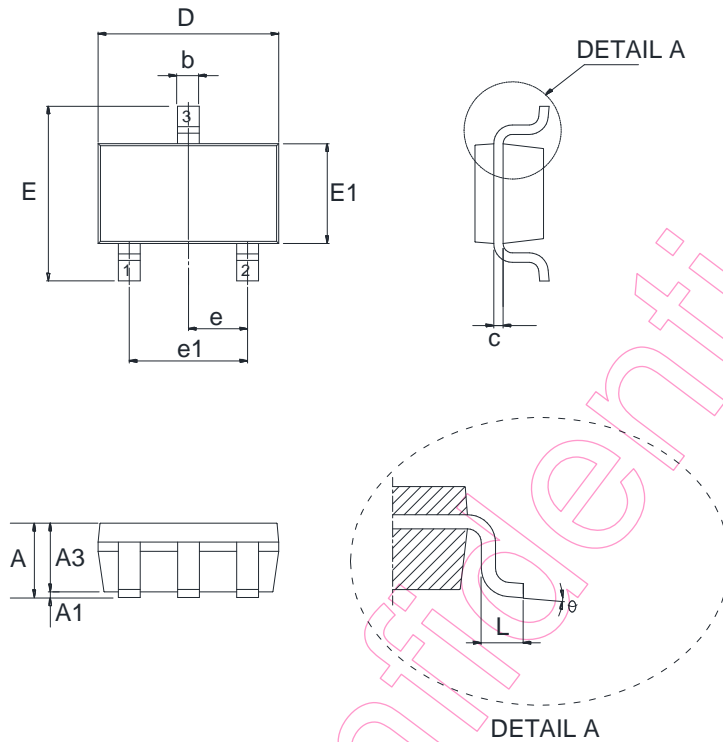

| Symbol | Dimensions in Millimeters |      |
|--------|---------------------------|------|
|        | Min.                      | Max. |
| A      | 0.90                      | 1.15 |
| A1     | 0.00                      | 0.10 |
| A2     | 0.90                      | 1.05 |
| b      | 0.30                      | 0.50 |
| c      | 0.08                      | 0.15 |
| e      | 0.95 REF.                 |      |
| e1     | 1.90 REF.                 |      |
| D      | 2.90 REF.                 |      |
| E      | 2.40 REF.                 |      |
| E1     | 1.30 REF.                 |      |
| L      | 0.30                      | 0.50 |
| θ      | 0°                        | 8°   |

**Note:**

1. Min.: Minimum dimension specified.
2. Max.: Maximum dimension specified.
3. REF.: Reference. Normal/Regular dimension specified for reference.

## DISCLAIMERS

**Please read the notice stated in this preamble carefully before Admission e accessing any contents of the document attached. Admission of GStek's statement therein is presumed once the document is released to the receiver.**

Notice:

*Firstly, GREEN SOLUTION CO., LTD. (GStek) reserves the right to make corrections, modifications, enhancements, improvements, and other changes to its information herein without notice.. And the aforesaid information does not form any part or parts of any quotation or contract between GStek and the information receiver.*

*Further, no responsibility is assumed for the usage of the aforesaid information. GStek makes no representation that the interconnect of its circuits as described herein will not infringe on exiting or future patent rights and other intellectual property rights, nor do the descriptions contained herein express or imply that any licenses under any GStek patent right, copyright, mask work right, or other GStek intellectual property right relating to any combination, machine, or process in which GStek products or services are used.*

*Besides, the product in this document is not designed for use in life support appliances, devices, or systems where malfunction of this product can reasonably be expected to result in personal injury. GStek customers' using or selling this product for use in such applications shall do so at their own risk and agree to fully indemnify GStek for any damage resulting from such improper use or sale.*

*At last, the information furnished in this document is the property of GStek and shall be treated as highly confidentiality; any kind of distribution, disclosure, copying, transformation or use of whole or parts of this document without duly authorization from GStek by prior written consent is strictly prohibited. The receiver shall fully compensate GStek without any reservation for any losses thereof due to its violation of GStek's confidential request. The receiver is deemed to agree on GStek's confidential request therein suppose that said receiver receives this document without making any expressly opposition. In the condition that aforesaid opposition is made, the receiver shall return this document to GStek immediately without any delay.*