

VOCs Sensor

- for the detection of Formaldehyde
Toluene, Organic Solvent
- Semi conductor type,



General

It is applied detection of VOCs gases (Toluene, formaldehyde, Benzene, ect.)

Application : Ventilator, Air cleaner, Hood.

Operation range

- Working temperature : - 10 ~ 50
- Working humidity : below saturation point
- Storage temperature : -20 ~ 80

1. Sensitivity Characteristic Slope (= $R_{s,gas} / R_{s,air}$)

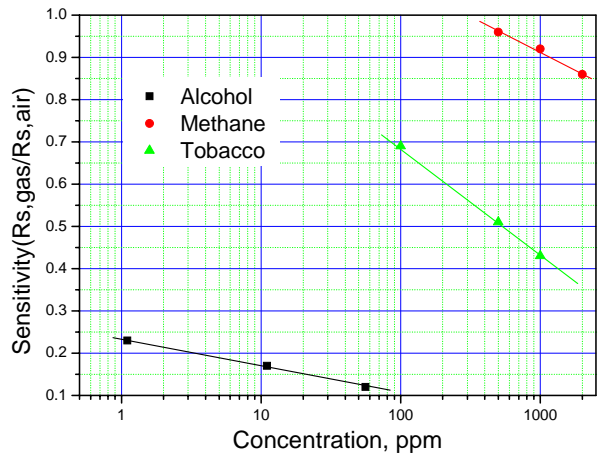
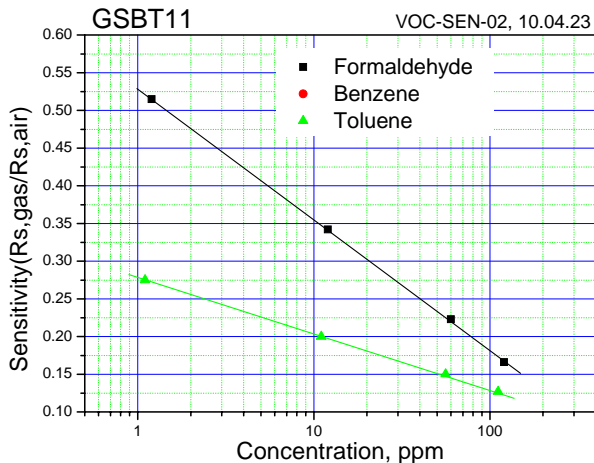

2. Basic Measuring Circuit Stability

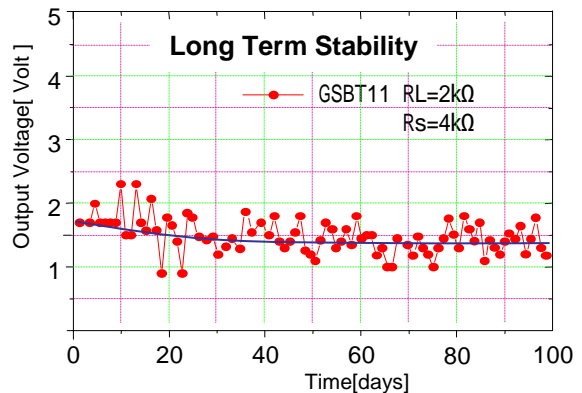
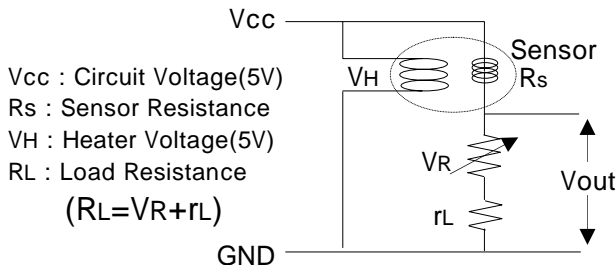

3. Specifications

3.1 Package (Transducer or sensor)



a. Characteristics

| Index | | Spec. & Test condition | | | | | |
|---|--|--|------|----------------|------|----------|------|
| Circuit Voltage | Vc | Sensor input Voltage : 1 ~ 12Volt, Sensor Resistance : refer to Rank table | | | | | |
| | VH | Heater input voltage : 5volt±1%, Heater Resistance : 31.0 ±0.2 | | | | | |
| | PH | Power consumption : Less than 370mW, Inrush current : Less than 200mA | | | | | |
| Characteristics of sensitivity () (Rs,gas / Rs,air) | Gases | Toluene | | H ₂ | | i-butane | |
| | Concentration | 1.0 ppm | | 100ppm | | 100ppm | |
| | Sensitivity | 0.30 | 0.60 | 0.35 | 0.70 | 0.20 | 0.50 |
| Guarantee | - 3years - Calibration interval 1years recommended | | | | | | |
| Operating environment | - Temp. : -10 ~ 50 , Humidity : 5 ~ 90%RH, Non-condensing - Storage → Temp. : -10 ~ 70 , Humidity : 0 ~ 90%RH | | | | | | |
| Reaction time(T90) | - Reaction Time(T90) : Less then 10sec - Recovering Time(T90) : Less then 30sec | | | | | | |

*TMA : Trimethylamine, *T90 : 90% of saturation point

*Sensitivity () = Rs,gas / Rs,air

- Rs,gas : output resistance after gas inlet, - Rs,air : output resistance in special air

b. Output (Vout)

* Formulation of **Toluene**

$$\text{Log(ppm)} = (-2.610) + 1.774 * (\text{Vout}) + (-0.171) * (\text{Vout})^2$$

* Formulation of **Formaldehyde**

$$\text{Log(ppm)} = (-8.188) + 10.093 * (\text{Vout}) + (-2.363) * (\text{Vout})^2$$

* Formulation of **Benzene**

$$\text{Log(ppm)} = ((\text{Vout}) - 0.972) / 0.22923$$

Hydrogen(090924)

| ppm | Vout | ppm | Vout | ppm | Vout |
|-----|------|-----|------|-----|------|
| 0 | 0.64 | 24 | 2.30 | 48 | 3.14 |
| 2 | 0.72 | 26 | 2.38 | 50 | 3.20 |
| 4 | 1.03 | 28 | 2.46 | 52 | 3.25 |
| 6 | 1.25 | 30 | 2.54 | 54 | 3.31 |
| 8 | 1.42 | 32 | 2.61 | 56 | 3.37 |
| 10 | 1.57 | 34 | 2.68 | 58 | 3.43 |
| 12 | 1.70 | 36 | 2.75 | 60 | 3.48 |
| 14 | 1.82 | 38 | 2.82 | 62 | 3.53 |
| 16 | 1.93 | 40 | 2.89 | 64 | 3.59 |
| 18 | 2.03 | 42 | 2.95 | 66 | 3.64 |
| 20 | 2.13 | 44 | 3.01 | 68 | 3.69 |
| 22 | 2.22 | 46 | 3.08 | 70 | 3.75 |

Toluene(090924)

| ppm | Volt | ppm | Volt |
|-----|------|-----|------|
| 0 | 1.00 | 24 | 3.27 |
| 2 | 2.10 | 26 | 3.33 |
| 4 | 2.33 | 28 | 3.38 |
| 6 | 2.49 | 30 | 3.44 |
| 8 | 2.62 | 32 | 3.49 |
| 10 | 2.73 | 34 | 3.54 |
| 12 | 2.83 | 36 | 3.59 |
| 14 | 2.92 | 38 | 3.64 |
| 16 | 3.00 | 40 | 3.69 |
| 18 | 3.07 | 42 | 3.74 |
| 20 | 3.14 | 44 | 3.78 |
| 22 | 3.20 | 46 | 3.82 |

Formaldehyde(090924)

| ppm | Volt | ppm | Volt |
|-----|------|-----|------|
| 0 | 1.00 | 24 | 1.42 |
| 2 | 1.16 | 26 | 1.43 |
| 4 | 1.22 | 28 | 1.44 |
| 6 | 1.26 | 30 | 1.45 |
| 8 | 1.29 | 32 | 1.46 |
| 10 | 1.31 | 34 | 1.47 |
| 12 | 1.33 | 36 | 1.47 |
| 14 | 1.35 | 38 | 1.48 |
| 16 | 1.37 | 40 | 1.49 |
| 18 | 1.38 | 42 | 1.50 |
| 20 | 1.40 | 44 | 1.50 |
| 22 | 1.41 | 46 | 1.51 |

c. Sensor connection

- Be connected to "Basic measuring circuit('2')" after select Sensor resistance (Rs) and RL (reference '3.1 - b')

d. Product code

G S B T 1 1 - D

- D03 : D->Rank No. (Sensor Resistance)
- 03->Rank Grade (Sensor resistance)
- in special air

e. Output Curve

- Error : $\pm 15\%$
- No compensation of Humidity & temperature
- Stand. \rightarrow RL : 3.9k Ω , Sensor resistance : 15.6k Ω
- Vout,air : 1.0volt (input voltage 5volt)

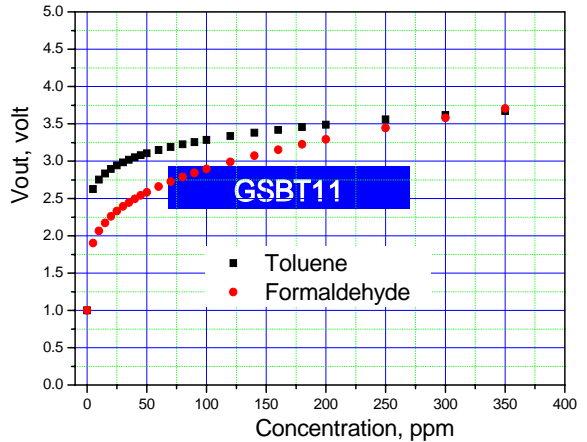

f. Sensor Resistance (Only package)

- Sensor Resistance Table(Only package)

| Rank No. | D Rank Table (k Ω) | | |
|----------|----------------------------|-----------|----------|
| | RL | Low limit | Hi limit |
| D04 | 0.95 | 3.38 | 4.29 |
| D05 | 1.21 | 4.29 | 5.46 |
| D06 | 1.54 | 5.46 | 6.95 |
| D07 | 1.96 | 6.95 | 9.04 |
| D08 | 2.55 | 9.04 | 11.6 |
| D09 | 3.24 | 11.6 | 14.8 |
| D11 | 5.23 | 18.8 | 23.8 |
| D11 | 5.23 | 18.8 | 23.8 |

Rank Table No.:D(1 \pm 0.2Volt)

| Rank No. | D Rank Table (k Ω) | | |
|----------|----------------------------|-----------|----------|
| | RL | Low limit | Hi limit |
| D12 | 6.65 | 23.8 | 30.3 |
| D13 | 8.45 | 30.3 | 38.5 |
| D14 | 10.7 | 38.5 | 48.7 |
| D15 | 13.7 | 48.7 | 62.4 |
| D16 | 17.4 | 62.4 | 79.3 |
| D17 | 22.1 | 79.3 | 101 |
| D18 | 28.0 | 101 | 128 |
| D19 | 35.7 | 128 | 163 |

g. Structure and Dimensions

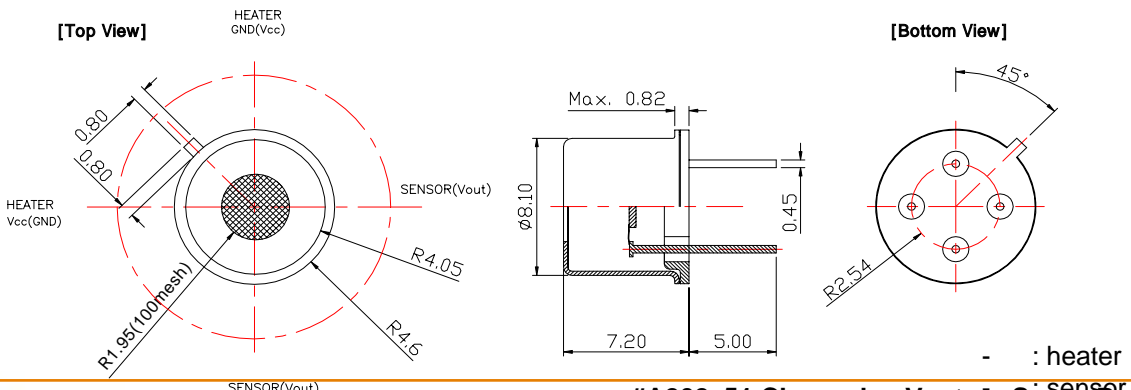

3.2 OP Module (GSBT11-P1xx), MOQ : None



a. Characteristics

| Index | | Spec. & Test condition |
|--------------------|----|---|
| Circuit Voltage | Vc | Module input Voltage : 5±0.1Volt |
| | PH | Power consumption : 460mW , Inrush current : Less than 140mA |
| Guarantee | | - 3years over - Calibration interval 1years recommended |
| Worm up Time (T90) | | - More then 300sec |
| Reaction time(T90) | | - Reaction Time(T90) : Less then 5sec - Recovering Time(T90) : Less then 30sec |

b. Output data

- Output data : 0.5 ~ 5Volt
- Relay Output : Mere than 4.0Volt
- Tolerance : ±7% (at 25±2, 60±5%RH)

Toluene, Formaldehyde

- Toluene

$$(ppm) = 10^{(-2.071+0.672*(VOLT))}$$

- Formaldehyde

$$(ppm) = 10^{(-0.867+1.274*(VOLT))}$$

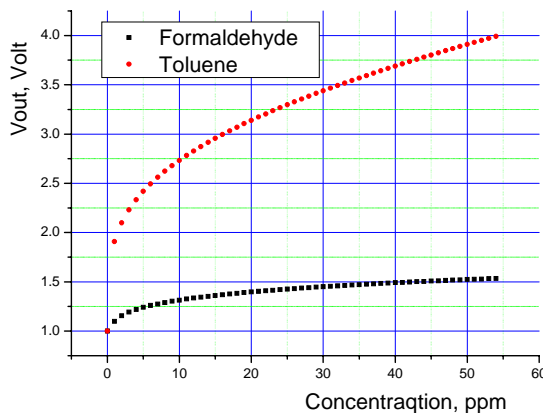

| [Toluene] | | | | | | [Hydrogen] | | | | | |
|-------------|-------------|----------|-------------|----------|-------------|--------------|-------------|----------|-------------|----------|-------------|
| Con. Ppm | Output Vout | Con. Ppm | Output Vout | Con. ppm | Output Vout | Con. ppm | Output Vout | Con. ppm | Output Vout | Con. ppm | Output Vout |
| 0.0 | 0.64 | 1.2 | 3.13 | 2.4 | 3.65 | 0 | 0.64 | 24 | 2.30 | 48 | 3.14 |
| 0.1 | 1.86 | 1.3 | 3.19 | 2.5 | 3.69 | 2 | 0.72 | 26 | 2.38 | 50 | 3.20 |
| 0.2 | 2.14 | 1.4 | 3.24 | 2.6 | 3.72 | 4 | 1.03 | 28 | 2.46 | 52 | 3.25 |
| 0.3 | 2.33 | 1.5 | 3.29 | 2.7 | 3.75 | 6 | 1.25 | 30 | 2.54 | 54 | 3.31 |
| 0.4 | 2.48 | 1.6 | 3.34 | 2.8 | 3.78 | 8 | 1.42 | 32 | 2.61 | 56 | 3.37 |
| 0.5 | 2.60 | 1.7 | 3.38 | 2.9 | 3.82 | 10 | 1.57 | 34 | 2.68 | 58 | 3.43 |
| 0.6 | 2.70 | 1.8 | 3.42 | 3.0 | 3.85 | 12 | 1.70 | 36 | 2.75 | 60 | 3.48 |
| 0.7 | 2.79 | 1.9 | 3.47 | 3.1 | 3.87 | 14 | 1.82 | 38 | 2.82 | 62 | 3.53 |
| 0.8 | 2.87 | 2.0 | 3.51 | 3.2 | 3.90 | 16 | 1.93 | 40 | 2.89 | 64 | 3.59 |
| 0.9 | 2.94 | 2.1 | 3.54 | 3.3 | 3.93 | 18 | 2.03 | 42 | 2.95 | 66 | 3.64 |
| 1.0 | 3.01 | 2.2 | 3.58 | 3.4 | 3.96 | 20 | 2.13 | 44 | 3.01 | 68 | 3.69 |
| 1.1 | 3.07 | 2.3 | 3.62 | 3.5 | 3.99 | 22 | 2.22 | 46 | 3.08 | 70 | 3.75 |

c. Structure and Dimensions

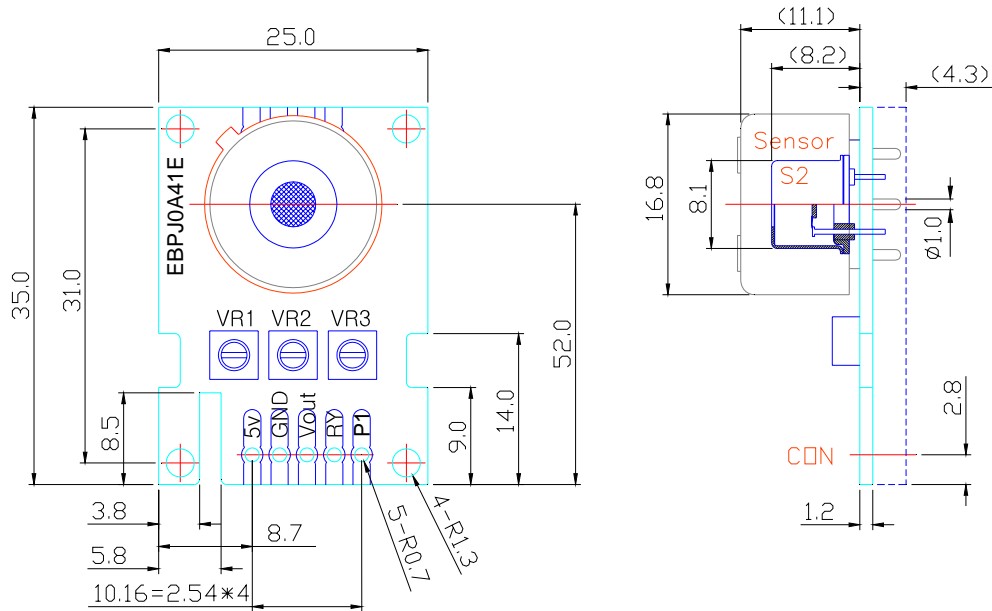

- VR1 : Control of Ra,air reference Value
- VR2 : Gain (Sensitivity control)
- VR3 : Offset (Level shift)

d. Data output

- Vcc : 5.0volt
- GND
- Data(Vout, analogue signal)
- Relay

e. Relay Output

- Max. output range H2 340ppm : Hi(4.0~4.1volt) output at 70ppm(H2)
- : Hi(4.0~4.1volt) output at 480ppm(Smoke)



3.3 RL Module(GSBT11-P3xx), MOQ :More than 500pcs

a. Characteristics

| Index | | Spec. & Test condition |
|--------------------------------|----|--|
| Circuit Voltage | Vc | Module input Voltage : 5 ± 0.1 Volt |
| | PH | Power consumption : Less than 450mW, Inrush current : Less than 140mA |
| Characteristics of Output data | | Refer to datasheet |
| Guarantee | | - 2years over - Calibration interval 1years recommended |
| Operating environment | | - Temp. : -10 ~ 50 , Humidity : 5 ~ 90%RH, Non-condensing - Storage → Temp. : -20 ~70 , Humidity : 0 ~90%RH |
| Reaction time(T90) | | - Reaction Time(T90) : Less then 10sec - Recovering Time(T90) : Less then 180sec |

b. Output data

Ref. → RL : 100kΩ, Sensor resistance : 400kΩ

Vout,air : 1.0volt (Input voltage 5volt)

- Tolerance : $\pm 10\%$ (at $25 \pm 2, 60 \pm 5\%$ RH)

Toluene, Formaldehyde

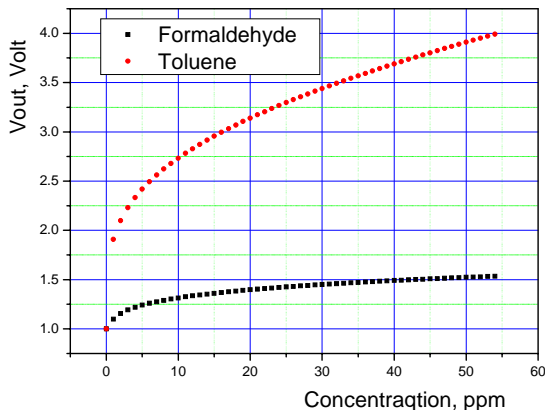

| [Toluene] | | | | | | Formaldehyde | | | |
|-------------|-------------|----------|-------------|----------|-------------|--------------|-------------|----------|-------------|
| Con. ppm | Output Vout | Con. ppm | Output Vout | Con. ppm | Output Vout | Con. ppm | Output Vout | Con. ppm | Output Vout |
| 0.0 | 0.64 | 1.2 | 3.13 | 2.4 | 3.65 | 0 | 1.00 | 24 | 1.42 |
| 0.1 | 1.86 | 1.3 | 3.19 | 2.5 | 3.69 | 2 | 1.16 | 26 | 1.43 |
| 0.2 | 2.14 | 1.4 | 3.24 | 2.6 | 3.72 | 4 | 1.22 | 28 | 1.44 |
| 0.3 | 2.33 | 1.5 | 3.29 | 2.7 | 3.75 | 6 | 1.26 | 30 | 1.45 |
| 0.4 | 2.48 | 1.6 | 3.34 | 2.8 | 3.78 | 8 | 1.29 | 32 | 1.46 |
| 0.5 | 2.60 | 1.7 | 3.38 | 2.9 | 3.82 | 10 | 1.31 | 34 | 1.47 |
| 0.6 | 2.70 | 1.8 | 3.42 | 3.0 | 3.85 | 12 | 1.33 | 36 | 1.47 |
| 0.7 | 2.79 | 1.9 | 3.47 | 3.1 | 3.87 | 14 | 1.35 | 38 | 1.48 |
| 0.8 | 2.87 | 2.0 | 3.51 | 3.2 | 3.90 | 16 | 1.37 | 40 | 1.49 |
| 0.9 | 2.94 | 2.1 | 3.54 | 3.3 | 3.93 | 18 | 1.38 | 42 | 1.50 |
| 1.0 | 3.01 | 2.2 | 3.58 | 3.4 | 3.96 | 20 | 1.40 | 44 | 1.50 |
| 1.1 | 3.07 | 2.3 | 3.62 | 3.5 | 3.99 | 22 | 1.41 | 46 | 1.51 |

c. Structure and Dimensions

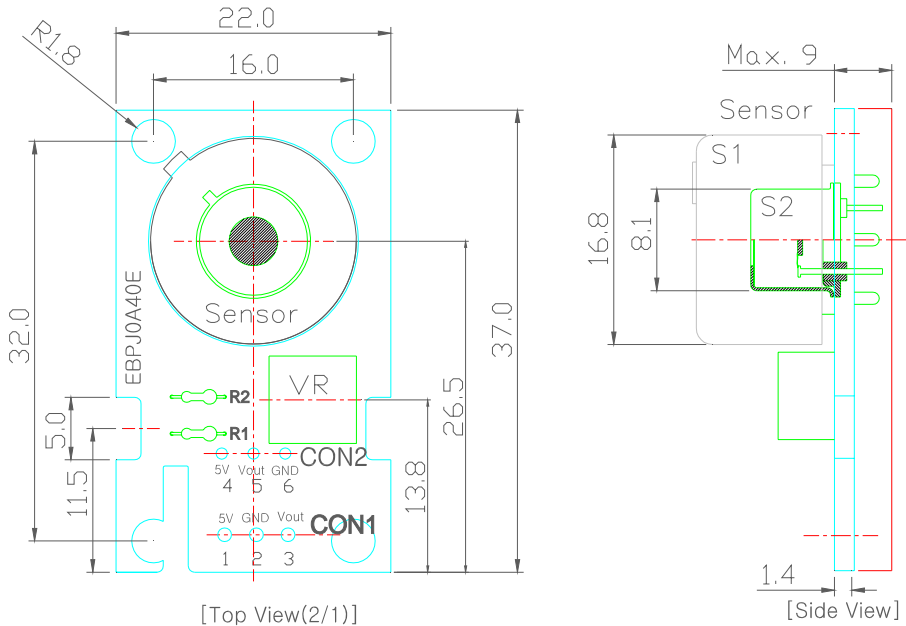

d. Data output (Note CON1, CON2 connection)

CON1

CON2

- , → Vcc : 5.0volt
- , → GND
- , → Data(Vout, analogue signal)

3.4 Product code & characteristics

| Product code | Consumption | Circuit | Output | Worm-up time |
|---------------|-------------|---------------|--|--------------|
| GSBT11 – P1XX | 390mW | OP-Amplifying | Data : Analogue Relay : Hi(4V), Low(0V) | Long |
| Study - P2XX | | μ-processor | Data : Digital Open collect | short |
| GSBT11 - P3XX | | | Data : Analogue | Long |

4. Product Index

| Index | GSBT11 | GSBT11-P11X | GSBT11-P21X ^{study} | GSBT11-P3XX |
|-------------------|---------------|-------------|------------------------------|-----------------|
| Circuit | Package | OP -Module | MP -Module | RL -Module |
| Target Gas | TVOC Gas | | | |
| Accuracy | ±15% | ±7% | ±5% | ±10% |
| Measuring Circuit | Basic Circuit | Op -Amp | Micro Processor | Basic Circuit |
| Input Voltage | 5Volt±3% | ← | ← | ← |
| Output | 0 ~ 5volt | 0 ~ 4.5volt | Open collect | 0 ~ 4.5volt |
| MOQ | None | None | None | More than 500ea |

5. Reaction time(T90)

Reaction Time(T90) : Less then 10sec
[Between Rs,air_b & Rs,gas]

Recovering Time(T90) : Less then 30sec
[between Rs,gas & Rs,air_a]

Beginning stability time(T90) : Less then 10 min

Rs,air_b : Sensor Resistance without gases
Rs,gas : Sensor Resistance after blowing gases
Rs,air_a : Sensor Resistance removing gases

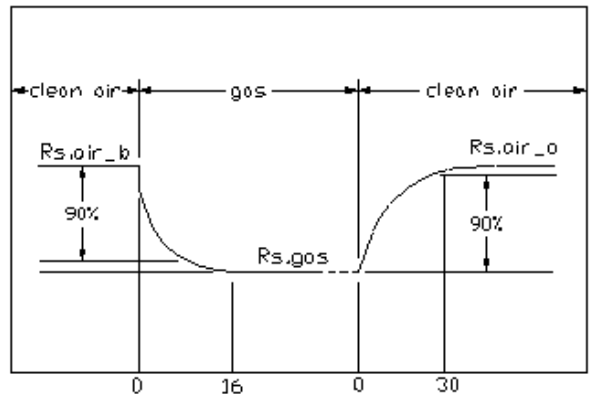

6. Application

- 6.1 Hood, Ventilator, Damper, Gas Leak Alarm (Explosive gases)
- 6.2 When soldering, certainly avoid the flux.
- 6.3 If using Epoxy PCB(FR4), the sensor is floated 2 3mm from PCB ground.

7. Product code

GSBT11 - P

(1) (2) (3) (4)

- (1) GSBT11 → VOCs Sensor
- (2) Division Circuit → 1 : Op-amp circuit 2 : Micro processor Circuit 3:Micro-processor
- (3) Gas sensing range → 1: Standard
- (4) Connector → 0:None