

GSC103A Dual Operational Amplifier and Voltage Reference

Description

The GSC103A is a monolithic IC that includes one independent op-amp and another op-amp for which the non inverting input is wired to a 2.5V fixed Voltage Reference. This device is offering space and cost saving in many applications like power supply management or data acquisition system.

Operational Amplifier

- Low Input Offset Voltage: 0.5mV(typ.)
- Low Supply Current :350uA/op. (@V_{CC}=5V)
- Medium Bandwidth (unity gain) : 0.9MHz
- Large Output Voltage Swing: 0V to (V_{CC}-1.5V)
- Input Common Mode voltage Range Includes Ground
- Wide Power Supply Range: 3 to 32V±1.5 to ±16V

Voltage Reference

- Fixed Output Voltage Reference 2.5V
- 0.4% Voltage Precision
- Sink Current Capability: 1 to 100mA
- Typical Output Impedance: 0.2Ω

Package Dimensions

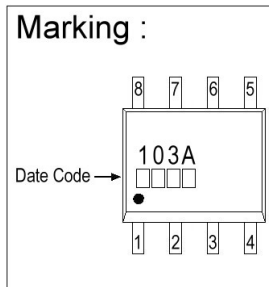
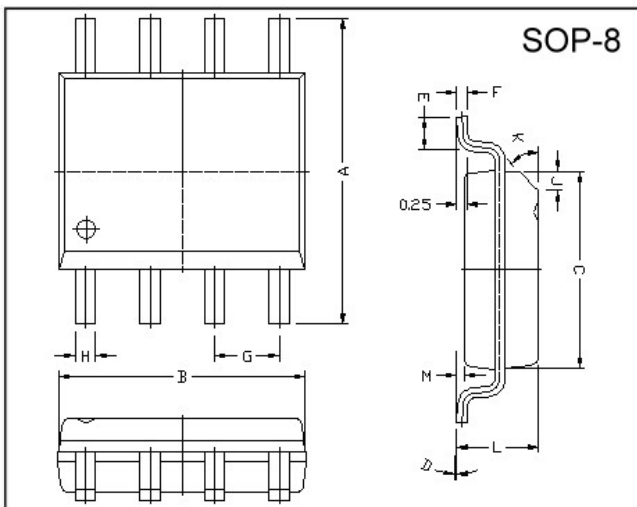

REF.	Millimeter		REF.	Millimeter	
	Min.	Max.		Min.	Max.
A	5.80	6.20	M	0.10	0.25
B	4.80	5.00	H	0.35	0.49
C	3.80	4.00	L	1.35	1.75
D	0°	8°	J	0.375 REF.	
E	0.40	0.90	K	45°	
F	0.19	0.25	G	1.27 TYP.	

Pin Connections

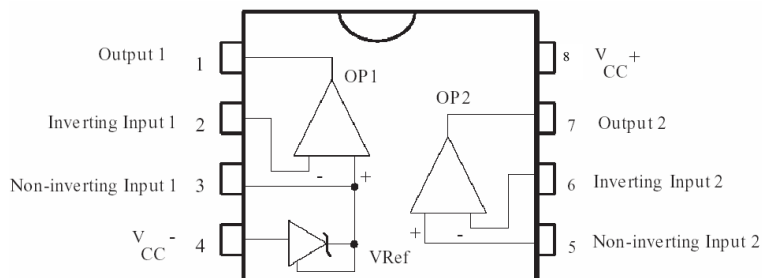

Absolute Maximum Ratings

Parameter	Symbol	Value	Unit
Supply Voltage	V _{CC}	36	V
Differential Input Voltage	V _{id}	36	V
Input Voltage	V _i	-0.3 ~ +36V	V
Maximum Junction Temperature	T _J	150	°C
Operating Ambient Temperature Range	T _{oper}	-40 ~ + 105	°C
Thermal Resistance junction Ambient Temperature	R _{θJA}	175	°C/W

Electrical Characteristics

Parameter	Symbol	Test Conditions	Min	Typ	Max	Unit
Total Supply Current, Excluding Current in the Voltage Reference	I _{CC}	V _{CC} ⁺ =5V, no load, T _{min} < T _A < T _{max}	-	0.7	1.2	mA
		V _{CC} ⁺ =30V, no load, T _{min} < T _A < T _{max}	-	-	2	mA

Operator2 (independent op-amp)V_{CC}⁺=+5V, V_{CC}=Ground, V_O=1.4V T_A=25°C (unless otherwise specified)

Parameter	Symbol	Test Conditions	Min	Typ	Max	Unit
Input Offset Voltage	V _{io}	T _A =25°C T _{min} ≤ T _A ≤ T _{max}	-	0.5	3	mV
Input Offset Voltage Drift	DV _{io}		-	7	-	uV/°C
Input Offset Current	I _{io}	T _{min} ≤ T _A ≤ T _{max}	-	2	30	nA
Input Bias Current	I _{ib}	T _{min} ≤ T _A ≤ T _{max}	-	20	150	nA
Large Signal Voltage Gain	A _{vd}	V _{CC} =15V, R _L =2k, V _O =1.4V to 11.4V T _{min} ≤ T _A ≤ T _{max}	50	100	-	V/mV
Supply Voltage Rejection Ratio	SVR	V _{CC} =5V to 30V	65	100	-	dB
Input Common Mode Voltage Range	V _{icm}	V _{CC} =+30V (note1) T _{min} ≤ T _A ≤ T _{max}	0	-	(V _{CC} ⁺)-1.5	V
Common Mode Rejection Ratio	CMR	T _{min} ≤ T _A ≤ T _{max}	70	85	-	dB
Output Current Source	I _{source}	V _{CC} =+15V, V _O =2V, V _{id} =+1V	20	40	-	mA
Short Circuit to Ground	I _o	V _{CC} =+15V	-	40	60	mA
Output Current Sink	I _{sink}	V _{CC} =+15V, V _O =2V, V _{id} =-1V	10	20	-	mA
High Level Output Voltage	V _{OH}	V _{CC} ⁺ =30V, R _L =10k, T _A =25°C T _{min} ≤ T _A ≤ T _{max}	27	28	-	V
Low Level Output Voltage	V _{OL}	R _L =10k T _{min} ≤ T _A ≤ T _{max}	-	5	20	mV
Slew Rate at Unity Gain	SR	V _i =0.5V to 3V, V _{CC} =15V, R _L =2k, C _L =100pF, Unity Gain	0.2	0.4	-	V/μs
Gain Bandwidth Product	GBP	V _{CC} =30V, R _L =2k, C _L =100pF f=100kHz, V _{in} =10mV	0.5	0.9	-	MHz
Total Harmonic Distortion	THD	V _{CC} =30V, R _L =2k, C _L =100pF V _O =2V _{PP} , f=1kHz, A _v =20dB	-	0.02	-	%

Note1: The common-mode voltage of either input signal voltage should not be allowed to go negative by more than 0.3V. The upper end of the common-mode voltage range is V_{CC}⁺ - 1.5V. But either of both input can go to +36V without damage.

Operator1 (op-amp with non-inverting input connected to the internal Vref)V_{CC}⁺=+5V, V_{CC}=Ground, V_O=1.4V T_A=25°C (unless otherwise specified)

Parameter	Symbol	Test Conditions	Min	Typ	Max	Unit
Input Offset Voltage	V _{io}	V _{icm} =0V, T _A =25°C T _{min} ≤ T _A ≤ T _{max}	-	0.5	3	mV
Input Offset Voltage Drift	DV _{io}		-	7	-	uV/°C
Input Bias Current	I _{ib}	Negative input	-	20	-	nA
Large Signal Voltage Gain	A _{vd}	V _{icm} =0V V _{CC} =15V, R _L =2k	-	100	-	V/mV
Supply Voltage Rejection Ratio	SVR	V _{icm} =0V V _{CC} ⁺ =5V to 30V	65	100	-	dB
Output Current Source	I _{source}	V _{CC} =+15V, V _O =2V, V _{id} =+1V	20	40	-	mA
Short Circuit to Ground	I _o	V _{CC} =+15V	-	40	60	mA
Output Current Sink	I _{sink}	V _{CC} =+15V, V _O =2V, V _{id} =-1V	10	20	-	mA
High Level Output Voltage	V _{OH}	V _{CC} ⁺ =30V, R _L =10k, T _A =25°C T _{min} ≤ T _A ≤ T _{max}	27	28	-	V
Low Level Output Voltage	V _{OL}	R _L =10k T _{min} ≤ T _A ≤ T _{max}	-	5	20	mV
Slew Rate at Unity Gain	SR	V _i =0.5V to 2V, V _{CC} =15V, R _L =2k, C _L =100pF, Unity Gain	0.2	0.4	-	V/μs
Gain Bandwidth Product	GBP	V _{CC} =30V, R _L =2k, C _L =100pF f=100kHz, V _{in} =10mV	0.5	0.9	-	MHz
Total Harmonic Distortion	THD	V _{CC} =30V, R _L =2k, C _L =100pF V _O =2V _{PP} , f=1kHz, A _v =20dB	-	0.02	-	%

Voltage Reference

Parameter	Symbol	Test Conditions	Value	Unit
Cathode Current	I _k		1 to 100	mA

Parameter	Symbol	Test Conditions	Min	Typ	Max	Unit
Reference Input Voltage	V _{ref}	T _A =25°C T _{min} ≤ T _A ≤ T _{max}	2.49	2.5	2.51	V
Reference Input Voltage Deviation Over Temp. Range	ΔV _{ref}	V _{KA} =V _{ref} , I _k =10mA, T _{min} ≤ T _A ≤ T _{max}	-	5	24	mV
Minimum Cathode Current for Regulation	I _{min}	V _{KA} =V _{ref}	-	0.5	1	mA
Dynamic Impedance (note2)	Z _{KA}	V _{KA} =V _{ref} , ΔI _k =1 to 100mA, f<1kHz	-	0.2	0.5	Ω

Note2: The Dynamic impedance is defined as $|Z_{KA}| = \Delta V_{KA} / \Delta I_k$

Characteristics Curve

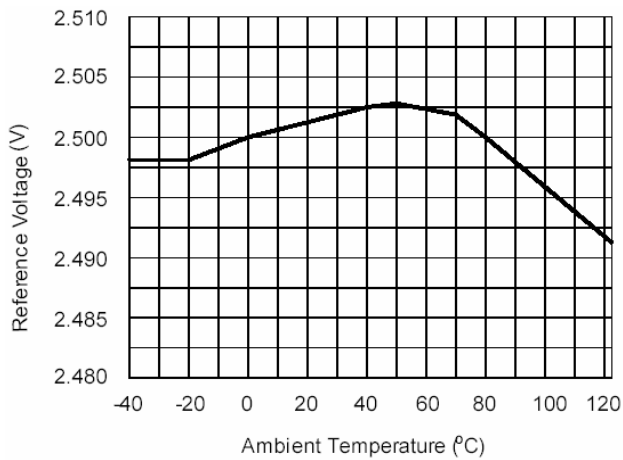

Fig 1. Reference Voltage vs. Ambient Temperature

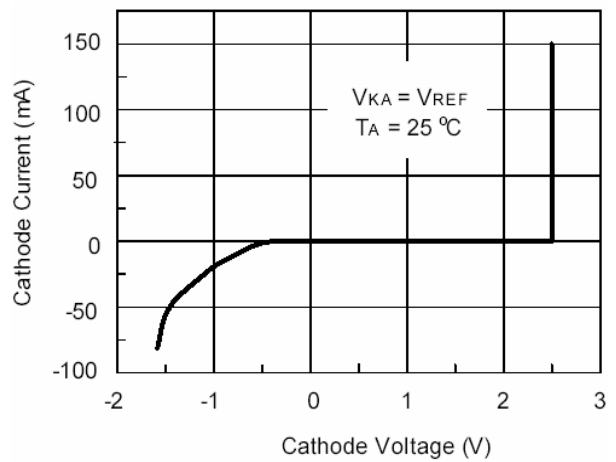

Fig 2. Cathode Current vs. Cathode Voltage

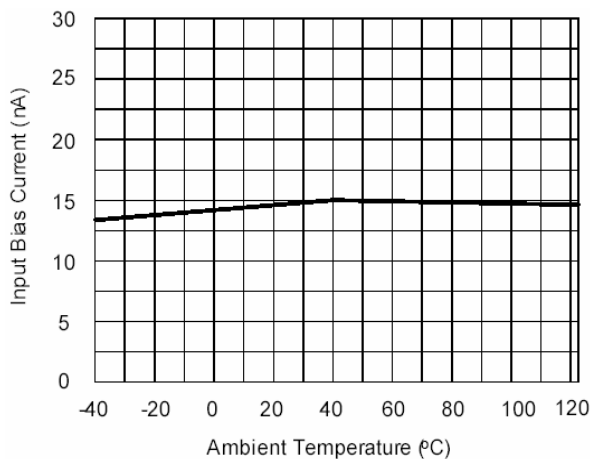

Fig 3. Input Bias Current vs. Ambient Temperature

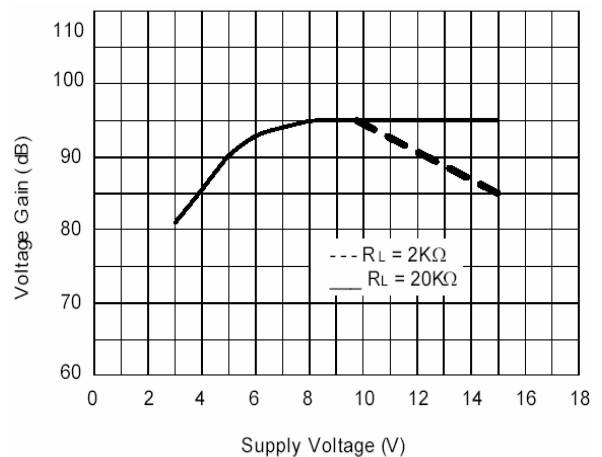

Fig 4. Operational Amplifier Voltage Gain

Important Notice:

- All rights are reserved. Reproduction in whole or in part is prohibited without the prior written approval of GTM.
- GTM reserves the right to make changes to its products without notice.
- GTM semiconductor products are not warranted to be suitable for use in life-support Applications, or systems.
- GTM assumes no liability for any consequence of customer product design, infringement of patents, or application assistance.

Head Office And Factory:

- **Taiwan:** No. 17-1 Tatung Rd. Fu Kou Hsin-Chu Industrial Park, Hsin-Chu, Taiwan, R. O. C.
TEL : 886-3-597-7061 FAX : 886-3-597-9220, 597-0785
- **China:** (201203) No.255, Jang-Jiang Tsai-Lueng RD. , Pu-Dung-Hsin District, Shang-Hai City, China
TEL : 86-21-5895-7671 ~ 4 FAX : 86-21-38950165