

GSC1384 NPN EPITAXIAL PLANAR TRANSISTOR

Description

The GSC1384 is designed for power amplifier and driver.

Features

*Low collector to emitter saturation voltage $V_{CE(sat)}$.

*Complementary pair with GSA684

Package Dimensions

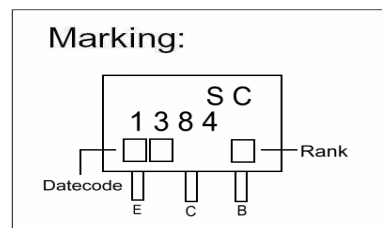
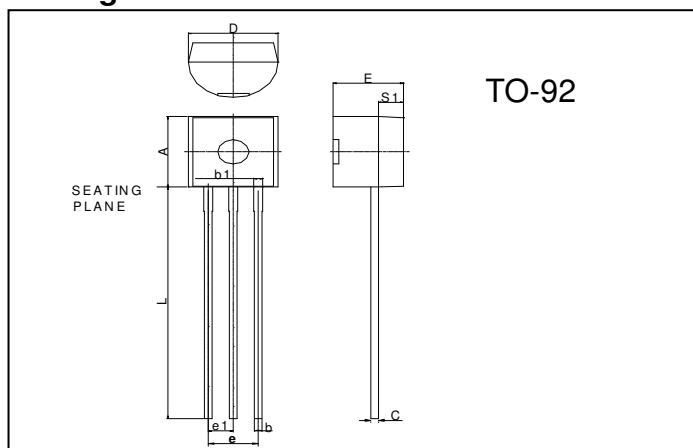

REF.	Millimeter		REF.	Millimeter	
	Min.	Max.		Min.	Max.
A	4.45	4.7	D	4.44	4.7
S1	1.02	-	E	3.30	3.81
b	0.36	0.51	L	12.70	-
b1	0.36	0.76	e1	1.150	1.390
C	0.36	0.51	e	2.42	2.66

Absolute Maximum Ratings (Ta = 25°C, unless otherwise specified)

Parameter		Ratings	Unit
Collector to Base Voltage	VCBO	60	V
Collector to Emitter Voltage	VCEO	50	V
Emitter to Base Voltage	VEBO	5	V
Collect Current(DC)	IC	1	A
Collect Current*(Pulse)	ICP	1.5	A
Junction Temperature	Tj	+150	°C
Storage Temperature Range	TSTG	-55 ~ +150	°C
Total Power Dissipation	PD	1	W

Electrical Characteristics (Ta = 25°C, unless otherwise specified)

Symbol	Min.	Typ.	Max.	Unit	Test Conditions
VCBO	60	-	-	V	IC=10uA, IE=0
VCEO	50	-	-	V	IC=2mA, IB=0
VEBO	5	-	-	V	IE=10uA, IC=0
ICBO	-	-	0.1	uA	VCB=20V, IE=0
VCE(sat)	-	200	400	mV	IC=0.5A, IB=50mA(note)
VBE(sat)	-	0.85	1.2	V	IC=0.5A, IB=50mA(note)
*hFE1	85	160	340		VCE=10V, IC=500mA(note)
*hFE2	50	100	-		VCE=5V, IC=1A(note)
fT	-	200	-	MHz	VCE=10V, IB=-50mA, f=200MHz
Cob	-	11	20	pF	VCB=10V, IE=0, f=1MHz

Note: Pulse measurement

Classification Of hFE1

Rank	Q	R	S
Range	85-170	120-240	170-340

Characteristics Curve

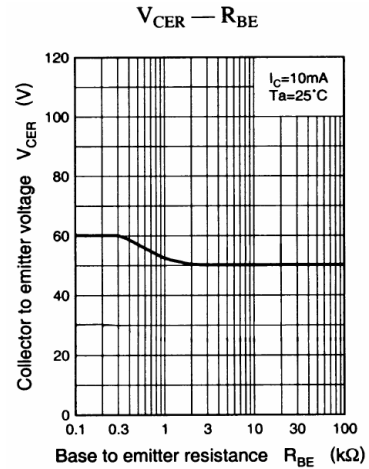
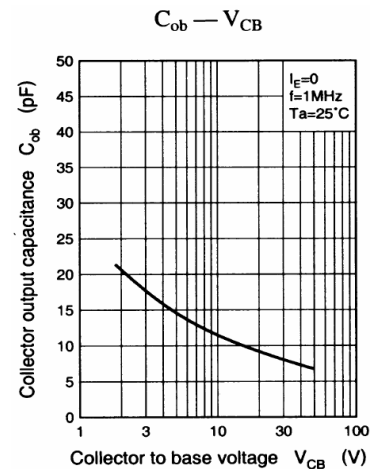
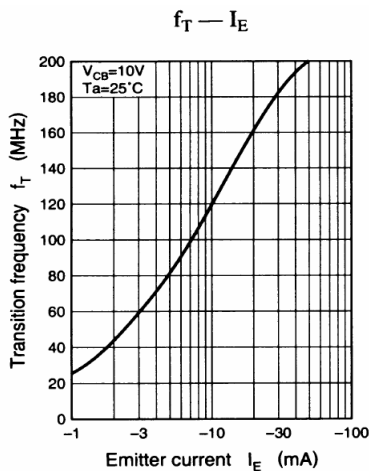
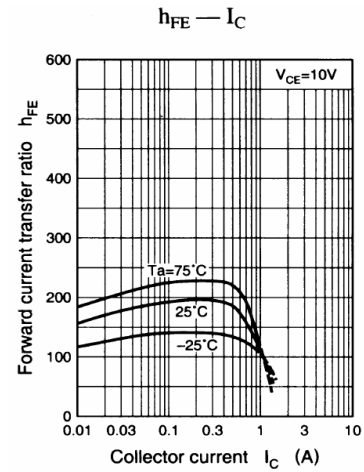
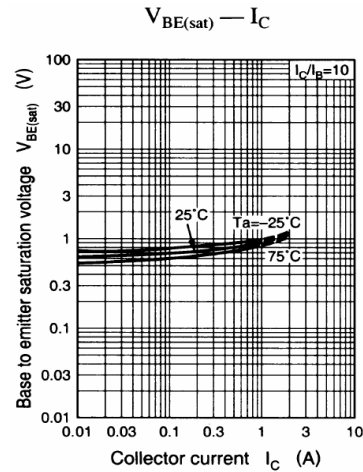
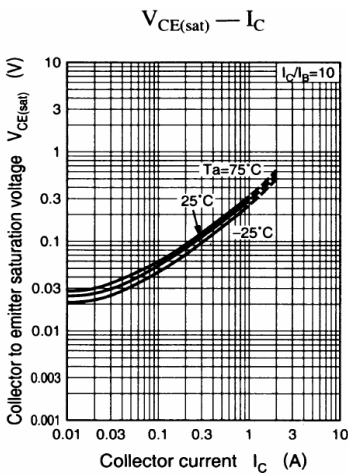
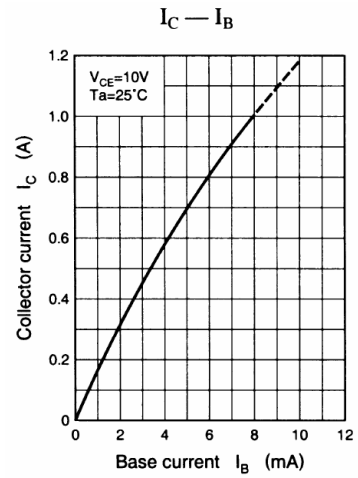
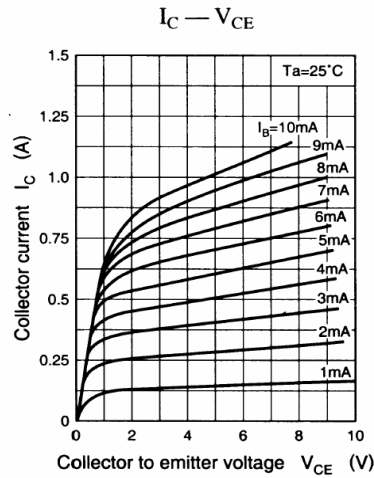
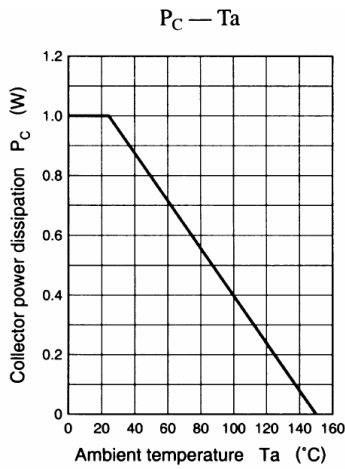

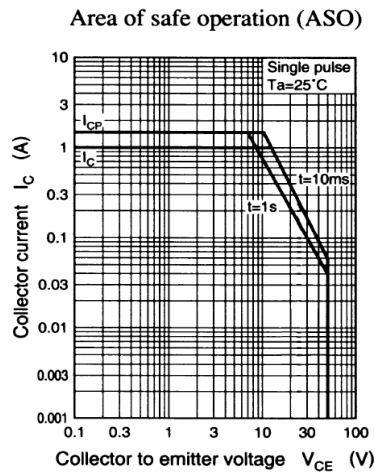
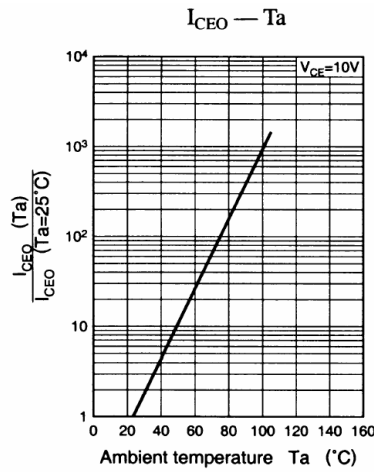

Important Notice:

- All rights are reserved. Reproduction in whole or in part is prohibited without the prior written approval of GTM.
- GTM reserves the right to make changes to its products without notice.
- GTM semiconductor products are not warranted to be suitable for use in life-support Applications, or systems.
- GTM assumes no liability for any consequence of customer product design, infringement of patents, or application assistance.

Head Office And Factory:

- **Taiwan:** No. 17-1 Tatung Rd. Fu Kou Hsin-Chu Industrial Park, Hsin-Chu, Taiwan, R. O. C.
- TEL : 886-3-597-7061 FAX : 886-3-597-9220, 597-0785
- **China:** (201203) No.255, Jang-Jiang Tsai-Lueng RD. , Pu-Dung-Hsin District, Shang-Hai City, China
- TEL : 86-21-5895-7671 ~ 4 FAX : 86-21-38950165