

GSC1473A NPN SILICON TRANSISTOR

Description

The GSC1473A is designed for general amplification.

Features

- High Collector to Emitter Voltage V_{CE0}
- High Transition Frequency f_T

Package Dimensions

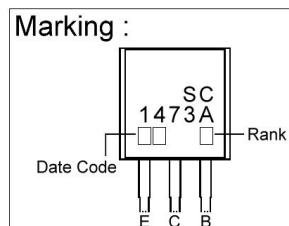
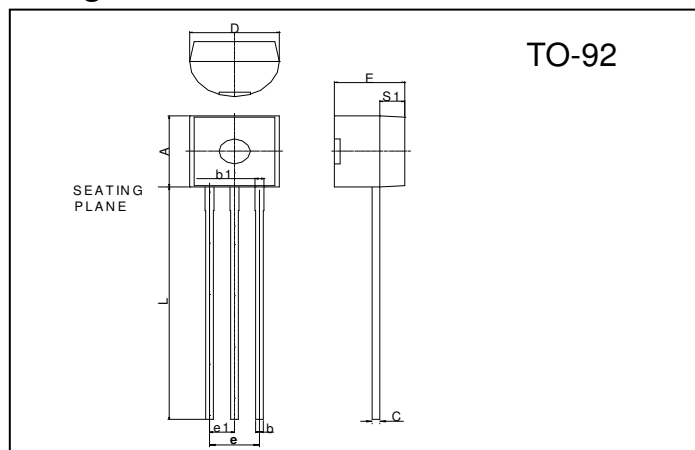

REF.	Millimeter		REF.	Millimeter	
	Min.	Max.		Min.	Max.
A	4.45	4.7	D	4.44	4.7
S1	1.02	-	E	3.30	3.81
b	0.36	0.51	L	12.70	-
b1	0.36	0.76	e1	1.150	1.390
C	0.36	0.51	e	2.42	2.66

Absolute Maximum Ratings ($T_A=25^\circ\text{C}$)

Parameter	Symbol	Ratings	Unit
Collector to Base Voltage	V_{CBO}	300	V
Collector to Emitter Voltage	V_{CEO}	300	V
Emitter to Base Voltage	V_{EBO}	7	V
Peak Collector Current	I_{CP}	100	mA
Collector Current (continuous)	I_C	70	mA
Total Device Dissipation	P_D	750	mW
Junction Temperature	T_J	150	$^\circ\text{C}$
Storage Temperature	T_{stg}	-55 ~ +150	$^\circ\text{C}$

Electrical Characteristics ($T_A = 25^\circ\text{C}$ unless otherwise noted)

Symbol	Min.	Typ.	Max.	Unit	Test Conditions
BV_{CBO}	300	-	-	V	$I_C=100\mu\text{A}$, $I_E=0$
BV_{CEO}	300	-	-	V	$I_C=1\text{mA}$, $I_B=0$
BV_{EBO}	7	-	-	V	$I_E=1\mu\text{A}$, $I_C=0$
I_{CEO}	-	-	1	μA	$V_{CE}=120\text{V}$
$V_{CE(sat)}$	-	-	1.2	V	$I_C=50\text{mA}$, $I_B=5\text{mA}$
h_{FE}	30	-	220		$V_{CE}=10\text{V}$, $I_C=5\text{mA}$
f_T	50	80	-	MHz	$V_{CE}=10\text{V}$, $I_C=10\text{mA}$, $f=200\text{MHz}$
C_{ob}	-	-	10	pF	$V_{CB}=10\text{V}$, $f=1\text{MHz}$

Classification Of h_{FE}

Rank	P	Q	R
h_{FE}	30 ~ 100	60 ~ 150	100 ~ 220

Characteristics Curve

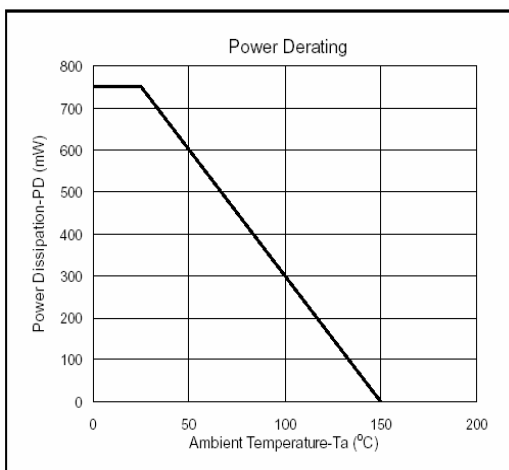
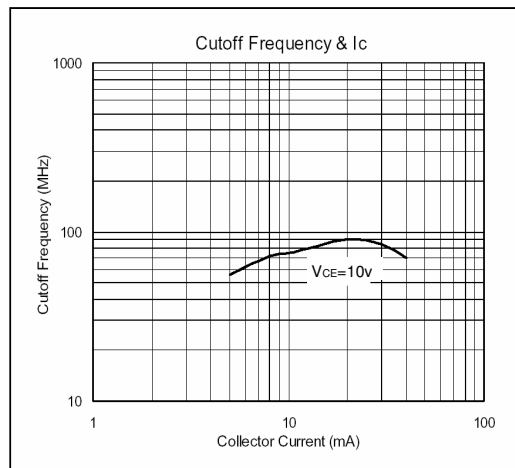
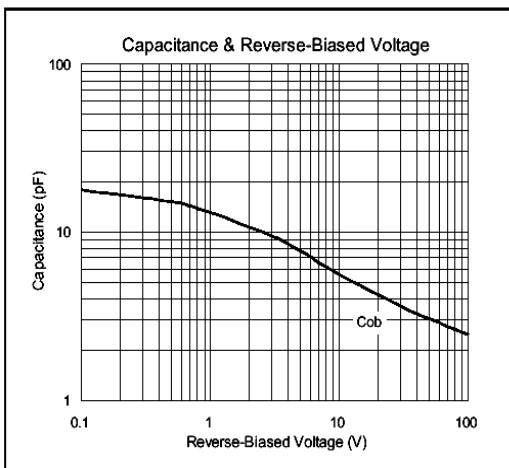
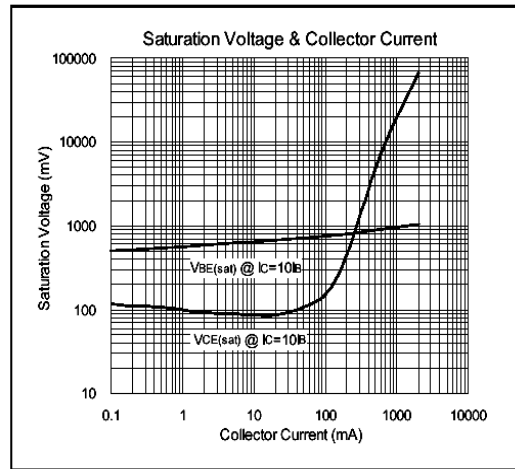
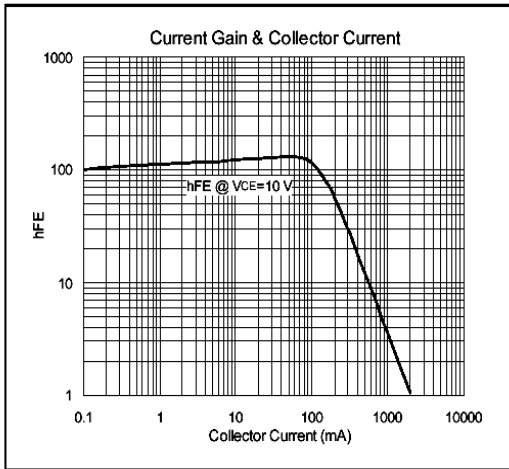

Important Notice:

- All rights are reserved. Reproduction in whole or in part is prohibited without the prior written approval of GTM.
- GTM reserves the right to make changes to its products without notice.
- GTM semiconductor products are not warranted to be suitable for use in life-support Applications, or systems.
- GTM assumes no liability for any consequence of customer product design, infringement of patents, or application assistance.

Head Office And Factory:

- **Taiwan:** No. 17-1 Tatung Rd. Fu Kou Hsin-Chu Industrial Park, Hsin-Chu, Taiwan, R. O. C.
 TEL : 886-3-597-7061 FAX : 886-3-597-9220, 597-0785
- **China:** (201203) No.255, Jang-Jiang Tsai-Lueng RD. , Pu-Dung-Hsin District, Shang-Hai City, China
 TEL : 86-21-5895-7671 ~ 4 FAX : 86-21-38950165