

# GSC4409

## P-CHANNEL ENHANCEMENT MODE POWER MOSFET

BVDSS	-30V
RDS(ON)	7.5mΩ
ID	-15A

### Description

The GSC4409 uses advanced trench technology to provide excellent on-resistance and ultra low gate charge. The SOP-8 package is universally preferred for all commercial-industrial surface mount applications and suited for use as a load switch or in PWM applications.

### Features

- \*Simple Drive Requirement
- \*Lower On-resistance
- \*Fast Switching Characteristic

### Package Dimensions

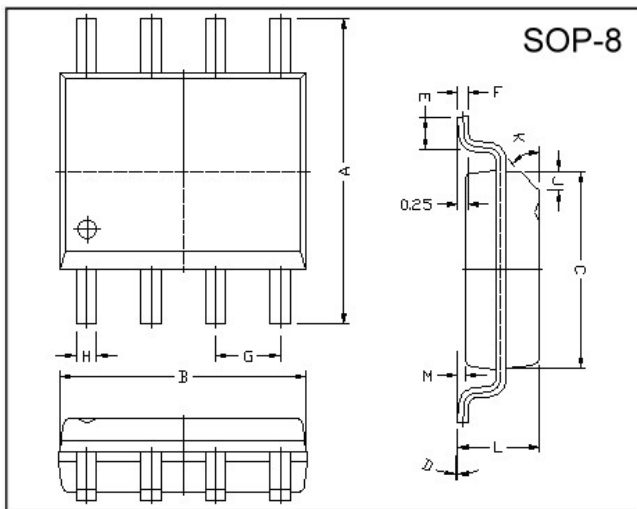

### Marking :

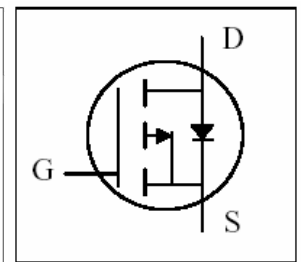
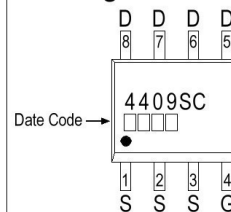

REF.	Millimeter		REF.	Millimeter	
	Min.	Max.		Min.	Max.
A	5.80	6.20	M	0.10	0.25
B	4.80	5.00	H	0.35	0.49
C	3.80	4.00	L	1.35	1.75
D	0°	8°	J	0.375 REF.	
E	0.40	0.90	K	45°	
F	0.19	0.25	G	1.27 TYP.	

### Absolute Maximum Ratings

Parameter	Symbol	Ratings	Unit
Drain-Source Voltage	$V_{DS}$	-30	V
Gate-Source Voltage	$V_{GS}$	$\pm 20$	V
Continuous Drain Current <sup>3</sup>	$I_D @ TA=25^\circ C$	-15	A
Continuous Drain Current <sup>3</sup>	$I_D @ TA=70^\circ C$	-12.8	A
Pulsed Drain Current <sup>1</sup>	$I_{DM}$	-80	A
Total Power Dissipation	$P_D @ TA=25^\circ C$	2.5	W
Linear Derating Factor		0.02	W/°C
Operating Junction and Storage Temperature Range	$T_j, T_{stg}$	-55 ~ +150	°C

### Thermal Data

Parameter	Symbol	Value	Unit
Thermal Resistance Junction-ambient <sup>3</sup> Max.	$R_{thj-amb}$	50	°C/W

**Electrical Characteristics (T<sub>j</sub> = 25°C unless otherwise specified)**

Parameter	Symbol	Min.	Typ.	Max.	Unit	Test Conditions
Drain-Source Breakdown Voltage	BV <sub>DSS</sub>	-30	-	-	V	V <sub>GS</sub> =0, I <sub>D</sub> =-250uA
Gate Threshold Voltage	V <sub>GS(th)</sub>	-1.4	-	-2.7	V	V <sub>DS</sub> =V <sub>GS</sub> , I <sub>D</sub> =-250uA
Forward Transconductance	g <sub>fs</sub>	-	50	-	S	V <sub>DS</sub> =-5V, I <sub>D</sub> =-15A
Gate-Source Leakage Current	I <sub>GSS</sub>	-	-	±100	nA	V <sub>GS</sub> = ±20V
Drain-Source Leakage Current(T <sub>j</sub> =25°C)	I <sub>DSS</sub>	-	-	-5	uA	V <sub>DS</sub> =-30V, V <sub>GS</sub> =0
Drain-Source Leakage Current(T <sub>j</sub> =55°C)		-	-	-25	uA	V <sub>DS</sub> =-24V, V <sub>GS</sub> =0
Static Drain-Source On-Resistance <sup>2</sup>	R <sub>DS(ON)</sub>	-	-	7.5	mΩ	V <sub>GS</sub> =-10V, I <sub>D</sub> =-15A
		-	-	12		V <sub>GS</sub> =-4.5V, I <sub>D</sub> =-10A
Total Gate Charge <sup>2</sup>	Q <sub>g</sub>	-	100	120	nC	I <sub>D</sub> =-15A V <sub>DS</sub> =-15V V <sub>GS</sub> =-10V
Gate-Source Charge	Q <sub>gs</sub>	-	14.5	-		
Gate-Drain ("Miller") Change	Q <sub>gd</sub>	-	23	-		
Turn-on Delay Time <sup>2</sup>	T <sub>d(on)</sub>	-	14	-	ns	V <sub>DS</sub> =-15V V <sub>GS</sub> =-10V R <sub>G</sub> =3Ω R <sub>L</sub> =1Ω
Rise Time	T <sub>r</sub>	-	16.5	-		
Turn-off Delay Time	T <sub>d(off)</sub>	-	76.5	-		
Fall Time	T <sub>f</sub>	-	37.5	-		
Input Capacitance	C <sub>iss</sub>	-	5270	6400	pF	V <sub>GS</sub> =0V V <sub>DS</sub> =-15V f=1.0MHz
Output Capacitance	C <sub>oss</sub>	-	945	-		
Reverse Transfer Capacitance	C <sub>rss</sub>	-	745	-		

**Source-Drain Diode**

Parameter	Symbol	Min.	Typ.	Max.	Unit	Test Conditions
Forward On Voltage <sup>2</sup>	V <sub>SD</sub>	-	-	-1.0	V	I <sub>S</sub> =-1.0A, V <sub>GS</sub> =0V
Continuous Source Current (Body Diode)	I <sub>S</sub>	-	-	-5	A	V <sub>D</sub> = V <sub>G</sub> =0V, V <sub>S</sub> =-1.0V
Reverse Recovery Time <sup>2</sup>	T <sub>rr</sub>	-	36.7	-	ns	I <sub>S</sub> =-15A, V <sub>GS</sub> =0V di/dt=100A/μs
Reverse Recovery Charge	Q <sub>rr</sub>	-	28	-	nC	

Notes: 1. Pulse width limited by Max. junction temperature.

2. Pulse width ≤ 300us, duty cycle ≤ 2%.

3. Surface mounted on 1 in<sup>2</sup> copper pad of FR4 board; 125°C/W when mounted on Min. copper pad.

**Characteristics Curve**

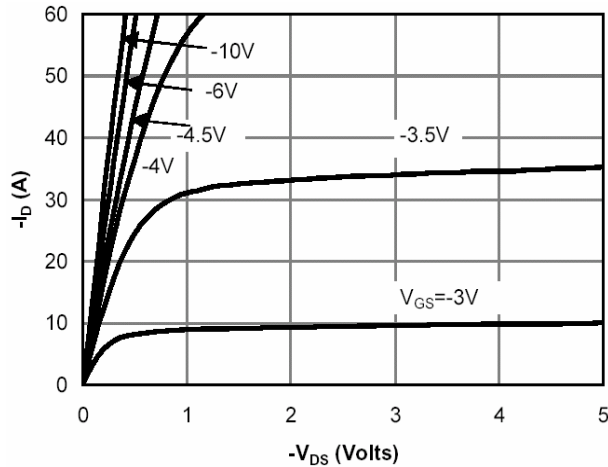

**Fig 1. Typical Output Characteristics**

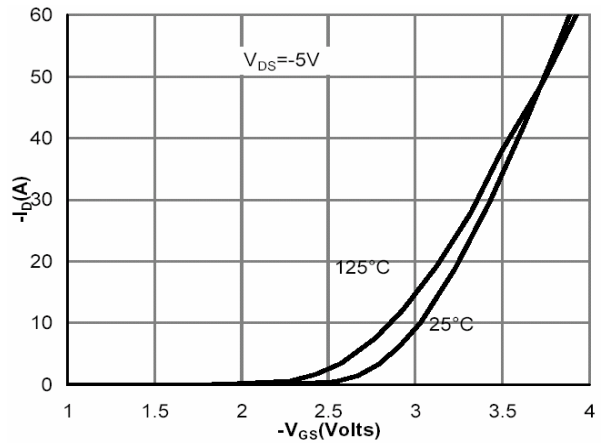

**Fig 2. Transfer Characteristics**

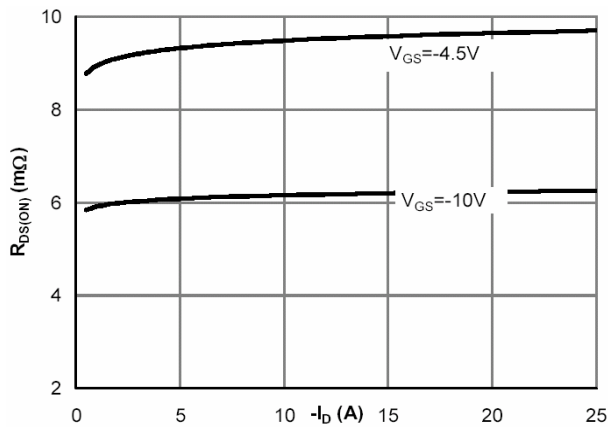

**Fig 3. On-Resistance v.s. Drain Current and Gate Voltage**

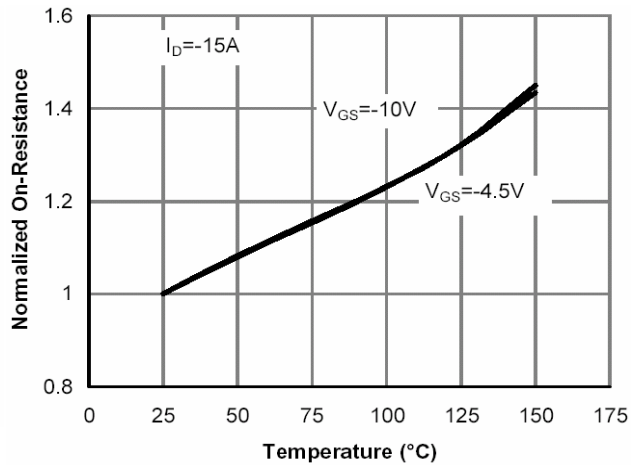

**Fig 4. On-Resistance v.s. Junction Temperature**

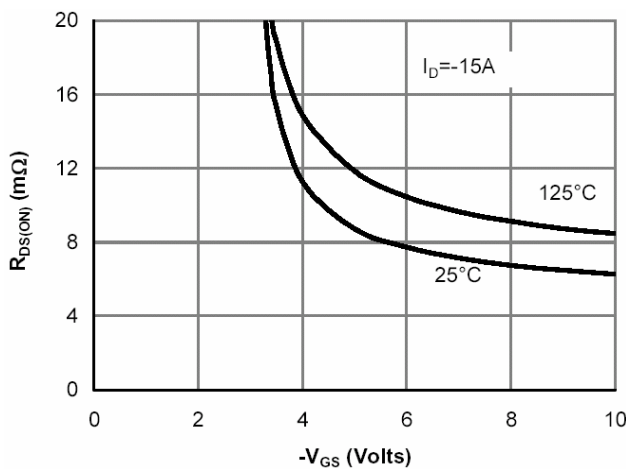

**Fig 5. On-Resistance v.s. Gate-Source Voltage**

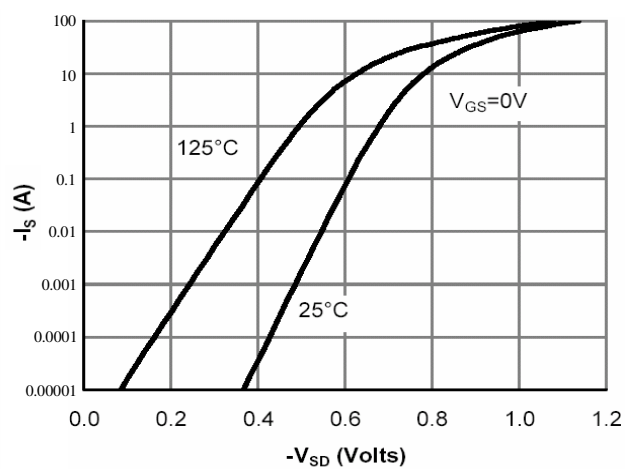

**Fig 6. Body Diode Characteristics**

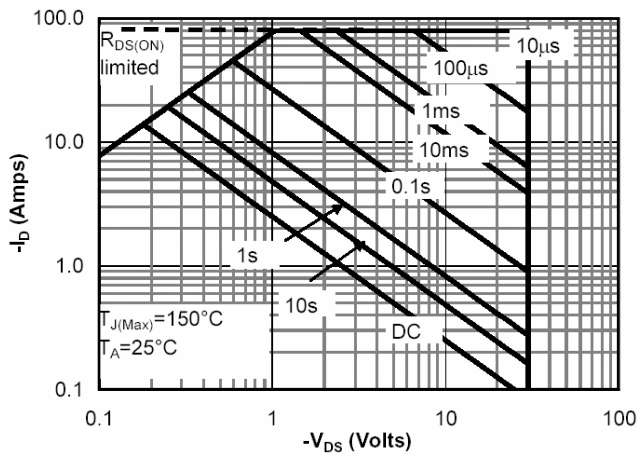

**Fig 7. Maximum Safe Operating Area**

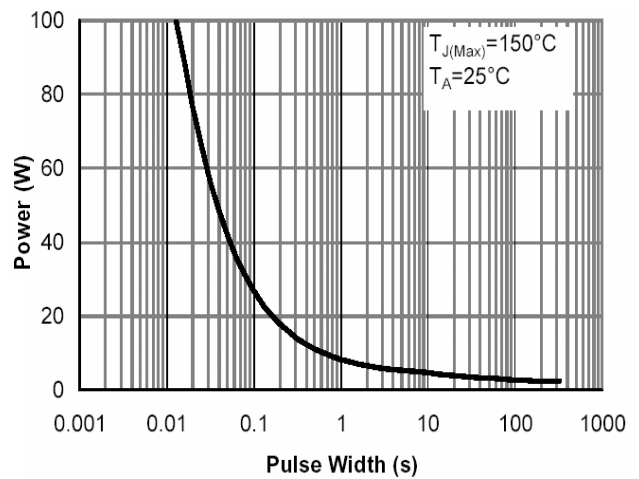

**Fig 8. Single Pulse Maximum Power Dissipation**

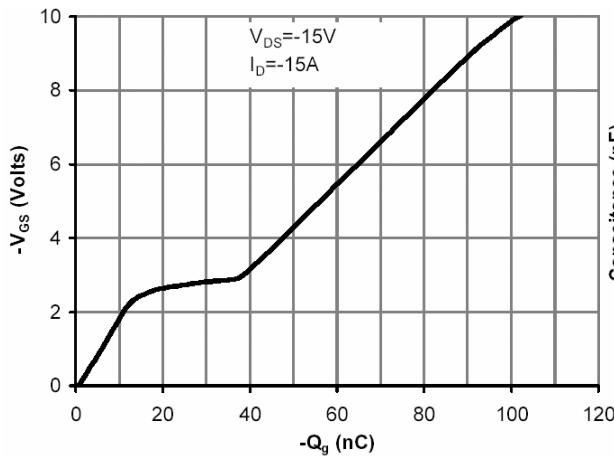

**Fig 9. Gate Charge Characteristics**

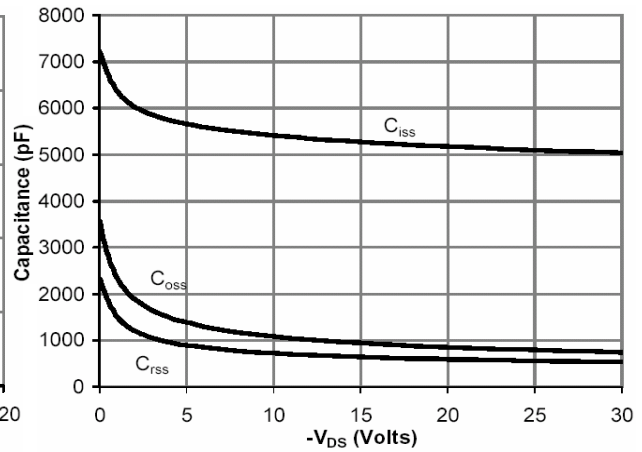

**Fig 10. Typical Capacitance Characteristics**

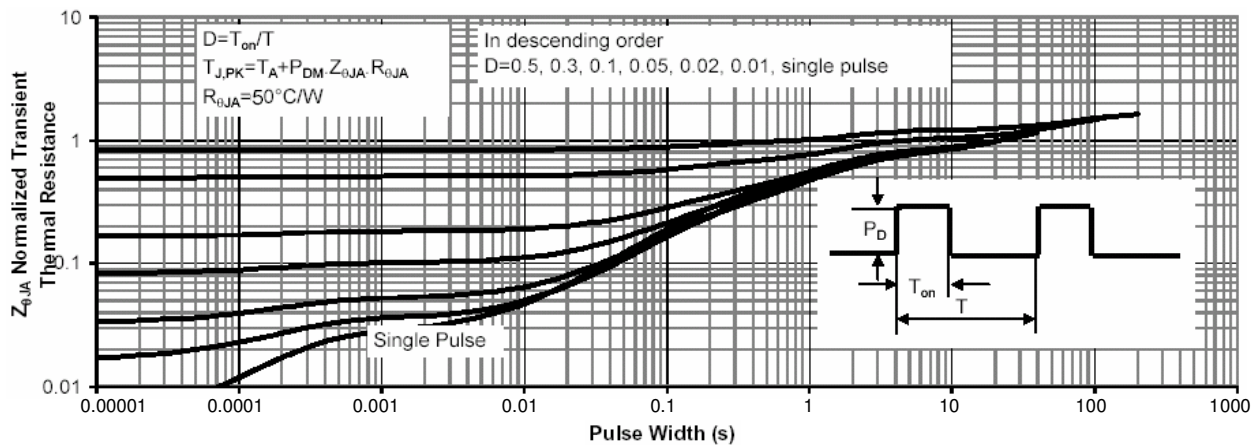

**Fig 11. Normalized Maximum Transient Thermal Impedance**

**Important Notice:**

- All rights are reserved. Reproduction in whole or in part is prohibited without the prior written approval of GTM.
- GTM reserves the right to make changes to its products without notice.
- GTM semiconductor products are not warranted to be suitable for use in life-support Applications, or systems.
- GTM assumes no liability for any consequence of customer product design, infringement of patents, or application assistance.

**Head Office And Factory:**

- Taiwan:** No. 17-1 Tatung Rd. Fu Kou Hsin-Chu Industrial Park, Hsin-Chu, Taiwan, R. O. C.
- TEL : 886-3-597-7061 FAX : 886-3-597-9220, 597-0785
- China:** (201203) No.255, Jang-Jiang Tsai-Lueng RD. , Pu-Dung-Hsin District, Shang-Hai City, China
- TEL : 86-21-5895-7671 ~ 4 FAX : 86-21-38950165